

EASEMENT

WHEREAS, CLC-NISI Joint Venture, a joint venture organized under and subject to the Uniform Partnership Act of Nebraska, which joint venture is composed of Nebraska Investment Services, Inc., a Nebraska corporation, and Creative Land Consultants, Inc., a Nebraska corporation (said joint venture being herein referred to as the "Grantor") desires to grant a perpetual easement for an underground telephone cable over certain property owned by the Grantor to North-western Bell Telephone Company (herein collectively referred to as the "Grantee" except as otherwise noted),

NOW, THEREFORE, in consideration of One Dollar and other valuable consideration, receipt of which is hereby acknowledged, the Grantor being the owner of the property described in Exhibits "1" through "4" does herewith give and grant unto the Grantee, its successors and assigns, a perpetual easement for an underground telephone cable over, on, across, under the property as shown on Exhibits "1" through "4" attached hereto and incorporated herein by reference as all set out herein.

1. The scope and purpose of the easement is for the construction, repair, maintenance, replacement and renewal of telephone cable lines, including all necessary and related appurtenances. The Grantee shall have the full right and authority to enter upon said easement way in order to perform any of the acts and functions described within the scope and purpose of said easement.

2. By accepting and recording this perpetual easement, said Grantee agrees to make good or cause to be made good to the owner or owners of the property in which the same were constructed, any or all damage that may be done by reason of negligent changes, alterations, maintenance, inspection, repairs or construction in the way of damage to trees, grounds, buildings or other improvements abutting thereon, including crops, vines and gardens; provided, however, that this provision does not apply to any of the aforesaid located in, on, over or across said easement or any part thereof.

3. Grantor herein for itself, its successors and assigns, does hereby covenant and agree with the said Grantee and its successors and assigns that at the time of the execution and delivery of these presents, Grantor is lawfully seized of such premises, that the Grantor has good right and lawful authority to grant said easement way, and that the Grantor further hereby covenants to warrant and defend said easement way against the lawful claims of all persons whomsoever.

4. This Easement shall be binding upon and shall benefit and run to the successors and assigns of the respective parties hereto.

D

it

D  
at

Index  
Comped  
83-64573  
352

5. The Grantee clearly understands and agrees that its use of said easement shall be concurrent with any easements granted for an underground electrical cable to the power company.

IN WITNESS WHEREOF, the Grantor herein, for itself, its successors and assigns, has caused the due execution hereof as of the date and year first above written.

CLC-NISI JOINT VENTURE, a Joint Venture organized under and subject to the Uniform Partnership Act of Nebraska

By: NEBRASKA INVESTMENT SERVICES, INC. a Nebraska corporation

By: C.E. Westphal C.E. Westphal, President



ATTEST:

Charles B. Stilwell

By: CREATIVE LAND CONSULTANTS, INC. a Nebraska corporation,

By: Glenn L. Buck Glenn L. Buck, President

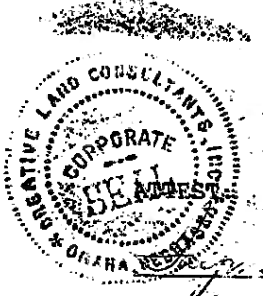

Glenn L. Buck

(Being all of the members of CLC-NISI Joint Venture)

STA  
COU  
  
und  
cam  
per  
who  
led  
suc  
COR  
the  
sea  
★  
and  
  
STA  
COU  
  
und  
cam  
per  
who  
led  
suc  
COR  
the  
sea  
  
and

STATE OF NEBRASKA )  
 ) SS.  
COUNTY OF DOUGLAS )

On this 15 day of December, 1976, before me, the undersigned a Notary Public in and for said county, personally came C.E. Westphal, President of Nebraska Investment Services, Inc., personally known to me to be the President and identical person whose name was affixed to the foregoing instrument and he acknowledged the execution thereof to be his voluntary act and deed as such person, his voluntary act and deed as the officer of said corporation, the voluntary act and deed of said corporation, and the voluntary act and deed of said joint venture, and the corporate seal of said corporation was affixed thereto by its authority.

Witness my hand and notarial seal in said county the day and year first above written.



Evelyn M. Oswald  
Notary Public

STATE OF NEBRASKA )  
 ) SS.  
COUNTY OF DOUGLAS )

On this 14 day of December, 1976, before me, the undersigned a Notary Public in and for said county, personally came Glenn L. Buck, President of Creative Land Consultants, Inc., personally known to me to be the President and identical person whose name is affixed to the foregoing instrument and he acknowledged the execution thereof to be his voluntary act and deed as such person, his voluntary act and deed as the officer of said corporation, the voluntary act and deed of said corporation, and the voluntary act and deed of said joint venture, and the corporate seal of said corporation was affixed thereto by its authority.

Witness my hand and notarial seal in said county the day and year first above written.

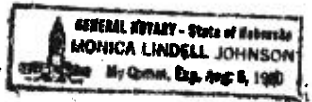

Monica Lindell Johnson  
Notary Public

ts  
ited

ts  
of



NC.

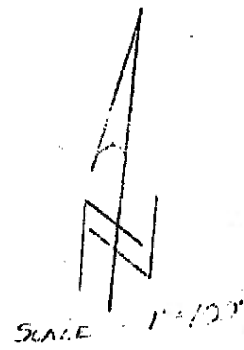
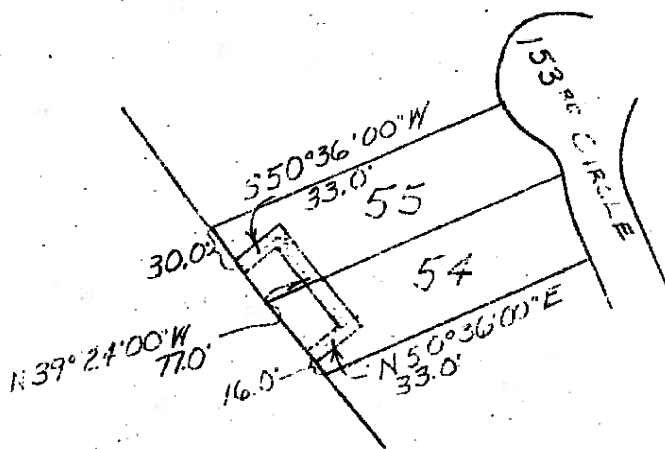

N 39° 24' 00"

**Permanent Utilities Easement**

The following is a legal description of a Permanent Utilities Easement in Harvey Oaks III, a subdivision in Douglas County, Nebraska. Said Easement being 10 feet in width and lying 5 feet on both sides of a line described as follows:

Beginning at a point on the southwesterly line of Lot 54 of said Harvey Oaks said point being 16.0 feet northwesterly of the southwest corner of said Lot 54; thence north 50°36'00" east (assumed bearing) along the center line of said easement a distance of 33.0 feet; thence north 39°24'00" west to a point on the northwesterly line of said Lot 54 and the terminal point of said easement.

in H  
Ease  
line

Harv  
corn  
alon  
sout  
55 a

11/23/76

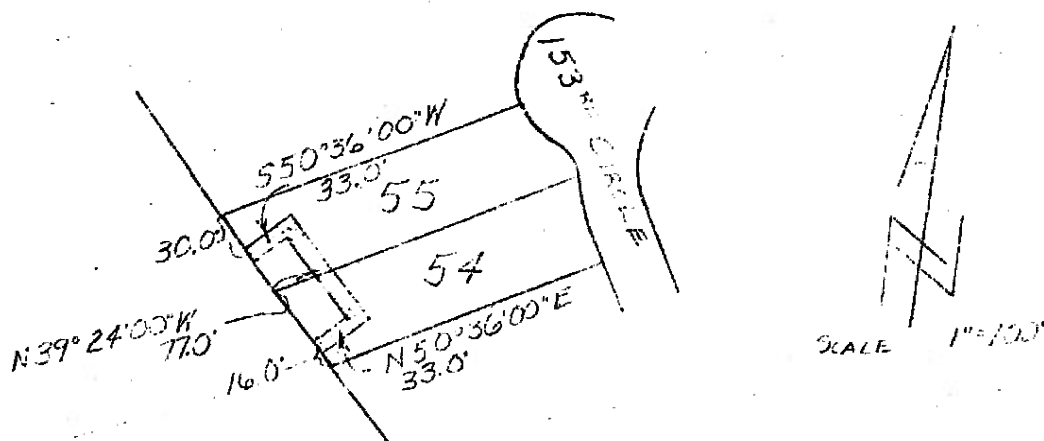

**Permanent Utilities Easement**

The following is a legal description of a Permanent Utilities Easement in Harvey Oaks III, a subdivision in Douglas County, Nebraska. Said Easement being 10 feet in width and lying 5 feet on both sides of a line described as follows:

Beginning at a point on the southwesterly line of Lot 55 of said Harvey Oaks said point being 30.0 feet southeasterly of the northwest corner of said Lot 55; thence north 50°36'00" east (assumed bearing) along the center line of said easement a distance of 33.0 feet; thence south 39°24'00" east, to a point on the southeasterly line of said Lot 55 and the terminal point of said easement.

11/23/76

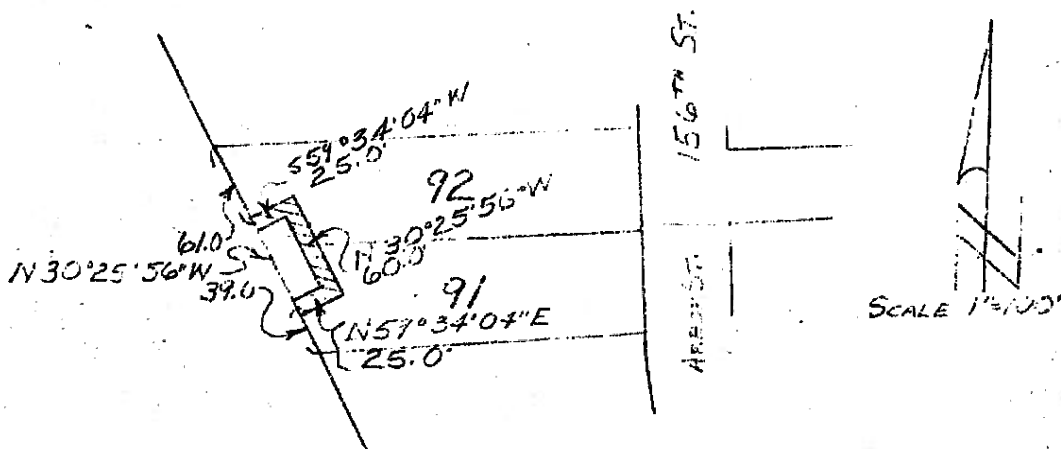

Permanent Utilities Easement

The following is a legal description of a Permanent Utilities Easement in Harvey Oaks III, a subdivision in Douglas County, Nebraska. Said Easement being 10 feet in width and lying 5 feet on both sides of a line described as follows:

Beginning at a point on the southwesterly line of Lot 91 of said Harvey Oaks said point being 39.0 feet northwesterly from the southwesterly corner of said Lot 91; thence north 59°34'04" east (assumed bearing) along the centerline of said easement a distance of 25.0 feet; thence north 30°25'56" west to a point of the north line of said Lot 91 and the terminal point of said easement.

11/23/76

7<sup>th</sup> Floor

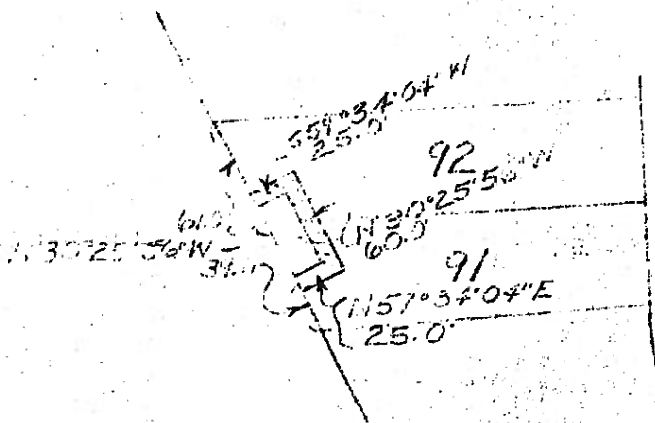
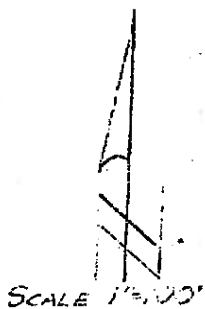

Permanent Utilities Easement

The following is a legal description of a Permanent Utilities Easement in Harvey Oaks III, a subdivision in Douglas County, Nebraska. Said Easement being 10 feet in width and lying 5 feet on both sides of a line described as follows:

Beginning at a point on the southwesterly line of Lot 92 of said Harvey Oaks said point being 61.0 feet southeasterly of the northwest corner of said Lot 92; thence north 59°34'04" east (assumed bearing) along the center line of said easement a distance of 25.0 feet; thence south 30°25'56" east to a point on the south line of said Lot 92 and the terminal point of said easement.

Utilities Easement  
Nebraska. Said  
sides of a

at 91 of said  
the southwesterly  
bearing) along  
thence north  
and the terminal

*7' Road*

RECEIVED  
DEC 21 1976

Book 574  
Page 331  
of 1000

11/23/76

Index

Comped

11/23/76