

RECEIVED
Aug. 29

This instrument after recording
to be returned to:

Aug 28 8 41 AM '97

Daniel B. Kinnamon
Erickson & Sederstrom
Regency Westpointe
10330 Regency Parkway Drive
Omaha, NE 68114

RICHARD N. TAKECHI
REGISTER OF DEEDS
DOUGLAS COUNTY, NE



(Space Above This Line for Recording Data)

PERMANENT SEWER EASEMENT

THIS GRANT OF PERMANENT EASEMENT made this 6th day of July, 1995, by THC, Inc., a Nebraska nonprofit corporation, hereinafter referred to as "GRANTOR", in favor of Lakeside Hills Association, Inc., a Nebraska nonprofit corporation, hereinafter referred to as "ASSOCIATION".

WITNESSETH:

That said GRANTOR in consideration of good and valuable consideration, the receipt whereof is hereby acknowledged, does hereby grant, sell, convey, and confirm unto ASSOCIATION and its successors and assigns forever, a nonexclusive permanent right and easement to use, construct, build, lay, maintain, repair, reconstruct, replace, relocate, improve and connect to drainage ways and storm sewers, and appurtenances thereof, in, through, over, and under the parcels of land described as follows, to wit:

As set forth on Exhibits "A" through "M", inclusive, attached hereto and made a part hereof.

To have and to hold unto ASSOCIATION, its successors and assigns, together with the right of ingress and egress from said nonexclusive easement areas herein granted for the purpose of constructing, building, laying, maintaining, repairing, reconstructing, replacing, relocating, improving, using and connecting to said sewers and appurtenances thereof at the discretion of ASSOCIATION, its successors and assigns. As consideration for ASSOCIATION's acceptance of this easement grant and the other agreements herein, GRANTOR agrees to build and construct the storm sewers and appurtenances thereof within the easement areas without any cost and expense to Association. Grantor hereby perpetually grants, conveys and assigns to ASSOCIATION the sole right, title and ownership of the storm sewers and appurtenances thereof.

Upon GRANTOR'S completion of construction and installation of the storm sewers and appurtenances thereto, GRANTOR shall have no right, obligation or responsibility whatsoever to thereafter maintain, repair, reconstruct, replace, relocate or improve said sewers and appurtenances thereof but reserves herein the right to perpetually use and connect to such storm sewers and appurtenances thereof. ASSOCIATION hereby agrees for itself, its successors and assigns that it shall have the exclusive right, obligation and responsibility to perpetually maintain, repair, reconstruct, replace, relocate and improve said sewers and appurtenances thereof and shall have the right of ingress and egress from said easement areas herein granted for the purposes granted to it herein.

GRANTOR hereby reserves for itself, its successors and assigns the right at any time to construct or install or cause to be constructed or installed upon or within the easement areas herein granted or grant other permanent and construction easements, licenses, or other rights respecting the easement areas granted herein so as to permit such roads, streets, parking areas, or other pavement or concrete improvements, fencing, entrance markers, any gas, electric, water, storm and sanitary sewer, telephone, cable, or any other type of utility lines, pipes, conduits, ducts, or systems, landscaping, and plant

7/3/95
H:\L\DOBK\THC\7-3EASE.4

10733
FEE 86.00 FB MI-21555
BKP _____ C/O _____ COMP W
DEL _____ SCAN de FV _____

materials, all in such manner and to the extent as GRANTOR or its successors and assigns may deem necessary or appropriate in its sole discretion (collectively, the "Grantor Improvements"). Any construction or installation of Grantor Improvements shall be effected so as not to at any time unreasonably interfere with the normal use and operation of the sewers to be constructed in the easement areas granted herein.

GRANTOR, its successors and assigns and ASSOCIATION, its successors and assigns, shall not construct or install, or permit the construction or installation of any buildings or other such permanent structures on, over, or across the easement areas granted herein.

GRANTOR, or its successors and assigns shall have the right at any time to relocate, at its sole cost and expense, all or any portion of the easement areas granted herein and/or the sewers and appurtenances located therein and any such relocation shall be effected so as not to unreasonably interfere with the normal use and operation of the sewers within the easement areas and, provided further, that GRANTOR or its successors and assigns shall grant or cause to be granted to ASSOCIATION, its successors and assigns, a nonexclusive permanent easement upon the same terms and conditions as contained herein over the properties in which the sewers and the easement areas granted herein are relocated.

The easements granted herein shall be for the benefit of the successors and assigns of ASSOCIATION and any contractor, agent, employee, or representative of ASSOCIATION performing any of said construction, repair, and maintenance work on the easement areas granted herein.

GRANTOR, for itself and its successors and assigns, does confirm with ASSOCIATION and its successors and assigns that GRANTOR is well seized in fee of the above-described easement areas granted herein and that it has the right to grant and convey this nonexclusive permanent easements in the manner and form aforesaid, and that GRANTOR will, and its successors and assigns shall, warrant and defend this easement grant to ASSOCIATION, its successors and assigns, against the lawful claims and demands of all persons.

These nonexclusive permanent easements shall run with the land perpetually and shall be binding upon and inure to the benefit of the GRANTOR and ASSOCIATION, and their respective successors and assigns and any person or party claiming by, through or under GRANTOR and ASSOCIATION or their respective successors or assigns.

The acceptance of and agreement to each of the terms and provisions of this document by ASSOCIATION, its successors and assigns shall be conclusively evidenced by the recording of this document with the office of the Douglas County Register of Deeds.

IN WITNESS WHEREOF, said GRANTOR has caused this Permanent Easement Agreement to be duly executed by its President the day and year first above written.

THC, INC., A Nebraska Nonprofit
Corporation

By 
Alden B. Awerkamp
Its President

STATE OF NEBRASKA)
) ss.
COUNTY OF DOUGLAS)

The foregoing instrument was acknowledged before me this 6 day of July, 1995, by Alden B. Awerkamp, President of THC, Inc., a Nebraska Nonprofit corporation, on behalf of the corporation.

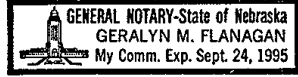

Geralyn M. Flanagan

Notary Public

LEGAL DESCRIPTION

A permanent easement for the construction and maintenance of drainage and storm sewers over that part of Lot 2, LAKESIDE HILLS, a subdivision, as surveyed, platted and recorded in Douglas County, Nebraska, described as follows:

Commencing at the west end of the tangent on the north line of said Lot 2; Thence along a curve to the left (having a radius of 328.50 feet and a long chord bearing North 81°04'52" West (bearings referenced to the LAKESIDE HILLS Final Plat) for 11.24 feet) for an arc length of 11.24 feet along the north line of said Lot 2 to the TRUE POINT OF BEGINNING;

Thence along a curve to the left (having a radius of 328.50 feet and a long chord bearing South 68°39'14" West for 321.37 feet) for an arc length of 335.81 feet along the north line of said Lot 2;

Thence North 51°31'50" East for 138.41 feet to the north line of said Lot 2;

Thence along a curve to the right (having a radius of 328.50 feet and a long chord bearing North 65°54'52" East for 25.47 feet) for an arc length of 25.48 feet along the north line of said Lot 2;

Thence North 83°02'16" East for 168.95 feet to the Point of Beginning.

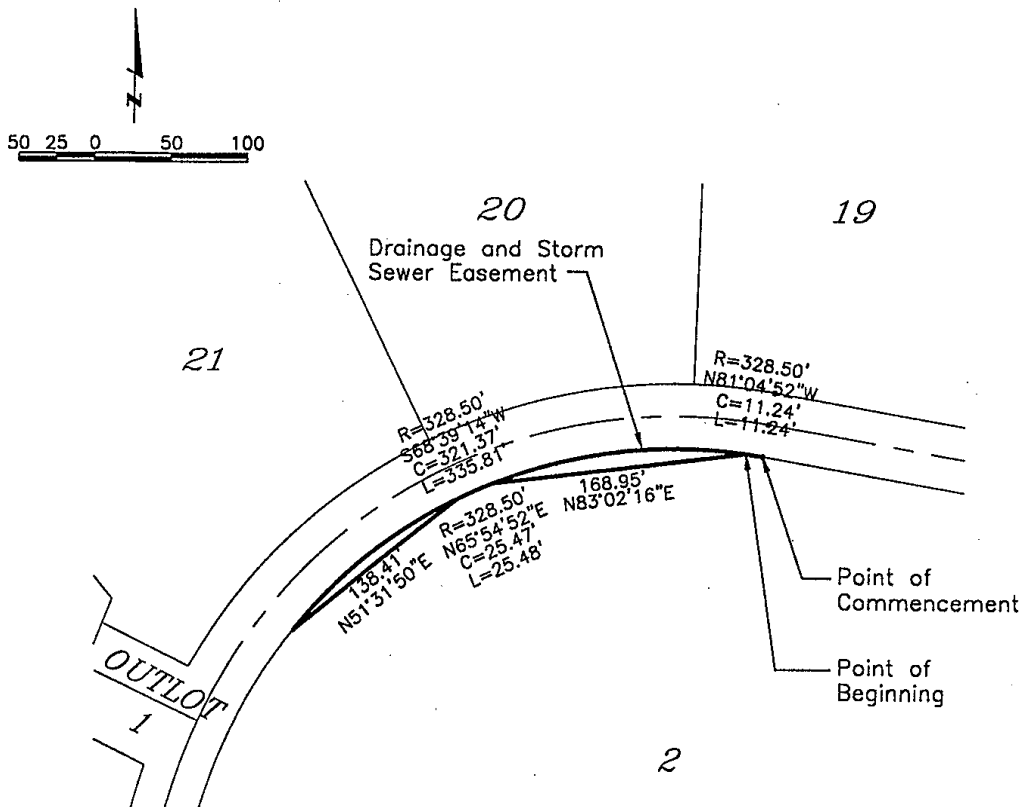

Book _____ Page _____ Date 5/16/95 Job Number 89014-6583

	lamp, rynearson & associates, inc. <small>engineers surveyors planners</small>	
14747 california street	omaha, nebraska 68154-1979	402-496-2498 FAX 402-496-2700

LEGAL DESCRIPTION

A permanent easement for the construction and maintenance of drainage and storm sewers over that part of Lot 5, LAKESIDE HILLS, a subdivision, as surveyed, platted and recorded in Douglas County, Nebraska, described as follows:

Beginning at the southeast corner of said Lot 5;
 Thence South $80^{\circ}08'03''$ West (bearings referenced to the LAKESIDE HILLS Final Plat) for 32.48 feet along the south line of said Lot 5;
 Thence along a curve to the left (having a radius of 896.14 feet and a long chord bearing South $70^{\circ}34'38''$ West for 297.57 feet) for an arc length of 298.95 feet along the south line of said Lot 5;
 Thence North $82^{\circ}01'04''$ West for 52.50 feet along the south line of said Lot 5 to the east right of way line of 171st Street;
 Thence North $40^{\circ}46'21''$ West for 14.06 feet along the west line of said Lot 5;
 Thence North $88^{\circ}14'05''$ East for 88.93 feet;
 Thence North $65^{\circ}54'46''$ East for 142.88 feet;
 Thence North $75^{\circ}47'30''$ East for 151.65 feet;
 Thence along a curve to the right (having a radius of 178.50 feet and a long chord bearing South $25^{\circ}29'22''$ East for 13.58 feet) for an arc length of 13.58 feet to the Point of Beginning.

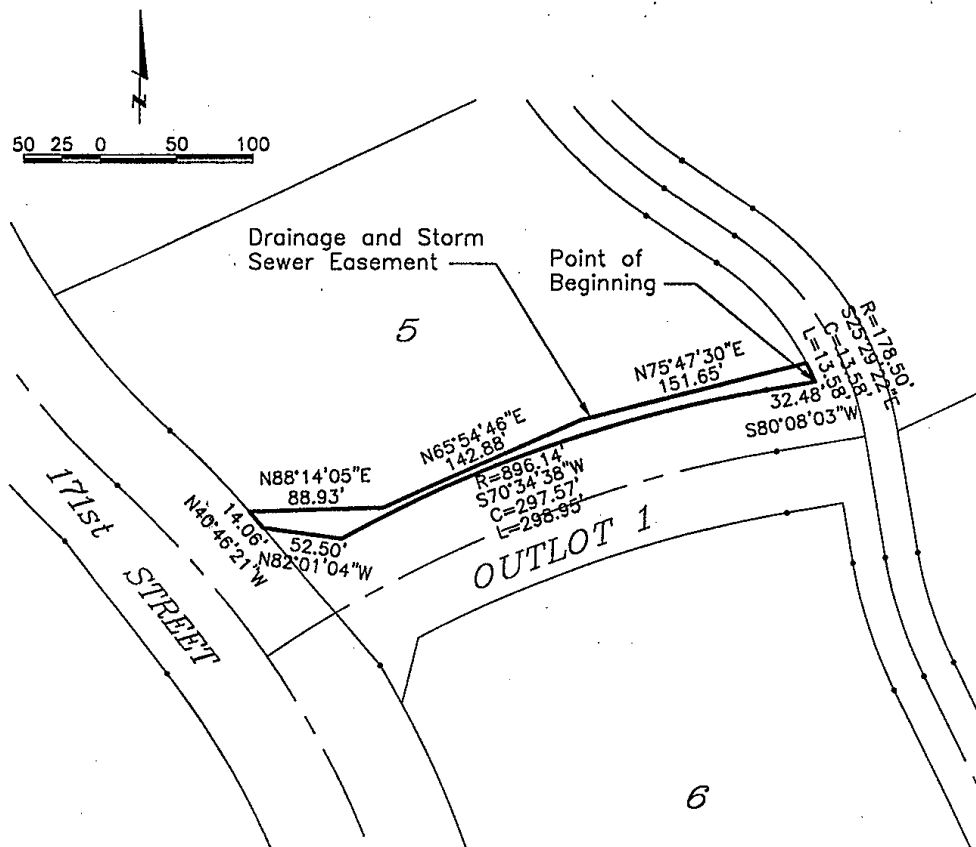

Book _____

Page _____

Date

5/16/95

Job Number

89014-6583



lamp, rynearson & associates, inc.
 engineers surveyors planners

14747 california street

omaha, nebraska 68154-1979

402-496-2498
FAX 402-496-2730

LEGAL DESCRIPTION

A permanent easement for the construction and maintenance of drainage and storm sewers over that part of Lot 6, LAKESIDE HILLS, a subdivision, as surveyed, platted and recorded in Douglas County, Nebraska, described as follows:

- Beginning at the northeast corner of said Lot 6;
- Thence South 09°51'57" East (bearings referenced to the LAKESIDE HILLS Final Plat) for 40.37 feet along the east line of said Lot 6;
- Thence along a curve to the left (having a radius of 321.50 feet and a long chord bearing South 17°50'26" East for 89.21 feet) for an arc length of 89.50 feet along the east line of said Lot 6;
- Thence South 25°48'55" East for 151.50 feet along the east line of said lot 6 to the southeast corner thereof;
- Thence South 64°11'05" West for 9.92 feet along the south line of said Lot 6;
- Thence North 25°48'55" West for 150.00 feet;
- Thence North 21°02'54" West for 116.67 feet;
- Thence North 13°56'10" West for 52.36 feet to the north line of said Lot 6;
- Thence North 80°08'03" East for 13.36 feet to the Point of Beginning.

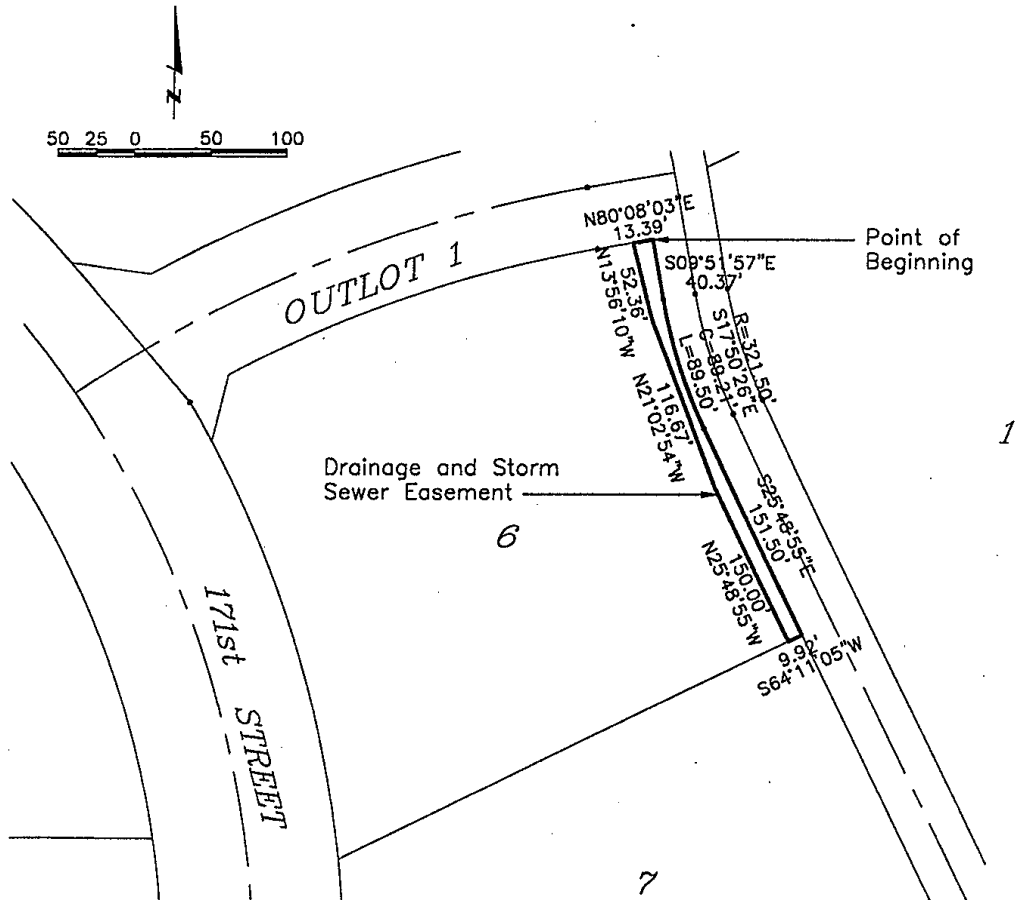

Book _____ Page _____ Date 5/16/95 Job Number 89014-6583

lamp, ryneason & associates, inc.
 engineers surveyors planners
 14747 california street omaha, nebraska 68154-1979 402-498-2498
 FAX 402-498-2730

LEGAL DESCRIPTION

A permanent easement for the construction and maintenance of drainage and storm sewers over that part of Lot 7, LAKESIDE HILLS, a subdivision, as surveyed, platted and recorded in Douglas County, Nebraska, described as follows:
 Beginning at the northeast corner of said Lot 7;
 Thence South 25°48'55" East (bearings referenced to the LAKESIDE HILLS Final Plat) for 211.20 feet along the east line of said Lot 7;
 Thence along a curve to the left (having a radius of 271.50 feet and a long chord bearing South 28°33'25" East for 25.97 feet) for an arc length of 25.98 feet along the east line of said Lot 7 to the southeast corner thereof;
 Thence South 58°42'05" West for 5.78 feet along the south line of said Lot 7;
 Thence North 52°14'02" West for 11.33 feet;
 Thence North 25°54'25" West for 227.55 feet to the north line of said Lot 7;
 Thence North 64°11'05" East for 9.92 feet to the Point of Beginning.

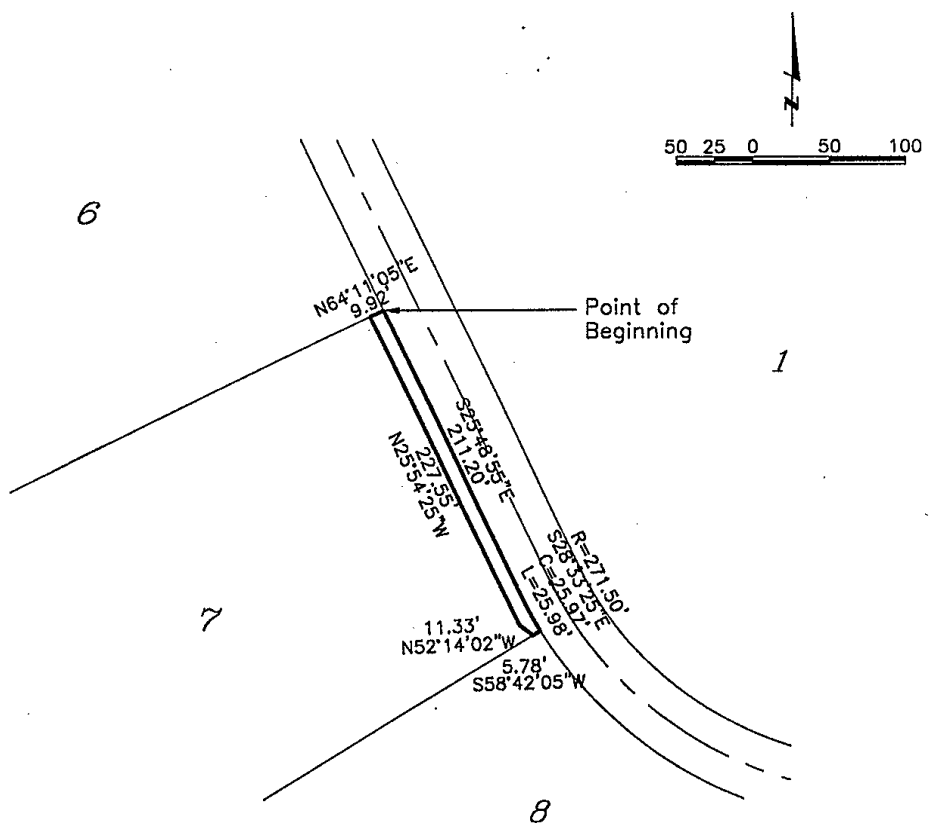

Book _____ Page _____ Date 5/16/95 Job Number 89014-6583

	lamp, ryneason & associates, inc.		
	engineers	surveyors	planners
14747 california street		omaha, nebraska 68154-1979	402-496-2498 FAX 402-496-2730

LEGAL DESCRIPTION

A permanent easement for the construction and maintenance of drainage and storm sewers over that part of Lot 8, LAKESIDE HILLS, a subdivision, as surveyed, platted and recorded in Douglas County, Nebraska, described as follows:

Beginning at the northwest corner of said Lot 8;

Thence along a curve to the left (having a radius of 271.50 feet and a long chord bearing South 33°01'52" East (bearings referenced to the LAKESIDE HILLS Final Plat) for 16.42 feet) for an arc length of 16.42 feet along the north line of said Lot 9;

Thence North 52°14'02" West for 17.57 feet to the west line of said Lot 8;

Thence North 58°42'05" East for 5.78 feet to the Point of Beginning.

TOGETHER WITH

A permanent easement for the construction and maintenance of drainage and storm sewers over that part of Lot 8, LAKESIDE HILLS, a subdivision, as surveyed, platted and recorded in Douglas County, Nebraska, described as follows:

Beginning at the northeast corner of said Lot 8;

Thence South 18°40'31" West (bearings referenced to the LAKESIDE HILLS Final Plat) for 2.55 feet along the east line of said Lot 8;

Thence North 52°14'02" West for 8.13 feet to the north line of said Lot 8;

Thence along a curve to the left (having a radius of 271.50 feet and a long chord bearing South 70°30'52" East for 7.68 feet) for an arc length of 7.68 feet to the Point of Beginning.

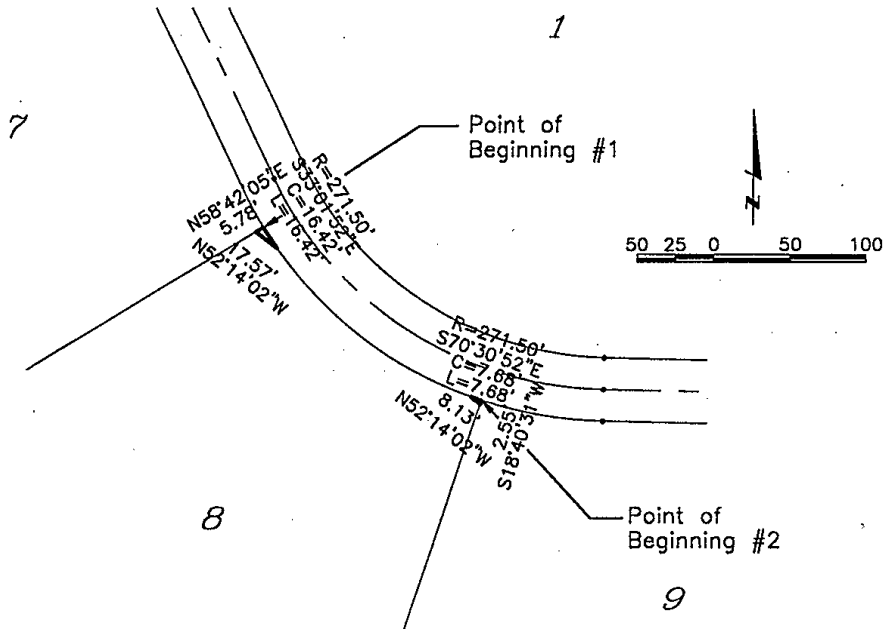

Book _____ Page _____ Date 5/16/95 Job Number 89014-6583

lamp, ryneason & associates, inc.
 engineers surveyors planners
 14747 california street omaha, nebraska 68154-1979 402-496-2498
 FAX 402-496-2790

LEGAL DESCRIPTION

A permanent easement for the construction and maintenance of drainage and storm sewers over that part of Lot 9, LAKESIDE HILLS, a subdivision, as surveyed, platted and recorded in Douglas County, Nebraska, described as follows:

Beginning at the northwest corner of said Lot 9;

Thence along a curve to the left (having a radius of 271.50 feet and a long chord bearing South 75°01'08" East (bearings referenced to the LAKESIDE HILLS Final Plat) for 34.99 feet) for an arc length of 35.01 feet along the north line of said Lot 9;

Thence South 65°38'47" West for 18.05 feet;

Thence North 52°14'02" West for 22.98 feet to the west line of said Lot 9;

Thence North 18°40'31" East for 2.55 feet to the Point of Beginning.

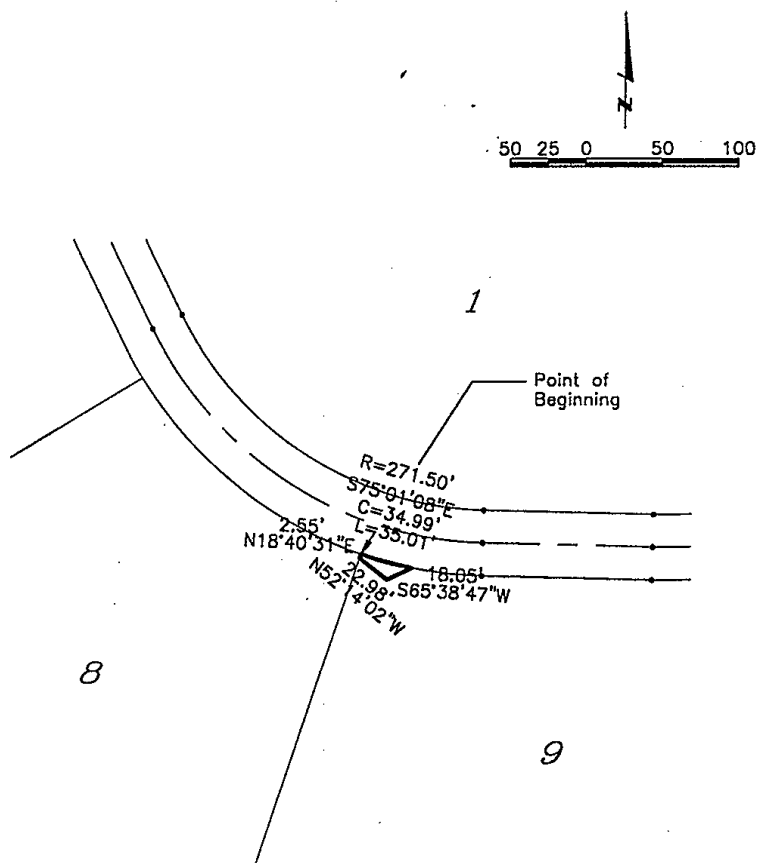

Book _____ Page _____ Date 5/16/95 Job Number 89014-6583



lamp, rynearson & associates, inc.

engineers

surveyors

planners

14747 california street

omaha, nebraska 68154-1979

402-496-2498
FAX 402-496-2730

LEGAL DESCRIPTION

A permanent easement for the construction and maintenance of drainage and storm sewers over the North 14.37 feet of the West ten feet (10') of Lot 11, LAKESIDE HILLS, a subdivision, as surveyed, platted and recorded in Douglas County, Nebraska.

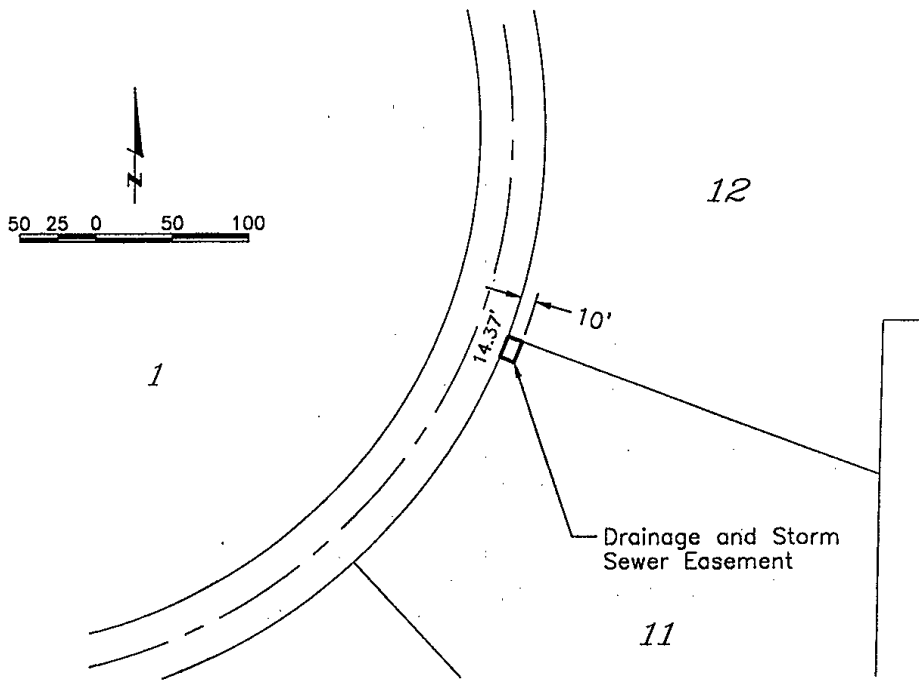

Book _____ Page _____

Date 5/16/95

Job Number 89014-6583

	lamp, rynearson & associates, inc.		
	engineers	surveyors	
14747 california street	omaha, nebraska 68154-1979	402-496-2498 FAX 402-496-2730	

LEGAL DESCRIPTION

A permanent easement for the construction and maintenance of drainage and storm sewers over the West ten feet (10') of Lot 12, LAKESIDE HILLS, a subdivision, as surveyed, platted and recorded in Douglas County, Nebraska.

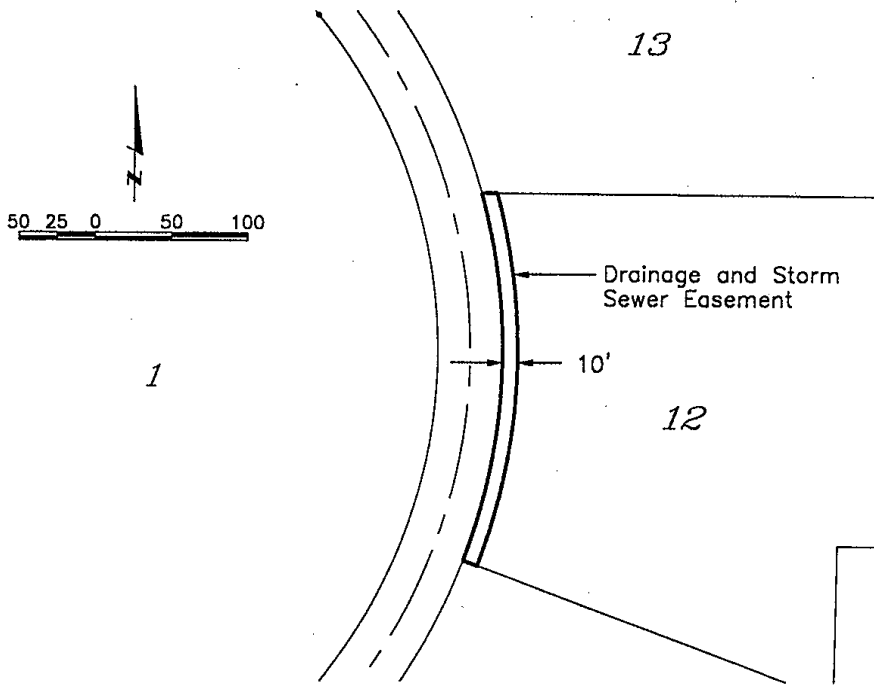

Book _____ Page _____ Date 5/16/95 Job Number 89014-6583

	lamp, rynearson & associates, inc.	
	<small>engineers surveyors planners</small>	
14747 california street	omaha, nebraska 68154-1979	402-496-2498 FAX 402-496-2730

LEGAL DESCRIPTION

A permanent easement for the construction and maintenance of drainage and storm sewers over that part of Lot 13, LAKESIDE HILLS, a subdivision, as surveyed, platted and recorded in Douglas County, Nebraska, described as follows:
 Beginning at the northwest corner of said Lot 13;
 Thence South 89°44'27" East (bearings referenced to the LAKESIDE HILLS Final Plat) for 17.04 feet along the north line of said Lot 13;
 Thence South 30°48'50" East for 18.59 feet;
 Thence South 40°04'35" East for 45.62 feet;
 Thence along a curve to the right (having a radius of 396.50 feet and a long chord bearing South 27°46'05" East for 169.13 feet) for an arc length of 170.44 feet to the south line of said Lot 13;
 Thence North 89°44'27" West for 10.40 feet to the southwest corner of said Lot 13;
 Thence along a curve to the left (having a radius of 386.50 feet and a long chord bearing North 27°58'37" West for 162.12 feet) for an arc length of 163.33 feet along the west line of Lot 13;
 Thence North 40°04'35" West for 75.01 feet to the Point of Beginning.

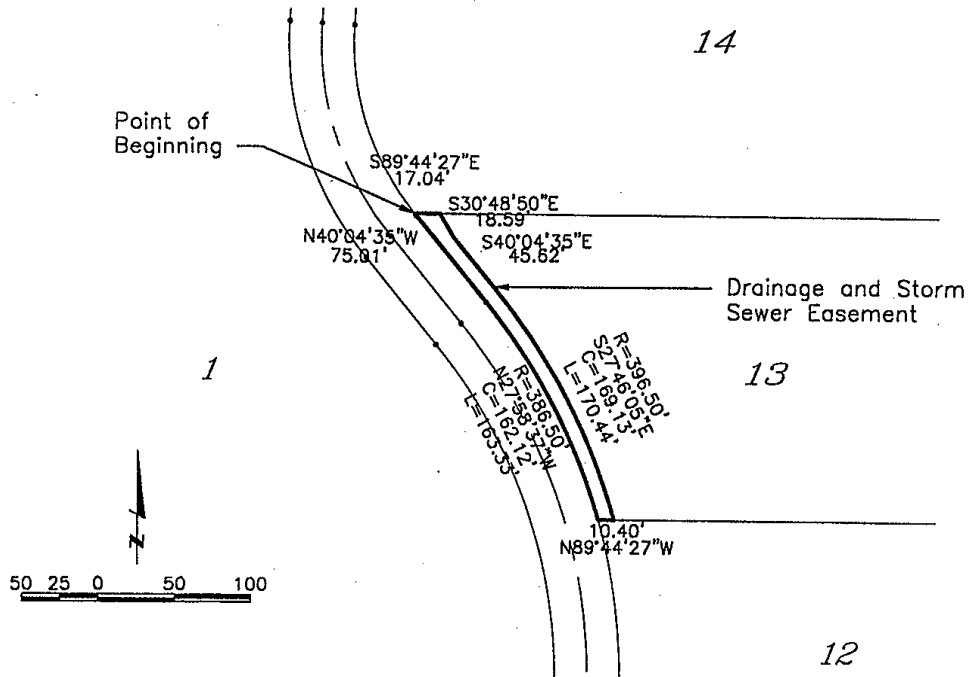

Book _____ Page _____ Date 5/16/95 Job Number 89014-6583



lamp, rynearson & associates, inc.
 engineers surveyors planners
 14747 california street omaha, nebraska 68154-1979 402-496-2498
 FAX 402-496-2730

LEGAL DESCRIPTION

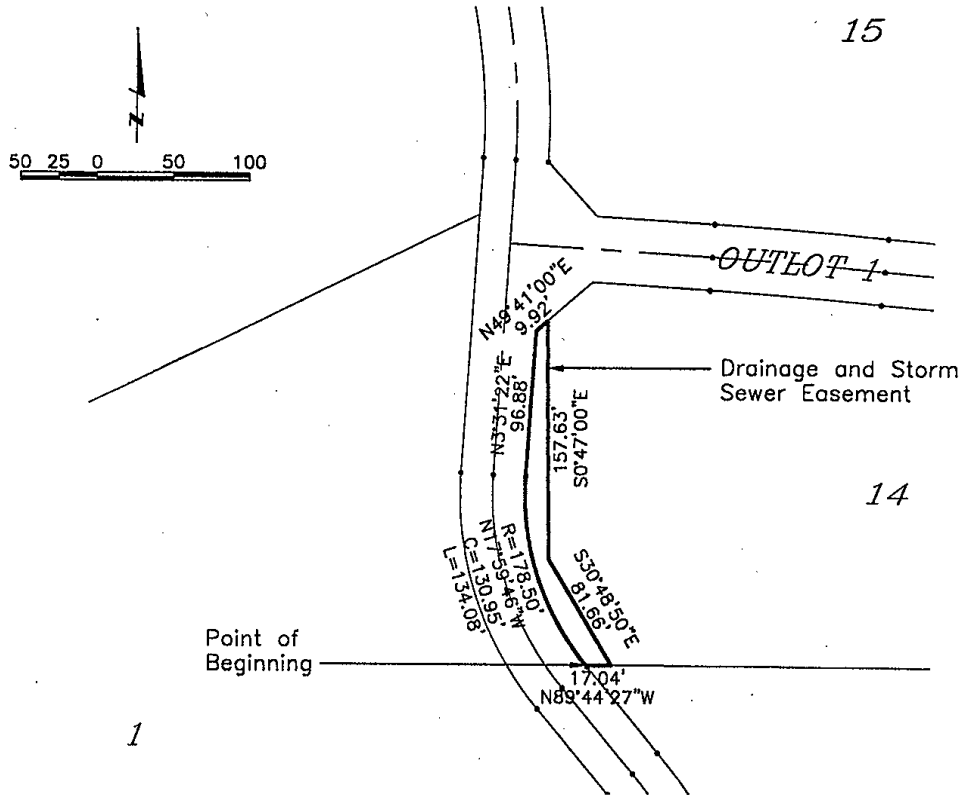
A permanent easement for the construction and maintenance of drainage and storm sewers over that part of Lot 14, LAKESIDE HILLS, a subdivision, as surveyed, platted and recorded in Douglas County, Nebraska, described as follows:
 Beginning at the southwest corner of said Lot 14;
 Thence along a curve to the right (having a radius of 178.50 feet and a long chord bearing North 17°59'46" West (bearings referenced to the LAKESIDE HILLS Final Plat) for 130.95 feet) for an arc length of 134.08 feet along the west line of said Lot 14;
 Thence North 03°31'22" East for 96.88 feet along the west line of said Lot 14;
 Thence North 49°41'00" East for 9.92 feet along the northwest line of said Lot 14;
 Thence South 00°47'00" East for 157.63 feet;
 Thence South 30°48'50" East for 81.66 feet to the south line of said Lot 14;
 Thence North 89°44'27" West for 17.04 feet to the Point of Beginning.



Book _____ Page _____ Date 5/16/95 Job Number 89014-6583

lamp, rynearson & associates, inc.
 engineers surveyors planners
 14747 california street omaha, nebraska 68154-1979 402-496-2498
 FAX 402-496-2730

LEGAL DESCRIPTION

A permanent easement for the construction and maintenance of drainage and storm sewers over that part of Lot 15, LAKESIDE HILLS, a subdivision, as surveyed, platted and recorded in Douglas County, Nebraska, described as follows:

Beginning at the southwest corner of said Lot 15;
Thence North 42°38'18" West (bearings referenced to the LAKESIDE HILLS Final Plat) for 41.42 feet along the southwest line of said Lot 15;
Thence South 64°38'36" East for 52.07 feet;
Thence South 86°03'08" East for 135.68 feet;
Thence South 04°43'32" West for 9.24 feet to the south line of said Lot 15;
Thence along a curve to the left (having a radius of 3153.55 feet and a long chord bearing North 85°47'06" West for 76.19 feet) for an arc length of 76.20 feet along the south line of said Lot 15;
Thence North 86°28'38" West for 77.76 feet to the Point of Beginning.

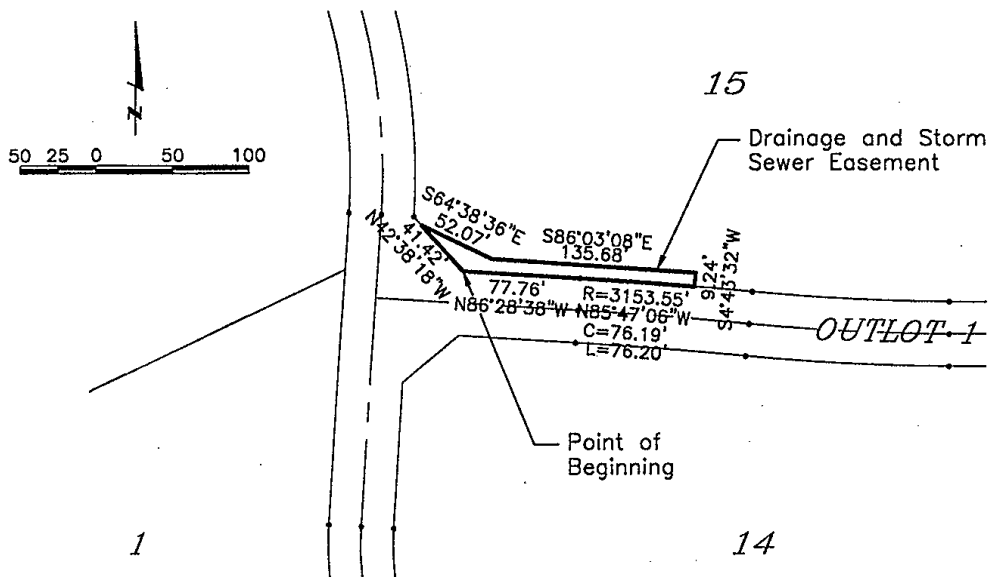

Book _____ Page _____ Date 5/16/95 Job Number 89014-6583

	lamp, rynearson & associates, inc.			
	engineers	surveyors	planners	
	14747 california street	omaha, nebraska 68154-1979	402-496-2498 FAX 402-496-2730	

LEGAL DESCRIPTION

A permanent easement for the construction and maintenance of drainage and storm sewers over that part of Lot 18, LAKESIDE HILLS, a subdivision, as surveyed, platted and recorded in Douglas County, Nebraska, described as follows:

Beginning at the southeast corner of said Lot 18;

Thence along a curve to the left (having a radius of 446.50 feet and a long chord bearing North 76°30'05" West (bearings referenced to the LAKESIDE HILLS Final Plat) for 56.07 feet) for an arc length of 56.10 feet along the south line of said Lot 18;

Thence North 80°06'03" West for 138.55 feet along the south line of said Lot 18;

Thence South 81°48'52" East for 190.51 feet;

Thence South 66°10'04" East for 13.71 feet to the east line of said Lot 18;

Thence South 67°13'44" West for 10.96 feet to the Point of Beginning.

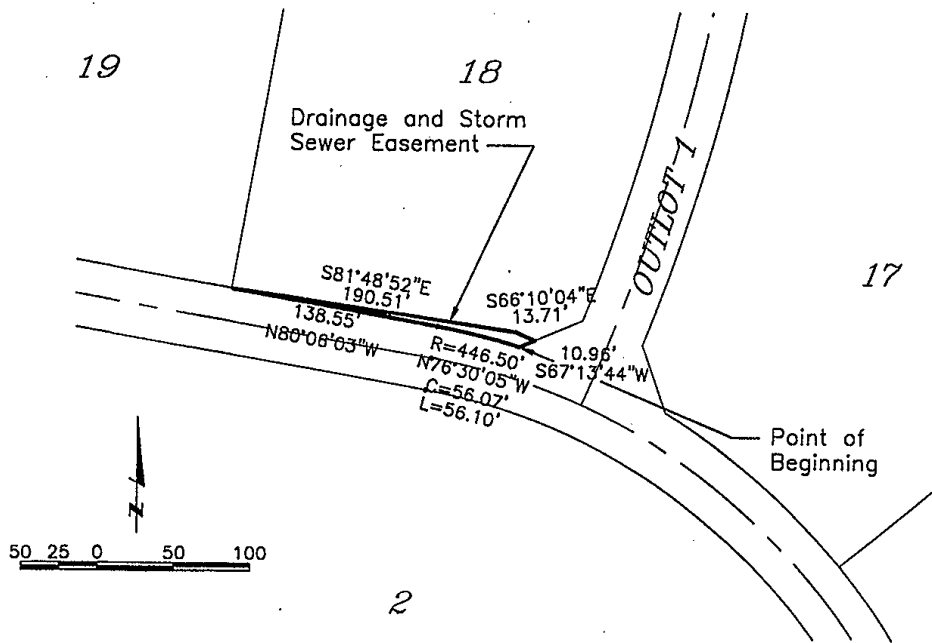

Book _____ Page _____ Date 5/16/95 Job Number 89014-6583

lamp, rynearson & associates, inc.
 engineers surveyors planners
 14747 california street omaha, nebraska 68154-1979 402-496-2498
 FAX 402-496-2730

LEGAL DESCRIPTION

A permanent easement for the construction and maintenance of drainage and storm sewers over that part of Lot 21, LAKESIDE HILLS, a subdivision, as surveyed, platted and recorded in Douglas County, Nebraska, described as follows:

Beginning at the southeast corner of said Lot 21;

Thence North 63°59'03" West (bearings referenced to the LAKESIDE HILLS Final Plat) for 62.90 feet along the south line of said Lot 21 to the west line of said Lot 21;

Thence North 21°53'02" East for 13.99 feet along the west line of said Lot 21;

Thence South 64°36'45" East for 58.66 feet;

Thence North 51°31'50" East for 20.89 feet to the east line of said Lot 21;

Thence along a curve to the left (having a radius of 371.50 feet and a long chord bearing South 32°23'39" West for 33.65 feet) for an arc length of 33.67 feet to the Point of Beginning.

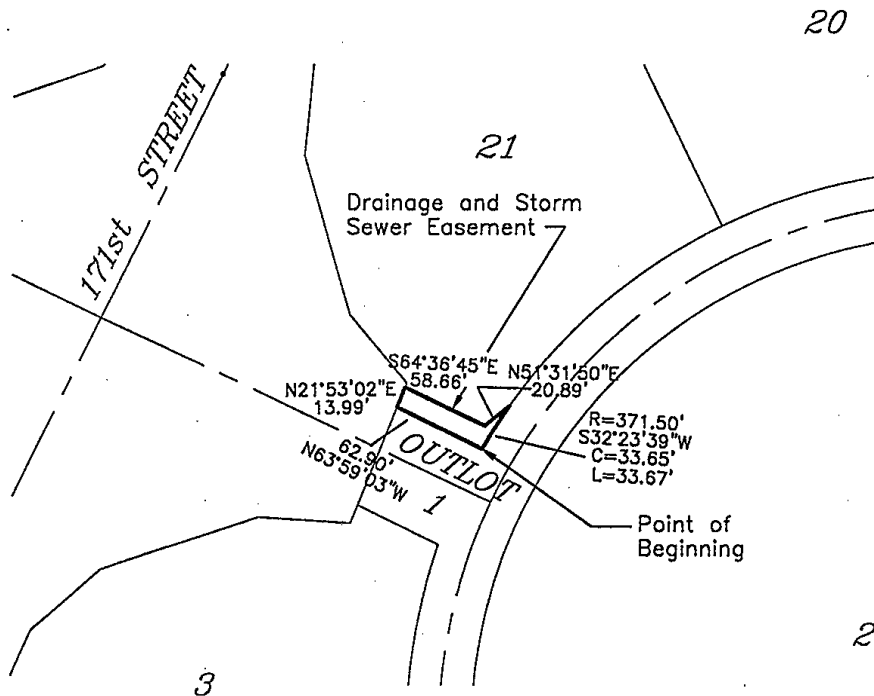
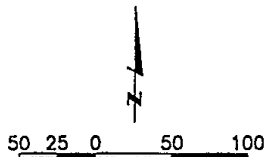

Book _____ Page _____ Date 5/16/95 Job Number 89014-6583

	lamp, ryneason & associates, inc.		
	engineers	surveyors	planners
	14747 california street	omaha, nebraska 68154-1979	402-496-2498 FAX 402-496-2730