**MASTER DEED AND DECLARATION OF
CONDOMINIUM OWNERSHIP FOR
ANTLER VIEW OFFICE CONDOMINIUMS**

**PREPARED BY, RECORDING REQUESTED BY,
AND WHEN RECORDED MAIL TO:**

**Fullenkamp, Jobeun, Johnson & Beller LLP
11440 West Center Road, Suite C
Omaha, NE 68144
Attention: Mark B. Johnson**

TABLE OF CONTENTS

	Page
ARTICLE I	
SUBMISSION OF PROPERTY	
ARTICLE II	
DEFINITIONS	
Section 2.1	General2
Section 2.2	Other Terms Defined in Act.....5
Section 2.3	Other Terms in Declaration5
ARTICLE III	
CONDOMINIUM INFORMATION	
Section 3.1	Name5
Section 3.2	Association5
Section 3.3	County5
Section 3.4	Legal Description5
Section 3.5	Number of Units5
Section 3.6	Boundaries and Description of Condominium Unit5
Section 3.7	Limited Common Elements7
Section 3.8	Development Rights and Special Declarant Rights7
Section 3.9	Recording Data7
Section 3.10	Notices.....7
Section 3.11	Use of Units7
Section 3.12	Residential Use Prohibited7
Section 3.13	Use of Units Owned by Declarant8
Section 3.14	Easement Rights.....8
ARTICLE IV	
MEMBERSHIP, VOTING RIGHTS AND ALLOCATIONS	
Section 4.1	Membership8
Section 4.2	Voting Rights and Assignment of Votes9
Section 4.3	Allocated Interests9
Section 4.4	Deadlock Resolution9
ARTICLE V	
ASSOCIATION AND EXECUTIVE BOARD	
Section 5.1	Authority and Power.....10
Section 5.2	Membership10
Section 5.3	Executive Board Powers and Duties10

TABLE OF CONTENTS
(continued)

		Page
Section 5.4	Professional Management and Contract Termination Provisions	12
Section 5.5	Executive Board Limitations	12
Section 5.6	Executive Board Standard of Care	12
ARTICLE VI		
COMMON ELEMENTS		
Section 6.1	Dedication of Common Elements	12
Section 6.2	Description of Common Elements	12
Section 6.3	Maintenance, Repair and Replacements of Common Elements	13
Section 6.4	Common Utilities	13
Section 6.5	Unit Owner's Easements of Enjoyment	13
Section 6.6	Delegation of Use	14
Section 6.7	No Partition of Common Elements	14
Section 6.8	No Severance of Ownership	14
ARTICLE VII		
LIMITED COMMON ELEMENTS		
Section 7.1	Limited Common Elements	14
Section 7.2	Use of Limited Common Elements	15
Section 7.3	Allocation of Specified Common Elements	15
Section 7.4	Expense Allocation	15
Section 7.5	Maintenance, Repair and Replacements of Limited Common Elements	15
Section 7.6	Mechanics' Liens and Materialmen's Liens	16
Section 7.7	Monument Sign	16
 ARTICLE VIII		
ASSESSMENTS		
Section 8.1	Covenant for Assessments	17
Section 8.2	Working Capital Fund	17
Section 8.3	Purpose and Use of Assessments	17
Section 8.4	Annual Common Expense Assessments	18
Section 8.5	Budget	18
Section 8.6	Special Assessments	19
Section 8.7	Notice and Quorum	19

TABLE OF CONTENTS
(continued)

	Page
Section 8.8 Rate of Assessment.....	19
Section 8.9 Payment of Assessments.....	19
Section 8.10 Date of Commencement: Annual Common Expense Assessments	19
ARTICLE IX	
ASSOCIATION'S LIEN	
Section 9.1 Association Lien and Effect of Non-Payment of Assessments.....	20
Section 9.2 Priority of Liens	21
Section 9.3 Certificate of Status of Assessments or other Defaults.....	21
Section 9.4 Exempt Property	21
Section 9.5 Common Expenses Attributable to Fewer than All Units	22
Section 9.6 Unit Owner's Negligence and Individual Assessments.....	22
ARTICLE X	
INSURANCE	
Section 10.1 Insurance Requirements Generally.....	22
Section 10.2 Unit Owner's Insurance.....	23
ARTICLE XI	
INDEMNIFICATION	
ARTICLE XII	
ARCHITECTURAL CONTROL	
Section 12.1 Architectural Control Committee	24
Section 12.2 Control	24
Section 12.3 Purpose	24
Section 12.4 Review of Plans and Specifications.....	25
Section 12.5 Submission	25
Section 12.6 Rules and Guidelines	25
Section 12.7 No Waiver of Future Approval	25
Section 12.8 Variances.....	25
ARTICLE XIII	
RESTRICTIVE COVENANTS AND OBLIGATIONS	
Section 13.1 No Improvements on Exterior of Unit	26
Section 13.2 Noxious or Offensive Trades Prohibited	26
Section 13.3 Temporary Modular and Storage Structures	26
Section 13.4 Additional Prohibitions.....	26
Section 13.5 Utilities	26

TABLE OF CONTENTS
(continued)

		Page
Section 13.6	Intentionally Deleted	26
Section 13.7	Storage of Vehicles	26
Section 13.8	Maintenance of Units and Improvements	26
Section 13.9	Animals	26
Section 13.10	Nuisance	26
Section 13.11	Damage or Destruction of Improvements	27
Section 13.12	Signs	27
Section 13.13	Color	27
Section 13.14	Nighttime Lighting	27
Section 13.15	Further Subdivision	27
Section 13.16	Discharge of Weapons	27
Section 13.17	Disturbing the Peace	27
Section 13.18	Drainage	27
Section 13.19	Parking	27
Section 13.20	General Prohibition	27
ARTICLE XIV		
DAMAGE, DESTRUCTION, CONDEMNATION AND RESTORATION OF BUILDINGS		
Section 14.1	Sufficient Insurance	28
Section 14.2	Insufficient Insurance	28
Section 14.3	Eminent Domain	29
Section 14.4	Repair, Restoration or Reconstruction of the Improvements	29
ARTICLE XV		
REMEDIES		
Section 15.1	Violations	30
Section 15.2	Remedies	30
Section 15.3	Enforcement by Unit Owners	32
ARTICLE XVI		
GENERAL PROVISIONS		
Section 16.1	Certain Rights of the Declarant	32
Section 16.2	Employees: Maintenance of Common Elements	33
Section 16.3	Record of Receipts and Expenditures	33
Section 16.4	Conveyance and Leases	33
Section 16.5	Term of Declaration	33

TABLE OF CONTENTS
(continued)

	Page
Section 16.6	Amendment of Declaration..... 34
Section 16.7	Special Amendment..... 34
Section 16.8	Assignments by Declarant..... 34
Section 16.9	Unit Owner's Duty to Disclose 34
Section 16.10	Association Right to Security Interest Information 35
Section 16.11	Taxes..... 35
Section 16.12	Captions..... 35
Section 16.13	Waiver 35
Section 16.14	Invalidity and Severability..... 35
Section 16.15	Conflict..... 35
Section 16.16	Meetings 35
Section 16.17	Controlling Law Jurisdiction and Venue 35

EXHIBIT "A" – LEGAL DESCRIPTION

EXHIBIT "B" – PLATS AND PLANS

EXHIBIT "C" – UNIT OWNERSHIP AND PERCENTAGE INTERESTS TABLE

**MASTER DEED AND DECLARATION OF
CONDOMINIUM OWNERSHIP FOR
ANTLER VIEW OFFICE CONDOMINIUMS**

THIS MASTER DEED AND DECLARATION OF CONDOMINIUM OWNERSHIP FOR ANTLER VIEW OFFICE CONDOMINIUMS (this "Declaration") is made and entered into this 5th day of November, 2019, by FTF Investments, LLC, a Nebraska limited liability company ("Declarant").

RECITALS

A. Declarant is the owner of certain real property located in the County of Douglas, State of Nebraska, which is more particularly described on Exhibit "A" attached hereto (the "Property" or "Phase 1 Property").

B. Declarant desires and intends by this Declaration to submit the Property to the provisions of the Nebraska Condominium Act, Neb. Rev. Stat. § 76-825, et seq., as amended from time to time (the "Act"), as a condominium, as defined in the Act, pursuant to which portions of the Property will be designated for separate ownership and the remainder of which will be for common ownership solely by the Unit Owners of the separate ownership interests.

C. In addition to the formation of this Condominium (defined below), to be comprised of the Property aforementioned, Declarant, hereby further reserves unto itself and its successors and assigns acting as Declarant, Special Declarant Rights, as defined in the Act, to include by way of example and not limitation, the right to exercise Development Rights, as defined in the Act, including the right and option, but not the obligation, in its own discretion and by its own act, to (i) relocate the boundaries of any Unit or Units, (ii) further subdivide any one or more of the Units into additional Units, Common Elements or Limited Common Elements, and (iii) to add real estate to the Condominium such as to include all or any portion of the Additional Property (as defined in Section 2.1, below), all as further provided in this Declaration and pursuant to the terms of the Act. This Declaration shall not apply to or otherwise encumber any or all of the Additional Property until such time as this option and right of Declarant is exercised pursuant to the terms of this Declaration.

D. Declarant has organized Antler View Office Owners Association, Inc., a Nebraska nonprofit corporation, for the purpose of exercising the functions of an Association organized under Neb. Rev. Stat. §76-859.

**ARTICLE I
SUBMISSION OF PROPERTY**

Declarant hereby publishes and declares that the Property shall be held, sold, conveyed, transferred, leased, subleased and occupied subject to the following easements, covenants, conditions, and restrictions which are for the purpose of protecting the value and desirability of the Property, and which shall run with the Property and shall be binding upon and inure to the benefit of all parties having any right, title, or interest in the Property, or any portion thereof, their heirs, personal representatives, successors, and assigns. Additionally, Declarant hereby submits the Property to the provisions of the Act. To the extent this Declaration is silent on a matter covered by the Act, the provisions of the Act shall apply. If the Act is repealed, the Act

as it was in effect on the effective date of such repeal shall remain applicable. To the extent this Declaration and the Act conflict, this Declaration shall govern.

ARTICLE II DEFINITIONS

Section 2.1 General. For the purposes of brevity and clarity, certain words and terms used in this Declaration are defined as follows:

(a) “Additional Property” means Lot 2, Antler View Replat 2, a Subdivision as surveyed, platted and recorded in Douglas County, Nebraska (Phase 2), Lot 3, Antler View Replat 2, a Subdivision as surveyed, platted and recorded in Douglas County, Nebraska (Phase 3), and Lot 4, Antler View Replat 2, a Subdivision as surveyed, platted and recorded in Douglas County, Nebraska (Phase 4) as shown on the Plats and Plans, which may be added to the Condominium Property Regime in accordance with the provisions of Article III of this Declaration and the exercise of Special Declarant Rights inclusive of Development Rights reserved by Declarant to add the real estate to the Condominium Regime. The Additional Property may be referred to on the Plats and Plans as the Reserved Property (Phase 2, Phase 3, and Phase 4).

(b) “*Allocated Interests*” means the undivided interest in the Common Elements, the Common Expense Liability and votes in the Association allocated to each Unit.

(c) “*Assessments*” means all Common Expense Assessments, Special Assessments, Individual Assessments and fines levied by the Executive Board pursuant to the Declaration and Association Bylaws.

(d) “*Association*” means Antler View Office Owners Association, Inc., a Nebraska nonprofit corporation, its successors and assigns, organized and existing under §76-859 of the Act.

(e) “*Building*” or “*Buildings*” means the building or buildings located on the Property and containing the Units, as shown by the Plat and Plans depicting the respective floors of such building, and all future buildings constructed on the Property and/or Additional Property in the future.

(f) “*Bylaws*” means the Bylaws of the Association, and all amendments thereto.

(g) “*Capital Improvements*” means the construction, erection or installation of substantial structure(s) or other substantial improvement(s) in the Condominium.

(h) “*Common Elements*” means all portions of the Property except the Units, as more specifically described in Article VI hereof.

(i) “*Common Expense Liability*” means the liability for Common Expenses allocated to each Unit pursuant to Section 4.3 of this Declaration and §76-844 of the Act.

(j) “*Common Expenses*” means expenditures made or financial liabilities incurred by or on behalf of the Association, together with any allocations to reserves. These expenses for the operation of the Condominium include, but are not limited to:

(i) Expenses of administering, managing, maintaining, leasing, insuring, repairing or replacing the Common Elements;

(ii) Expenses declared to be Common Expenses by this Declaration;

(iii) Expenses agreed upon as Common Expenses by the Association;
and

(iv) Such reasonable reserves as may be established by the Association, whether held in trust or by the Association, for repair, replacement or addition to the Common Elements or any other real or personal property acquired or held by the Association.

(k) “*Condominium, Condominium Regime or Condominium Project*” means the Phase 1 Property described in Exhibit “A” attached hereto and incorporated herein by this reference, portions of which are designated for separate ownership and the remainder of which is designated for common ownership solely by the owners of those portions.

(l) “*Declarant*” means FTF Investments, LLC, a Nebraska limited liability company, and its successors and assigns.

(m) “*Declaration*” means this Master Deed and Declaration of Condominium Ownership for Antler View Office Condominiums, as recorded in the office of the Register of Deeds of Douglas County, Nebraska, together with any other recorded amendments and supplements to the Declaration from time to time.

(n) “*Executive Board*” means the body, regardless of name, designated in the Declaration to act on behalf of the Association.

(o) “*Identifying Number*” means a symbol or address that identifies only one Unit in the Condominium.

(p) “*Individual Assessments*” means any Assessments made against a Unit or Unit Owner by the Association, other than Common Expense Assessments or Special Assessments.

(q) “*Limited Common Elements*” means a portion of the Common Elements allocated in Article III, Paragraph 7 hereinafter, or by operation of subsection (2) or (4) of §76-839 of the Act for the exclusive use of one or more Units but fewer than all of the Units.

(r) “*Manager*” means a Person employed or engaged to perform management services for the Condominium and the Association.

(s) “*Member*” means every Person who is a Unit Owner.

(t) “*Person*” means a natural person, corporation, business trust, estate, trust, limited liability company, limited partnership, general partnership, association, joint venture, government, government subdivision or agency, or other legal, or commercial entity, or any combination thereof.

(u) “*Plat and Plans*” means the Plat and Plans prepared in accordance with §76-846 of the Act and attached hereto as Exhibit “B”, Plat and Plans.

(v) “*Phase 1 Property*” means the Property described on Exhibit “A” attached hereto, together with all improvements and structures erected, constructed or contained therein or thereon, and all easements, rights and appurtenances belonging thereto, and all fixtures and equipment intended for the mutual use, benefit or enjoyment of the Unit Owners submitted to the provisions of the Act pursuant to this Declaration or any amendment hereto, as a condominium. The Phase 1 Property is sometimes referred to as the “*Property*” which term expressly excludes the Additional Property until and in the event such Additional Property or portions thereof are submitted to this Declaration in accordance with the terms hereof, at which time those portions of the Additional Property submitted thereto shall be deemed to be a part of the “*Property*”.

(w) “*Purchaser*” means any Person, other than the Declarant, who, by means of a voluntary transfer, acquires a legal or equitable interest in a Unit other than (a) a leasehold interest in a Unit of less than twenty (20) years, including renewal options, with the period of the leasehold interest, including renewal options, being measured from the date the initial term commences, or (b) a Security Interest.

(x) “*Real Estate*” means any leasehold or other estate or interest in, over, or under land, including structures, fixtures, and other improvements and interests that, by custom, usage, or law, pass with a conveyance of land though not described in the contract of sale or instrument of conveyance. Real Estate includes parcels with or without horizontal boundaries and spaces that may be filled with air or water.

(y) “*Rules and Regulations*” means any instruments, however denominated, which are adopted by the Association for the regulation and management of the Condominium, including any amendments to those instruments.

(z) “*Security Interest*” means an interest in Real Estate or personal property, created by contract or conveyance which secures payment or performance of an obligation. The term includes a lien created by a mortgage deed of trust, trust deed, security deed, contract for deed, land sales contract, lease intended as security assignment of lease or rents intended as security, pledge of an ownership interest in an association, and any other consensual lien or title retention contract intended as security for an obligation.

(aa) “*First Security Interest*” means a Security Interest in a Unit prior to all other Security Interests except the Security Interest for real property taxes and assessments made by Douglas County Nebraska, or other governmental authority having jurisdiction over the Condominium.

(bb) “*Special Assessments*” means the special assessments for Capital Improvements and other items which are described in Article VIII, Paragraph 6 of this Declaration.

(cc) "*Transfer Date*" means the date, which is the earlier of (a) sixty (60) days after the date the Declarant has sold and delivered its deed for at least ninety percent (90%) of the Unit Ownerships of all Units which may be created in each phase of the Condominium (a total of twenty-six (26) Units may be created pursuant to the terms hereof), (b) two (2) years after the Declarant has ceased to offer Units for sale in the ordinary course of business, or (c) the voluntary surrender of any such power by the Declarant, which shall be accomplished by the Declarant's delivery of written notice of such surrender to each Unit Owner.

(dd) "*Unit*" means the physical portion of the Condominium designated for separate ownership or occupancy and the boundaries of which are described in or determined from this Declaration, and shown on the Plat and Plans. A Unit includes the heating, water and electrical apparatus exclusively serving such Unit, whether or not located within the boundaries of the Unit.

(ee) "*Unit Owner*" means the Declarant or other Person who owns a Unit but does not include a Person having solely a Security Interest in a Unit. The Declarant is the Unit Owner of any Unit created in this Declaration until that Unit is conveyed to another Person.

(ff) "*Unit Ownership*" means a part of the Property consisting of one Unit and its undivided interest in the Common Elements appurtenant thereto. A Unit Ownership shall include (a) a fee simple interest in the Unit, and (b) an undivided interest in the Common Elements of the Condominium.

Section 2.2 Other Terms Defined in Act. Unless the context clearly indicates otherwise, other terms defined in the Act shall have the meanings attributable to such terms in the Act.

Section 2.3 Other Terms in Declaration. The other terms in this Declaration shall be defined in specific provisions contained herein and shall have the meaning assigned by such definition.

ARTICLE III CONDOMINIUM INFORMATION

Section 3.1 Name. The name of the Condominium is Antler View Office Condominiums.

Section 3.2 Association. The name of the Association is Antler View Office Owners Association, Inc., a Nebraska nonprofit corporation.

Section 3.3 County. The name of every county in which any part of the Condominium is situated is Douglas County, Nebraska.

Section 3.4 Legal Description. The legal description of the Property included in the Condominium is set forth in Exhibit "A" attached hereto.

Section 3.5 Number of Units. As set forth in the Plat and Plans, the Phase 1 Property shall consist of one (1) Building containing six (6) Units in total. The anticipated number of Units

that the Declarant reserves the right to create within the Condominium is twenty-six (26), including four (4) additional Units on the Phase 1 Property.

Section 3.6 Boundaries and Description of Condominium Unit.

(a) Each Unit consists of the space enclosed and bounded by the horizontal and vertical planes set forth in the Plat and Plans including, without limitation, the following as it relates to Units: pipes, ducts, flues, chutes, conduits, wires, and other utility, heating, cooling or ventilation systems or equipment to the extent and only to the extent serving only such Unit; and (anything herein to the contrary notwithstanding) excluding all structural components of the Building, the term "structural components" including structural columns or pipes, wires, conduits, ducts, flues, shafts, or public utility lines running through the Unit and forming a part of any system serving more than the Unit, or any components of communication, cable television systems, or internet service systems, if any, located in the Unit, whether or not any such items shall be located in the floors, ceilings or perimeter or interior walls of the Unit.

(b) To the extent such data is available to the Declarant at the time this Declaration is filed, the Plat and Plans shall set forth the measurements, elevations, locations and other data, as required by the Act, with respect to (i) the Property and its exterior boundaries; (ii) the Building and each floor thereof; and (iii) each Unit in the Building and such Unit's horizontal and vertical dimensions. However, the Declarant hereby reserves unto itself and the Association, the right, from time to time, as further data becomes available, to amend the Plat and Plans so as to set forth the measurements, elevations, locations and other data required by the Act, with respect to the Building and the Units now or hereafter constructed on the Property. In furtherance of the foregoing, a power coupled with an interest is hereby granted to the Declarant, acting by or through its duly authorized officers, its successors, or its designee, as attorney-in-fact, to amend the Plat and Plans, as described above, without notice to any Unit Owner or mortgagee. Each deed, mortgage or other instrument with respect to a Unit, and the acceptance thereof, shall be deemed a grant of such power to each of these attorneys-in-fact, and acknowledgment of and consent to such power, and shall be deemed to reserve to each of these attorneys-in-fact the power to amend the Plat and Plans, as described above.

(c) After the Plat and Plans and this Declaration have been recorded in the office of the Register of Deeds of Douglas County, Nebraska, every contract, deed, lease, Security Interest, trust deed, will or other instrument may legally describe a Unit as follows:

Condominium Unit _____, in accordance with the Master Deed and Declaration of Condominium Ownership for Antler View Office Condominiums, dated _____ and recorded _____, 2019, Instrument No. _____ in the Office of the Douglas County Register of Deeds.

Every such description shall be good and sufficient for all purposes to sell, convey, transfer, encumber, or otherwise affect not only the Unit, but also the undivided interest in the Common Elements appurtenant to said Unit and all other appurtenant properties and property rights, and incorporate all of the rights and burdens incident to ownership of a Condominium Unit and all of the limitations thereon as

described in this Declaration and the Plat and Plans. Each such description shall be construed to include a non-exclusive easement for use of all of the Limited Common Elements appurtenant to said Unit, and all the general Common Elements.

Section 3.7 Limited Common Elements. The Limited Common Elements are set forth on the Plat and Plans, and are designated thereon. Limited Common Elements also include those items in §76-839 of the Act, unless specifically provided for to the contrary herein.

Section 3.8 Development Rights and Special Declarant Rights. Declarant reserves the right, in addition to other rights reserved pursuant to the Act, to perform any acts, including but not limited to any Special Declarant Rights as defined in Article XVI, necessary to complete the construction of the improvements upon the Property including all Buildings, Units, Common Elements, Limited Common Elements and all structures and items related thereto. Declarant reserves the right to combine or subdivide any Units. Declarant reserves the right to convert any Unit to Common Elements or Limited Common Elements. In addition, the Declarant, and/or its successors and assigns and their respective agents, shall have the right and privilege to create additional Units, Common Elements, and/or Limited Common Elements within all or any part of the Property and/or Additional Property, which Additional Property may be designated on the Plan as "Additional Property" or as "Reserved" or "Reserved for Future Development"; and to add property to the Condominium, provided, however, that the maximum number of additional Units which the Declarant reserves the right to create shall not exceed twenty-six (26) Units. Upon the addition of any Units to the Condominium, the Allocated Interests shall be reallocated among all units pursuant to the terms of this Declaration and the formula set forth herein. The future improvements will be consistent with the initial improvements in structure type and quality of construction. The creation of the additional Units, if any, shall occur within seven (7) years after the recording date of this Declaration in the Office of the Douglas County Register of Deeds.

Section 3.9 Recording Data. All easements and licenses to which the Condominium is presently subject are set forth on the Plat and Plans.

Section 3.10 Notices. Notice of matters affecting the Condominium may be given to Unit Owners by the Association or by other Unit Owners in the following manner: Notice shall be hand-delivered or sent by United States mail postage prepaid, to the mailing address of each Unit or to any other mailing address designated in writing by the Unit Owner to the Association. Such notice shall be deemed given when hand-delivered or when deposited in the United States mail, postage prepaid.

Section 3.11 Use of Units. The Property is intended to be used for office use and professional services. Each Unit Owner, its heirs, successors and assigns, covenants it will not use, cause or permit its Unit to be used other than as provided in this Declaration, without having obtained (i) unanimous approval of the Unit Owners and (ii) an Amendment to this Declaration in accordance with §76-854 of the Act. Office uses are defined as those uses that conduct the affairs of a business, profession, service, industry or government. These activities do not include the production, sale or repair of goods on site. Professional services uses provide services (work done for others) as opposed to products sold or repaired to the general public. These uses include but are limited to: (a) contractor's office, developer's office, builder's office; (b) educational organizations for office use; (c) financial institutions; (d) health services, including medical and dental services; (e) insurance agency; (f) interior decorating; (g) personal service agency; (h) professional consultant; (i) real estate agency, title agency, appraisal

company; (j) social service agency; (k) professional engineering and surveying offices (l) law offices; and (m) accounting offices.

Section 3.12 Residential Use Prohibited. The Units shall not be used by the Owners or occupants or their guests for residential purposes.

Section 3.13 Use of Units Owned by Declarant. Declarant may maintain sales offices and/or management offices in any and all Units owned by it or any of its members, or owned by any business entity of which it or any of its members is an owner. The number, size and location of such offices shall be related directly to those Units so owned. The offices may be relocated as ownership of the relevant Units changes.

Section 3.14 Easement Rights. In addition to any exclusive easements established in the Limited Common Elements, each of the Units and Common Elements shall also be subject to the following nonexclusive easements which shall be easements appurtenant to and running with the land, perpetually in full force and effect:

(a) Appurtenant to each Unit shall exist a nonexclusive easement: (1) over all the Common Elements for ingress, egress, utility services, support, maintenance and repairs to the Units; (2) over the Limited Common Elements as necessary for structural support, utility services, maintenance and repairs; and (3) over all parts of the Condominium and Property (including all other Units and Limited Common Elements) for structural support.

(b) Should any part of the Common Elements encroach upon any Unit or Limited Common Element, a valid nonexclusive easement shall exist for such encroachment and its maintenance. In the event any improvement constituting part of the Condominium shall be partially or totally destroyed and then rebuilt, minor encroachments of any parts of the Common Elements due to construction shall be permitted, and valid nonexclusive easements shall exist for such encroachments and their maintenance. A valid easement also exists with respect to that portion of the Common Elements occupied by any part of a Unit not contained within the physical boundaries of such Unit, including but not limited to, space occupied by heating and air conditioning equipment, utility lines and similar equipment which serves only one Unit.

(c) Declarant and its successors and assigns (including but not limited to the Association) shall have an easement through the Common Elements as is reasonably necessary for the purpose of discharging Declarant's obligations or exercising Special Declarant Rights (defined below).

(d) Declarant and its successors and assigns (including but not limited to the Association) shall have, and are hereby granted the right and easement (to be exercised by any officers, agents, employees or independent contractors) to enter any Unit and any Limited Common Elements from time to time during reasonable hours, provided at least twenty-four (24) hours advance notice is given to the particular Unit Owner (except that access may be had at any time in case of emergency), (1) for purposes of reconstructing, making repairs or performing maintenance, or (2) for essential operations of the Condominium or (3) to prevent damage to any Units or Common Elements. In addition, the Declarant shall have all other easements and rights granted under the Act.

ARTICLE IV MEMBERSHIP, VOTING RIGHTS AND ALLOCATIONS

Section 4.1 Membership. Every Unit Owner shall be a Member of the Association and, by its purchase or acquisition and ownership of a Unit, shall be deemed to have agreed to be bound by all provisions of this Declaration and all amendments, as well as all other Association documents, including but not limited to, the Bylaws and Rules and Regulations. No Unit Owner may avoid the obligations and burden coincident to Unit Ownership or membership in the Association. The foregoing is not intended to include Persons who hold only a Security Interest. Membership shall be appurtenant to and may not be separated from ownership of any Unit which is subject to Common Expense Assessments by the Association. Ownership of such Unit shall be the sole qualification for membership. Where there is more than one (1) record owner of a Unit ("co-owners"), all of the co-owners may attend any meeting of the Association, but for the purposes of voting, only one (1) of the co-owners shall be entitled to exercise all of the votes allocated to the Unit.

Section 4.2 Voting Rights and Assignment of Votes. The effective date for assigning votes to Units created pursuant to this Declaration shall be the date on which this Declaration is recorded in the records of the Register of Deeds of Douglas County, Nebraska.

Section 4.3 Allocated Interests. The undivided interest in the Common Elements, Common Expense Liability, and votes in the Association shall be allocated among the Unit Owners as follows:

(a) Each Unit Owner's share of the undivided interest in the Common Elements and Common Expenses shall be a fraction, the numerator of which shall be the square footage of the Unit and the denominator of which shall be the total square footage of all Units in the Condominium.

(b) The total number of votes of all Unit Owners shall be equal to the total number of Units at that time. In all elections for Executive Board Members and in all other actions requiring a vote of the members of the Association, each Unit Owner shall be entitled to one (1) vote for each Unit owned.

The undivided interest in the Common Elements and Common Expenses, and the votes in the Association for each Unit are set forth in the Unit Ownership and Percentage Interests table, attached hereto as Exhibit "C". In the event of addition or withdrawal of Units from the Condominium, the percentage interest of each Unit Owner in the Common Elements and Common Expenses, and the votes in the Association for each Unit shall be adjusted accordingly. In the event any portion of the Additional Property is added to the Condominium, then the percentage interest or share so allocated, being the Unit's undivided interest in the Common Elements appertaining to such Unit, shall be allocated and reallocated, respectively, in the same manner as the allocation of undivided interests was done for Units previously existing in the Condominium, to wit, each Unit in the Condominium shall be allocated a percentage interest, being an undivided interest in the Common Elements, determined by the method set forth in this Section 4.3.

Section 4.4 Deadlock Resolution. If any matter requiring the vote or approval of a majority of the Members of the Association should receive the approval of Members holding exactly one-half of all interest entitled to vote thereon, the matter shall be submitted for resolution by an arbitrator designated in writing by a majority of the Members. In the event that a

majority of the Members is not able to designate an arbitrator, then the matter shall be arbitrated by an arbitrator pursuant to the then-existing rules and regulations of the Center for Public Resources Rules for Non-Administrated Arbitration of Business Disputes. The decision of the arbitrator regarding the resolution of any such deadlock shall be binding upon the Association and all Members for all purposes. Additionally, in the event one of the Members is unable to reach a consensus sufficient to cast a vote on any matter requiring the vote or approval the Members, such Member's vote shall not be counted, and the remaining Members' votes will dictate the result of the voting process.

ARTICLE V ASSOCIATION AND EXECUTIVE BOARD

Section 5.1 Authority and Power. The business and affairs of the Condominium shall be managed by the Association. The administration of the Condominium shall be governed by the Bylaws and the Act. The Association shall have all of the powers, authority and duties permitted pursuant to the Bylaws and the Act which are necessary and proper to manage the business and affairs of the Condominium.

Section 5.2 Membership. The Executive Board shall consist of Members or representatives of a Member elected in accordance with the Association's Bylaws.

Section 5.3 Executive Board Powers and Duties. The Executive Board may act in all instances on behalf of the Association, except as provided in this Declaration or the Bylaws. The Executive Board shall have, subject to the limitations contained in this Declaration and the Act, the powers and duties necessary for the administration of the affairs of the Association and of the Condominium, including but not limited to the following:

- (a) Adopt and amend Bylaws;
- (b) Adopt and amend Rules and Regulations regarding the use and enjoyment of the Common Elements, and the activities of occupants thereon;
- (c) Adopt and amend budgets for revenues, expenditures and reserves;
- (d) Collect Assessments from Unit Owners;
- (e) Collect amounts necessary to cover any shortage in revenue due to under-budgeting or due to failure to ratify a budget;
- (f) Hire and discharge Managers, independent contractors and other employees and agents;
- (g) Institute, defend or intervene in litigation or administrative proceedings or seek injunctive relief for violation of the Bylaws in the Association's name, on behalf of the Association or two (2) or more Unit Owners on any matters affecting the Condominium;
- (h) Make contracts and incur liabilities;
- (i) Regulate the use, maintenance, repair, replacement and modification of the Common Elements;

(j) Cause additional improvements to be made as a part of the Common Elements;

(k) Acquire, hold, encumber and convey in the Association's name, any right, title or interest to real or personal property, except for Common Elements which may be conveyed or subjected to a Security Interest only pursuant to §76-870 of the Act;

(l) Grant easements for any period of time, including permanent easements, leases, licenses and concessions through or over the Common Elements; provided, however, no such easements shall unreasonably interfere with the use of operation of any Unit, access points, utilities or the parking areas within the Condominium;

(m) Impose and receive payments, fees or charges for the use, rental or operation of the Common Elements, other than the Limited Common Elements described in §76-839(2) and (4) of the Act, and for services provided to Unit Owners;

(n) Impose reasonable charges for late payment of Assessments, recover reasonable attorneys' fees and other legal costs for collection of Assessments and other actions to enforce the power of the Association, regardless of whether legal proceedings were initiated, and after notice and an opportunity to be heard, levy reasonable fines for violation of this Declaration, the Bylaws or other Association documents;

(o) Impose reasonable charges for the preparation and recordation of supplements or amendments to this Declaration, for resale statements required by §76-884 and for statements of unpaid Assessments;

(p) Provide for the indemnification of the Association's officers and the Executive Board and maintain Directors' and Officers' liability insurance;

(q) Make Assessments for legal, accounting and other professional employment regarding taxes, legal and general advice;

(r) Exercise any other powers conferred by this Declaration, the Bylaws or other Association documents;

(s) Exercise all other powers that may be exercised in this state by legal entities of the same type as the Association;

(t) Exercise any other powers necessary and proper for the governance and operation of the Association;

(u) By resolution establish permanent and standing committees of Executive Board members to perform any of the above functions under specifically delegated administrative standards as designated in the resolution establishing the committee. All committees must maintain and publish notice of their actions to Unit Owners and the Executive Board. Actions taken by a committee may be appealed to the Executive Board by any Unit Owner within forty-five (45) days of publication of a notice. If an appeal is made, the committee's action must be ratified, modified or rejected by the Executive Board at its next regular meeting, or at a special meeting called for that purpose;

(v) Exercise all other powers necessary and proper to ensure that the Common Elements conform to all applicable federal, state and local laws, statutes, ordinances, and regulations. Specifically, and without limitation, the Association may ensure that the Common Elements and the use thereof comply with the federal Americans with Disabilities Act, and all hazardous materials laws.

Section 5.4 Professional Management and Contract Termination Provisions. The Association may utilize professional management in performing its duties hereunder. Any contracts, licenses or leases entered into by the Association while there is Declarant control of the Association may be terminated pursuant to §76-863 of the Act.

Section 5.5 Executive Board Limitations. The Executive Board may not act on behalf of the Association to amend this Declaration, to terminate the Condominium, or to elect members of the Executive Board or determine their qualifications, powers and duties or the terms of office of Executive Board members, but the Executive Board may fill vacancies in its membership for the unexpired portion of any term.

Section 5.6 Executive Board Standard of Care. The Executive Board officers and members shall exercise ordinary and reasonable care in the performance of their duties.

ARTICLE VI COMMON ELEMENTS

Section 6.1 Dedication of Common Elements. Declarant hereby dedicates the Common Elements to the common use and enjoyment of the Members, as hereinafter provided.

Section 6.2 Description of Common Elements. The Common Elements within the Condominium shall consist of the following property, easements and such additional Common Elements as shall be conveyed to the Association in the future.

(a) The Phase 1 Property upon which the Buildings containing the Units are located, and such structures themselves, including the foundations, exterior walls, roofs, gutters, downspouts, chutes, chases, flues, ducts, wires, conduits, bearing walls, bearing columns, fire suppression and detection systems, whether situated partially within or outside the boundaries of any Unit, including without limitation all piping, fittings, valves and sprinkler heads, or any other fixtures which lie partially within and partially outside of the designated boundaries of a Unit and which serve more than one Unit and are not otherwise assigned or allocated to any one or more Units as a Limited Common Element.

(b) Easements. The Common Elements include the right to maintain and use, and to the extent necessary for the Association to perform its duties with respect to the Common Elements, all utility easements, access easements, pedestrian access easements and landscaping easements as shown on the Plat and Plans. Nothing in this Article shall be construed as creating an ownership interest by the Association in said easements.

(c) Landscaping. All existing lawns, shrubs, bushes, trees, flowers other plants and landscaping materials.

(d) Parking Facilities and Driveways. All parking areas, including curbs and gutters not maintained by Douglas County, Nebraska or, if applicable at a later date, the City of Omaha, driveways and lighting components related to the parking areas and driveways.

(e) Sidewalks. All sidewalks leading to exterior entrances of the Building(s) or otherwise utilized by the general public.

(f) Water Facilities. All underground water lines, up to the point at which such water lines enter a Unit, or the point at which a Unit's shutoff valve is located, whichever is further from the Unit. Underground sprinkler systems, including lawn and landscape sprinkler systems now in existence or installed in the future.

(g) Miscellaneous Improvements. All other improvements installed by the Association within any utility easements, access easements, pedestrian access easements, and/or landscaping easements.

(h) Walls, Floors or Ceilings. All portions of the walls, floors or ceilings not within Unit boundaries shall be part of the Common Elements.

(i) Exclusion. Specifically excluded from Common Elements (but not necessarily excluded from Limited Common Elements) are patios, balconies, awnings or shades, building interiors, or any part or extension thereof, including, but not limited to, shutters, lights, antennas, doors, windows, flagpoles, decorative hardware, window boxes, chimneys, wires, conduits, foundations, loading docks, and like items.

(j) Real Property. Common Elements does not include any ownership interest in any real property, including easements.

Section 6.3 Maintenance, Repair and Replacements of Common Elements. The Association, at its expense, shall be responsible for the maintenance, repair and replacement of those portions, if any, of each Unit which contribute to the support of the Building, but excluding all exterior doors and the interior surfaces of walls, ceilings and floors. In addition, the Association shall maintain, repair, and replace all pipes, wires, conduits, ducts, shafts and other facilities for the furnishing of utility services which may be located within the Unit boundaries and forming part of any system servicing more than one Unit, exclusive of any portions of the foregoing which may be located at or beyond the wall outlets, or which may be the responsibility of an individual Unit Owner under Article VII below, or any other provision of this Declaration. Maintenance, repairs and replacements of the Common Elements (but not Limited Common Elements except as provided in Article VII hereof), shall be furnished by the Association acting by and through the Executive Board as part of the Common Expenses, subject to the Bylaws or rules and regulations of the Association.

Section 6.4 Common Utilities. The Association shall charge each Unit Owner an allocated share of the utilities for maintenance of the Common Elements, including but not limited to, water, sewer and electricity for exterior building and/or parking lot lighting, which allocated share shall be part of the regular Assessment described in Article VIII and shall be based upon the Unit Owner's Common Expense Liability, as set forth in Article IV and Exhibit "C" attached hereto.

Section 6.5 Unit Owner's Easements of Enjoyment. Each Unit Owner shall have a right and easement of enjoyment in and to the Common Elements and such easement shall be appurtenant to and shall pass with title to every Unit, subject to the following provisions:

(a) The right of the Association to promulgate and publish reasonable Rules and Regulations as provided in this Declaration.

(b) The right of the Association to suspend voting rights and the right to use the Common Elements by a Unit Owner for any period during which any Assessment against his or her Unit remains unpaid; and for a period not to exceed sixty (60) days for any infraction of its published Rules and Regulations.

(c) The right of the Association to dedicate or transfer any part of the Common Elements to any public agency, authority, utility or other entity for such purposes and subject to such conditions as may be agreed to by the Members, provided that no such dedication or transfer shall be effective unless approval is obtained from the Unit Owners. An agreement to dedicate, transfer or convey all or any part of the Common Elements must be evidenced by execution and recordation of an agreement or ratification thereof, in the same manner as a deed by the requisite number of Unit Owners. Such agreement must specify a date after which the agreement will be void unless recorded before that date.

(d) The right of the Association to close or limit use of the Common Elements while maintaining, repairing and making replacements in or to the Common Elements.

Section 6.6 Delegation of Use. Unit Owners may delegate in accordance with the Bylaws their right of enjoyment to the Common Elements and facilities, but not their voting rights, to their tenants or contract Purchasers who occupy the relevant Unit.

Section 6.7 No Partition of Common Elements. The Common Elements are not subject to partition, and any purported conveyance, encumbrance, judicial sale, or other voluntary or involuntary transfer of an undivided interest in the Common Elements made without the Unit to which that interest is allocated is void.

Section 6.8 No Severance of Ownership. No Unit Owner shall execute any deed, mortgage, lease or other instrument affecting title to such Unit Owner's Unit Ownership without including therein both such Unit Owner's interest in the Unit and such Unit Owner's corresponding percentage of ownership in the Common Elements, it being the intention hereof to prevent any severance of such combined ownership. Any such deed, mortgage, lease or other instrument purporting to affect the one without including also the other shall be deemed and taken to include the interest so omitted even though the latter is not expressly mentioned or described therein.

ARTICLE VII LIMITED COMMON ELEMENTS

Section 7.1 Limited Common Elements. The Limited Common Elements are such parts of the Common Elements serving exclusively a single Unit or adjoining Units as an inseparable appurtenance thereto, as designated as such in this Declaration, included in the Plat and Plans, or which by the nature or location thereof, or by the terms of this Declaration, are clearly intended to be reserved for or for the use of one or more Units to the exclusion of

other Units. The Limited Common Elements appertaining to, or designated or reserved for or for the use of, or serving any Unit (alone or in conjunction with other Units) are hereinafter from time to time referred to as the Limited Common Elements of such Unit. The Limited Common Elements shall include, but shall not be limited to, the following: (a) the interior surface of the perimeter walls, ceilings and floors which define the boundary planes of a Unit; (b) perimeter doors and windows, including skylights, if any, which serve exclusively a single Unit (including, without limitation, any Unit plate glass windows); (c) any system or component part thereof (including, without limitation, flues, furnaces, fittings, housings, ducts, flues, shafts, electrical wiring and conduits) which serves a Unit exclusively, to the extent that such system or component part is located outside the boundaries of a Unit; and (d) the monument sign shown on Exhibit "B" attached hereto (the "Monument Sign").

Section 7.2 Use of Limited Common Elements. Each Unit Owner shall have the right to (a) the exclusive use and possession of the Limited Common Elements serving exclusively the Unit of such Unit Owner, which right shall be appurtenant to and shall run with title to such Unit, and shall not be separated from such Unit, and (b) the use and possession of the Limited Common Elements serving the Unit of such Unit Owner in common with one or more (but not all) other Units, which use and possession shall be to the exclusion of all other persons except the Unit Owner of any such other Unit to which such Limited Common Elements shall respectively appertain.

Section 7.3 Allocation of Specified Common Elements. The Executive Board may designate part of the Common Elements from time to time for use by less than all of the Unit Owners or by non-owners for specified periods of time or by only those persons paying fees or satisfying other reasonable conditions for use as may be established by the Executive Board. Any such designation by the Executive Board shall not be a sale or disposition of such portion of the Common Elements.

Section 7.4 Expense Allocation. Except as set forth below in Section 7.7, any Common Expense associated with the maintenance, repair, or replacement of a Limited Common Element shall be assessed against the Units to which the Limited Common Element is assigned, unless such repair or replacement is caused by a casualty to the extent such injury or damage is insured under any valid and collectible insurance policies insuring the Association against such loss or damage.

Section 7.5 Maintenance, Repair and Replacements of Limited Common Elements. Except as otherwise provided in Article VI above and Section 7.7 below, each Unit Owner shall furnish and be responsible for, at its own expense:

- (a) All of the maintenance, repairs and replacements within such Unit Owner's Unit, all interior and exterior doors appurtenant thereto, all windows and window screens which serve exclusively a single Unit, and all internal installations of such Unit such as refrigerators, ranges, and other kitchen appliances, lighting fixtures and other electrical fixtures and plumbing and any portion of any other utility service facilities located within the Unit; provided, however, that such maintenance, repairs and replacements as may be required for the bringing of water and electricity to the Units, shall be furnished by the Executive Board as part of the Common Expenses. No Unit Owner may change the appearance of any exterior doors without prior written approval by the Architectural Control Committee.

(b) All of the decorating within such Unit Owner's Unit (initially and thereafter from time to time), including, but not limited to, painting, wall papering, washing, cleaning, paneling, floor covering, draperies, window shades, curtains, lamps and other furnishings and interior decorating. Each Unit Owner shall be entitled to the exclusive use of the interior surfaces of the common walls and the interior surfaces of the vertical perimeter walls, floors and ceiling of such Unit Owner's Unit, and such Unit Owner shall maintain such portions in good condition at his or her sole expense as may be required from time to time. Each Unit Owner who shall elect to alter such Unit Owner's Unit by installing in any portion of that Unit (other than in bathrooms) hard surface floor covering (i.e., tile, slate, ceramic, parquet, etc.) shall be first required to install a sound absorbent under-cushion of such kind and quality as to prevent the transmission of noise to another Unit or as may otherwise be required by the Association. The Executive Board may, in addition to exercising all of the other remedies provided for in this Declaration for breach of any of the provisions hereof, require such Unit Owner to cover all non-conforming work with carpeting, or may require removal of such non-conforming work, at the expense of the offending Unit Owner. The interior surfaces of all windows forming part of a perimeter wall of a Unit shall be cleaned or washed by and at the expense of each respective Unit Owner. The use of and the covering of the interior surfaces of such windows, whether by draperies, shades, or other items visible on the exterior of either of the Building, shall be subject to the rules and regulations of the Executive Board as may be imposed from time to time, which shall provide for notice to the management company prior to any such installation and the management company's approval of the method of installation prior to any such installation.

(c) All of the maintenance, repair, and replacements of the Limited Common Elements benefiting such Unit Owner's Unit, in whole or in part, except to the extent as otherwise directed by the Executive Board or as is otherwise provided herein. In addition, each Unit Owner shall be individually responsible for the repair, maintenance and replacement of all door and window locks and hardware with respect to which each Unit Owner is entitled to the exclusive use. At the discretion of the Executive Board, the Executive Board may perform, or cause to be performed, such maintenance, repairs, and replacements of the Limited Common Elements and the cost thereof shall be assessed in whole or in part to the Unit Owners benefited thereby, and further, at the discretion of the Executive Board, the Executive Board may direct such Unit Owners, in the name and for the account of such Unit Owners, to arrange for such maintenance, repairs, and replacements, to pay the cost thereof with the funds of the Unit Owner, and to procure and deliver to the Executive Board such lien waivers and contractor's or subcontractor's sworn statements as may be required to protect the Property from all mechanics' or materialmen's lien claims that may arise therefrom.

Section 7.6 Mechanics' Liens and Materialmen's Liens. No labor performed or materials furnished and incorporated in a Unit, notwithstanding the consent or request of the Unit Owner, his agent, contractor or subcontractor, shall be the basis for filing a lien against the Common Elements. Each Unit Owner shall indemnify and hold harmless each of the other Unit Owners and the Association from and against all losses, damages, costs and expenses, including, without limitation, reasonable attorneys' fees, arising from any lien against the Unit of any other Unit Owner or against the Common Elements for construction performed or for labor, materials, services or other products incorporated in the indemnifying Owner's Unit or such Owner's request.

Section 7.7 Monument Sign. The Monument Sign shall be placed in the location set forth on Exhibit "B" attached hereto. Each Unit Owner shall be entitled to one (1) space/slot on Monument Sign, provided that, except as set forth on Exhibit "B", any such signage (including the location on the Monument Sign) or modifications thereto, shall receive the prior approval of the Architectural Control Committee in the manner set forth in Article XII, below and that any such signage shall be installed at each Unit Owner's sole cost and expense.

ARTICLE VIII ASSESSMENTS

Section 8.1 Covenant for Assessments. Each Unit Owner shall pay to the Association its Allocated Interest of all general and special condominium assessments levied by the Executive Board for Common Expenses pursuant to this Declaration, which Allocated Interest shall be the Unit Owner's Common Expense Liability, as set forth in Article IV and Exhibit "C" attached hereto. Such assessments, together with such interest and late charges thereon and costs of collection thereof (including reasonable attorneys' fees), as hereinafter provided, shall be a charge on the land and shall be a continuing lien upon the Unit against which each such assessment is made, subject to Article XV hereof. Each such assessment, together with such interest, late charges and costs of collection, shall also be the personal obligation of the person who was the Unit Owner of such Unit at the time when the assessment fell due. Except as otherwise provided in this Declaration, such personal obligation shall pass to such Unit Owner's successors in title if not fully discharged by the transferor Unit Owner prior to any transfer of such Unit. In addition to the annual assessments authorized above, the Association may levy special assessments for the purpose of defraying, in whole or in part, the cost of any construction or reconstruction, unexpected repair, maintenance or replacement item not contemplated in the annual budget. The foregoing special assessments may be levied notwithstanding the fact that the Association may have then accumulated a reserve.

Section 8.2 Working Capital Fund. Upon acquisition of record title to a Unit following any conveyance of a Unit, each Purchaser of a Unit shall contribute to the working capital fund of the Association an amount equal to the then-current annual Common Expense Assessment levied or to be levied against such Unit in the year the acquisition/transfer occurs. This amount shall be deposited by the Purchaser of such Unit into an escrow established in connection with the closing of the purchase and sale of the Unit and disbursed therefrom to the Association, which shall hold such funds for the use and benefit of the Association. The Declarant shall have no obligation to make contributions to the working capital fund, provided that the foregoing shall not relieve Declarant of its obligation to pay assessments relating to periods while it retains ownership of Units. The purpose of the working capital fund is to ensure that the Executive Board will have cash available to meet unforeseen expenditures, or to acquire additional equipment or services deemed necessary or desirable by the Executive Board. Amounts paid into the fund are not to be considered as advance payment of regular Assessments.

Section 8.3 Purpose and Use of Assessments. The assessments levied pursuant to this Declaration shall be used for the purpose of promoting the health, safety and welfare of the residents or occupants of the Property and in particular for the improvement and maintenance of the Property, services and facilities devoted to this purpose and related to the use and enjoyment of the Property, and of the Units situated upon the Property, and for such other purposes as may be described in this Declaration.

- (a) Such uses shall include, but are not limited to, the cost to the Association of any and all insurance premiums with respect to, and the expense of operation, repair,

replacement and maintenance of, the Building, Common Elements and other facilities and activities, including, but not limited to, caring for the grounds, maintenance of utilities which serve the Common Elements, landscaping, paving, equipment, sanitary and storm sewer and water service lines which service the Condominium, structures and appurtenances (other than facilities and activities maintained by any governmental authority or utility company), the expenses incurred by the Association or Declarant in connection with the ingress and egress, driveways, sidewalks and other accessways benefiting the Property but which may be located on adjacent property, expenses incurred by the Executive Board in performing its activities authorized hereunder, the expenses incurred by the Committees in performing their respective activities authorized hereunder and other charges required by this Declaration or that the Executive Board shall determine to be necessary or desirable to meet the primary purpose of the Association. In addition, water, waste removal and/or any utilities which are not separately metered or otherwise directly charged to individual Unit Owners shall be paid for by the Association from such assessments. The Executive Board reserves the right to levy additional assessments against any Unit Owner to reimburse it for excessive use by such Unit Owner of any utility or other service. The Executive Board shall, pursuant to the Act, have the power and authority to assess any Common Expenses benefiting fewer than all of the Units exclusively against the Units benefited thereby. Notwithstanding the foregoing, the Executive Board shall not include any item for which Declarant, the Executive Board or the Association are reimbursed by insurance or otherwise compensated in the assessments.

(b) Notwithstanding the foregoing right of the Association and the Executive Board to levy assessments, prior to the Transfer Date, the Association may not include in the Common Expense Liability, the following expenses incurred by the Association or Declarant:

- (i) Payments or principal or interest related to any financing obtained in connection with the original construction or design of the Buildings or any expansion thereof;
- (ii) Legal and other fees, leasing commissions, advertising expenses and other costs incurred in connection with the development, selling, leasing and re-leasing of any portion of the Condominium;
- (iii) Any interest or penalties incurred as a result of Declarant's failure to pay a bill as the same shall become due;
- (iv) Any and all costs associated with the operation of Declarant; or
- (v) Any expense due to the gross negligence of Declarant.

Section 8.4 Annual Common Expense Assessments. The total annual Common Expense Assessments against all Units shall be based upon the Association's advance budget of the cash requirements needed by it to provide for the administration and performance of its duties during such Common Expenses Assessments year.

Section 8.5 Budget. The Executive Board shall fix the amount of the annual Common Expense Assessments against each Unit at least annually. Adjustments to the budget may be made by the Executive Board more frequently. Written notice of the Common Expense

Assessments shall be sent to every Unit Owner subject thereto. After the first budget year of the Association, within thirty (30) days after adoption of a proposed budget for the Condominium, the Executive Board shall mail by ordinary first-class mail, or otherwise deliver a summary of the budget to all Unit Owners and shall set a date for a meeting of the Unit Owners to consider ratification of the budget. The meeting shall be not less than fourteen (14) nor more than thirty (30) days after mailing or other delivery of the summary. Unless at that meeting a majority of all Unit Owners reject the budget, the budget shall be ratified, whether or not a quorum is present. If the proposed budget is rejected, the periodic budget last ratified by the Unit Owners shall continue until the Unit Owners ratify a new budget proposed by the Executive Board. The failure or delay of the Executive Board to give notice to each Unit Owner of the annual budget shall not constitute a waiver or release in any manner of such Unit Owner's obligation to pay such Unit Owner's respective monthly assessment, as herein provided, whenever the same shall be determined, and in the absence of the annual or adjusted budget, the Unit Owner shall continue to pay monthly assessment at the then existing monthly rate established for the previous period until the monthly assessment which is due more than ten (10) days after notice is given of such new annual budget.

Section 8.6 Special Assessments. In addition to the Common Expense Assessments authorized above, subject to the exclusions set forth in Section 8.3(b), the Association may at any time, from time to time, determine, levy and assess Special Assessments for the purpose of defraying in whole or in part, payments for any construction reconstruction, repair, demolition, replacement or maintenance of the Common Elements or for Capital Improvements. Any such Special Assessments made by the Executive Board must be approved by not less than Seventy-Five Percent (75%) of the Members who are voting in person or by proxy at a meeting duly called for that purpose. The amounts determined, levied and assessed pursuant hereto shall be assessed proportionately against each Unit, in accordance with Article IV, Paragraph 3. Notice in writing setting forth the amount of such Special Assessments per Unit and the due date for payment thereof shall be given to the Unit Owners not less than thirty (30) days prior to such due date.

Section 8.7 Notice and Quorum. Written notice of any meeting called for the purpose of taking any action authorized under this Article shall be sent to all Members not less than ten (10) nor more than thirty (30) days in advance of the meeting. The required quorum at the meeting shall be twenty percent (20%) of all votes of the membership and at least one (1) elected officer (whose presence may be counted as part of the 20%).

Section 8.8 Rate of Assessment. Both annual Common Expense Assessments and Special Assessments shall be fixed at a uniform rate for all Units, in accordance with paragraph 4 above. The Assessments for each Unit shall be proportionate to the Common Expense Liability for each Unit.

Section 8.9 Payment of Assessments. Assessments shall be collected monthly, or at such other intervals as determined by the Executive Board, but in no event less than annually. The due dates shall be established by the Executive Board. Payment for Assessments shall be delinquent if not received on or before the tenth (10th) day after the due date. The Executive Board may establish and charge a late fee for failure to pay Assessments when due. The Executive Board shall fix the amount of the annual assessment against each Unit at least thirty (30) days in advance of each annual assessment period. Written notice of the annual assessment shall be sent to every Owner subject thereto.

Section 8.10 Date of Commencement: Annual Common Expense Assessments. The Assessments provided for herein shall commence as to all Units on the first day of the month following the conveyance of a Unit by the Declarant to a Purchaser. The first annual assessment shall be adjusted according to the number of months remaining in the calendar year.

ARTICLE IX ASSOCIATION'S LIEN

Section 9.1 Association Lien and Effect of Non-Payment of Assessments. The Assessments including all charges, fees, fines, impositions, interest, costs, late charges, expenses and reasonable attorneys' fees which may arise under the provisions of this Declaration, also including any installment thereof (collectively "Assessments"), shall be burdens running with, and perpetual liens in favor of the Association upon the specific Unit to which such Assessments apply. Recording of this Declaration constitutes record notice and perfection of the Association's lien. Further recording of a claim of lien for Assessments is not required. Any Assessments provided for in this Declaration which are not fully paid within ten (10) days after the due date thereof shall bear interest at the rate of the lesser of: (i) fourteen (14%) percent per annum, or (ii) the maximum set forth in the Act, from the due date or a date established by the Association, and the Association may assess a late charge thereon which late charge shall also be subject to interest charges. In the event of default in which any Unit Owner does not make payment of any Assessments levied against the Unit Owner's Unit within ten (10) days of the due date, the Executive Board may declare all unpaid Assessments for the pertinent fiscal year immediately due and payable.

The Association may bring an action at law or in equity or both against any Unit Owner personally obligated to pay such overdue Assessments, may foreclose its lien against such Unit Owner's Unit, and may, in its sole discretion, accept a deed in lieu of foreclosure. An action at law or in equity by the Association against a Unit Owner to recover money judgment for unpaid Assessments may be commenced and pursued by the Association without foreclosing or in any way waiving the Association's lien therefor. If any such Assessments are not fully paid when due and the Association commences such action (or counterclaims or cross claims for such relief in any action) against any Unit Owner personally obligated to pay the same, or proceeds to foreclose its lien against the particular Unit, then all unpaid Assessments, and any and all late charges and accrued interest under this Article, the Association's costs, expenses and reasonable attorneys' fees incurred in preparing and recording any lien notice, and the Association's costs of suit, expenses and reasonable attorneys' fees incurred for any such action and/or foreclosure proceedings shall be taxed by the court as a part of the cost of any such action or foreclosure proceeding and shall be recoverable by the Association from any Unit Owner personally obligated to pay the same and from the proceeds of the foreclosure sale of such Unit Owner's Unit. Foreclosure, attempted foreclosure, or failure to foreclose by the Association of its lien shall not be deemed to estop or otherwise preclude the Association from thereafter again foreclosing or attempting to foreclose its lien for any subsequent Assessments not fully paid when due.

The Association, or any other Unit Owner or Person, may bid on or purchase any Unit at foreclosure or other legal sale, and acquire and hold, lease, mortgage, vote the Association votes appurtenant to ownership thereof, convey or otherwise deal with the same. A lien for unpaid Assessments is extinguished unless proceedings to enforce the lien are instituted within six (6) years after the full amount of Assessments becomes due, except that if a Unit Owner subject to a lien under this Article files a petition for relief under the United States

Bankruptcy Code, the time period for instituting proceedings to enforce the Association's lien shall be tolled until ninety (90) days after the automatic stay of proceedings under §362 of the Bankruptcy Code is lifted. In any action by the Association to collect Assessments or to foreclose a lien for unpaid Assessments, the court may appoint a receiver for the Unit to collect all sums alleged to be due from the Unit Owner or a tenant of the Unit Owner prior to or during the pendency of the action. The court may order the receiver to pay any sums held by the receiver to the Association during the pendency of the action to the extent of the Association's Assessments, based on a periodic budget adopted by the Association.

Section 9.2 Priority of Liens. A lien under this Article is prior to all other liens and encumbrances on a Unit except:

- (a) liens and encumbrances recorded before the recordation of this Declaration;
- (b) a First Security Interest on the Unit recorded before the date on which the Assessments sought to be enforced became delinquent; and
- (c) liens for real estate taxes and other governmental assessments or charges against the Unit.

A lien under this Article is also prior to all Security Interests to the extent that the Assessments are based on the periodic budget adopted by the Association and which would have become due in the absence of acceleration during the six (6) months immediately preceding institution by the Association or any party holding a lien senior to any part of the Association's lien created herein, of an action or a nonjudicial foreclosure either to enforce or extinguish the lien. If a holder of a First Security Interest in a Unit forecloses that Security Interest, the Purchaser at the foreclosure sale is not liable for any unpaid Assessments against the Unit which became due before the sale, other than the Assessments which are prior to the Security Interest under this Article of the Declaration. Any unpaid Assessments not satisfied from the proceeds of sale become Common Expenses collectible from all Unit Owners, including the Purchaser. Sale or transfer of any Unit shall not affect the lien for said Assessments except that a sale or transfer of any Unit pursuant to foreclosure of any First Security Interest, or any proceeding in lieu thereof, including deed in lieu of foreclosure, or cancellation or forfeiture of any such executory land sales contracts shall only extinguish the lien of Assessments which became due more than six (6) months immediately preceding institution of an action to enforce either the Association's lien or a Security Interest, and statutory liens recognized under Nebraska law. No such sale, transfer, foreclosure or other proceeding in lieu thereof, including deed in lieu of foreclosure, shall relieve any Unit from liability for any Assessments charges thereafter becoming due, nor from the lien thereof. This Article does not affect the priority of mechanics' or materialmen's liens.

Section 9.3 Certificate of Status of Assessments or other Defaults. The Association, upon written request to the Association's registered agent, personally delivered or delivered by certified mail, first class postage prepaid, return receipt requested, and upon payment of a reasonable fee but in no event more than Twenty Dollars (\$20.00) shall furnish to a Unit Owner or such Unit Owner's designee or to a holder of a Security Interest or its designee, a written statement, in recordable form, setting out the amount of the unpaid Assessments or other defaults against the Unit. The statement must be furnished within fourteen (14) calendar days after receipt of the request and is binding on the Association, the Executive Board and each Unit Owner. A properly executed certificate of the Association as to the status of Assessments on a

Unit is binding upon the Association as of the date of its issuance. Omission or failure to fix Assessments or deliver or mail a statement for any period shall not be deemed a waiver, modification or release of a Unit Owner from his or her obligation to pay the same.

Section 9.4 Exempt Property. The following property subject to the Declaration shall be exempted from the Assessments and liens created herein: (a) all properties to the extent of any easement or other interest therein dedicated and accepted by a municipal or quasi-municipal corporation or other local public utility or authority and devoted to public use; and (b) all Common Elements.

Section 9.5 Common Expenses Attributable to Fewer than All Units.

(a) Assessments to pay a judgment against the Association may be made only against the Units in the Condominium at the time the judgment was entered, in proportion to their Common Expense Liabilities.

(b) If a Common Expense is caused by the misconduct of a Unit Owner the Association may assess that expense exclusively against that Unit Owner's Unit as more fully provided in Article IX, paragraph 6 herein.

(c) Fees, charges, taxes, impositions, late charges, fines, collection costs and interest charged against a Unit Owner pursuant to the Bylaws or the Act are enforceable as Common Expense Assessments.

Section 9.6 Unit Owner's Negligence and Individual Assessments. Notwithstanding anything to the contrary contained in this Declaration, if the need for maintenance or repair of the Common Elements or any improvements located thereon is caused by the willful or negligent act, omission or misconduct of any Unit Owner, or by a tenant, guest, or invitee of such Unit Owner, the costs of such repair and maintenance shall be the personal obligation of such Unit Owner, and any costs (including court costs), expenses and fees, including reasonable attorneys' fees, incurred by the Association for such maintenance, repair or reconstruction shall constitute an "Individual Assessment" and shall be added to and become part of the Assessments to which such Unit Owner's Unit is subject and shall be a lien against such Unit Owner's Unit as provided in this Declaration. In addition, the Executive Board may levy an Individual Assessment against any Unit Owner or his or her Unit if the Unit Owner, its tenants, guests or invitees willfully or negligently fail to comply with the terms and provisions of the Bylaws or other Association documents, resulting in the expenditure of funds by the Association to cause compliance by such Person with the terms and provisions of the Bylaws or other Association documents. The Executive Board shall be entitled to recover all costs (including court costs), expenses and fees, including reasonable attorneys' fees related thereto, whether or not legal proceedings are instituted. An Individual Assessment shall be levied and the amount of the Individual Assessment shall be established only after notice to the Unit Owner and the right to be heard before the Executive Board in connection therewith (the timing of such hearing to be as determined by the Executive Board and set forth in such notice, but in all events not less than ten (10) nor more than thirty (30) days after the date of such notice), provided that any such determination for an Individual Assessment pursuant to the terms of this Article may be appealed by said Unit Owner to a court of law.

ARTICLE X INSURANCE

Section 10.1 Insurance Requirements Generally. To the extent reasonably available, and to the extent the Association deems necessary, the Association shall obtain and maintain the following insurance:

(a) physical damage insurance on the Buildings and improvements upon the Property and all personal property included in the Common Elements and Limited Common Elements in an amount, after deductibles, of not less than 100% of the replacement value of the insured property at the time the insurance is purchased and at each renewal date (excluding land, foundations, walks, drives and excavation costs), but with co-insurance clauses being permitted, as set forth in the Bylaws.

(b) comprehensive public liability insurance including non-owned and hired automobile liability coverage and personal injury liability coverage in an amount to be determined by the Executive Board; provided, however, in no event shall the comprehensive public liability insurance policy be an amount less than the minimum amount of One Million Dollars (\$1,000,000.00) per occurrence.

(c) worker's compensation and employer's liability insurance as necessary to comply with applicable laws;

(d) directors' and officers' liability insurance, if available, covering all of the directors and officers of the Association;

(e) casualty insurance in amounts and coverages sufficient to insure the Common Elements and Limited Common Elements at replacement value; and

(f) such other insurance which the Executive Board considers appropriate to protect the Association.

If such insurance is not reasonably available, and the Executive Board determines that any insurance described in this Article will not be provided by the Association, the Executive Board shall cause notice of that fact to be hand-delivered or sent, postage prepaid, by United States mail to all Unit Owners at their respective last known addresses. Such insurance shall cover liabilities of the Association, its Directors, officers, employees, agents and Members arising in connection with the ownership, operation, maintenance, occupancy or use of the Common Elements and any other area the Association is required to maintain, repair or replace.

Section 10.2 Unit Owner's Insurance. Each Unit Owner shall obtain and pay for (a) property insurance for the personal property in such Unit Owner's Unit, and any additions, alterations, improvements and betterments to such Unit Owner's Unit and (b) such Unit Owner's personal liability to the extent not covered by the policies of liability insurance obtained by the Association for the benefit of all of the Unit Owners.

Section 10.3 The insurance policies purchased by the Association, to the extent reasonably available, shall contain the following provisions, unless reasonably waived by the Board:

(a) Each Unit Owner shall be an insured under the policy with respect to liability arising out of his ownership of an undivided interest in the Common Elements and Limited Common Elements and/or their membership in the Association.

(b) There shall be no subrogation with respect to the Association, its agents, servants, and employees, or with respect to the Unit Owners and their respective agents, servants and employees. Each of the foregoing parties hereby waives, releases and discharges any right of subrogation against the other for any loss arising out of damage to or destruction of all or any portion of the Property or contents thereof when such loss is caused by any perils included within either party's insurance provisions.

(c) No act or omission by any Unit Owner, unless acting within the scope of their authority on behalf of the Association, shall void the policy or be a condition to recovery on the policy.

(d) The coverage afforded by such policy shall not be brought into contribution or proration with any insurance which may be purchased separately by Unit Owners or their mortgagees or beneficiaries under deeds of trust.

(e) A "severability of interest" endorsement which shall preclude the insurer from denying the claim of a Unit Owner because of the negligent acts of the Association or other Unit Owners.

(f) Statement of the name of the insured as Antler View Office Owners Association, Inc., for the use and benefit of the individual Unit Owners (designated by name if required by the insurer).

(g) A "Guaranteed Replacement Cost Endorsement" (under which the insurer agrees to replace the insurable property regardless of the cost), and if the policy includes a coinsurance clause, an "Agreed Amount Endorsement" (which waives the requirement for coinsurance), or a "Replacement Cost Endorsement" (under which the insurer agrees to pay up to 100% of the property's insurable replacement cost, but no more) and, if the policy includes a coinsurance clause, an "Agreed Amount Endorsement" (which waives the requirement for coinsurance).

(h) An "Inflation Guard Endorsement".

It shall be the duty of the Board at least annually to conduct an insurance review to determine if the policy in force is adequate to meet the need of the Association and to satisfy the requirement of this Declaration and the Act. Such responsibility may be performed and shall be deemed reasonably performed, by the Board's managing agent requesting the Association's insurance agent to verify that the insurance policies in existence meet the needs of the Association as set forth herein and satisfies the requirements of this Declaration and the Act. In all events, each Unit Owner shall have the right to obtain additional coverage for such improvements, or betterments or personal property within the Unit at its own expense. Each policy may contain reasonable deductibles and the amount thereof shall be added to the face amount of the policies in determining whether the insurance equals at least full replacement cost.

Section 10.4 Certificate of Insurance. An insurer that has issued an insurance policy under this Article shall issue certificates or a memorandum of insurance to the Association and,

upon request, to any Unit Owner, mortgagee or beneficiary under a deed of trust. Any insurance obtained pursuant to this Article may not be canceled until thirty (30) days after notice of the proposed cancellation has been mailed to the Association and each Unit Owner.

Section 10.5 Payment of Premiums. Premiums for all insurance obtained by the Association pursuant to this Article shall be Common Expenses and shall be paid for by the Association.

Section 10.6 Insurance Obtained by Owners. The issuance of insurance policies to the Association pursuant to this Article shall not prevent a Unit Owner from obtaining insurance for its own benefit and at its own expense covering their Unit, other than the original improvements and betterments installed or constructed within the Unit by the Declarant, personal property and providing personal liability coverage. Unit Owners shall, for its own benefit and interest, and at its own expense, insure all additions, alterations, improvements and betterments installed or constructed within any Unit, whether constructed by Declarant or Unit Owner, and shall also separately insure their personal property and liability coverage.

ARTICLE XI INDEMNIFICATION

To the full extent permitted by law, each officer, Director and member of the Executive Board of the Association shall be and are hereby indemnified by the Unit Owners and the Association against all expenses and liabilities, including attorneys' fees reasonably incurred by or imposed upon them in any proceeding to which they may be a party, or in which they may become involved, by reason of their being or having been an officer or member of the Executive Board of the Association, or any settlement thereof, whether or not they are an officer or a member of the Executive Board of the Association at the time such expenses are incurred, except in such cases where such officer or member of the Executive Board is adjudged guilty of willful misfeasance or malfeasance in the performance of his or her duties; provided that in the event of a settlement, the indemnification shall apply only when the Executive Board approves such settlement and reimbursement as being in the best interests of the Association.

ARTICLE XII ARCHITECTURAL CONTROL

Section 12.1 Architectural Control Committee.

(a) The members of the Architectural Control Committee shall be the Members of the Executive Board. Each member of the Architectural Control Committee shall serve so long as the member is a member of the Executive Board. In the event of the death or resignation of any member of the Architectural Control Committee, the remaining members may appoint a successor.

(b) All decisions of the Architectural Control Committee shall be by a majority vote of those members of the Architectural Control Committee present at a meeting at which a quorum is present. A majority of the members of the Architectural Control Committee shall constitute a quorum.

(c) The members of the Architectural Control Committee shall not be entitled to any compensation for services performed pursuant to this Declaration.

(d) The Architectural Control Committee may delegate the responsibility for reviewing any application submitted to the Architectural Control Committee to a professional architect, landscape architect, engineer, or other professional person who is qualified to review the issues raised in the application. The Architectural Control Committee shall also have the power to require that the applicant pay the fees reasonably incurred by the Architectural Control Committee in retaining such professional to review the application submitted.

(e) No member of the Architectural Control Committee shall be liable to the Association or to any Unit Owner or Member for any loss, damage, or injury arising out of or in connection with the performance of the duties of the Architectural Control Committee under this Declaration, unless such action constitutes willful misconduct or bad faith on the part of the Architectural Control Committee. Review and consideration of any application submitted to the Architectural Control Committee shall be pursuant to this Declaration, and any approval granted shall not be considered approval of the structural safety or integrity of the improvements to be constructed or conformance of such improvements with building codes, zoning resolutions, subdivision regulations, or other governmental rules and regulations applicable to the Condominium.

Section 12.2 Control. No complete or partial construction, alteration, addition, modification or reconstruction of the Building exterior, or any fences, common signs, gates, awnings, loading docks, walls, structures, or other improvements within the Condominium shall begin or continue until the relative plans and specifications are approved by the Architectural Control Committee; provided, however, any improvement or construction undertaken or planned by the Declarant pursuant to the Development Rights or Special Declarant Rights reserved by Declarant shall not be subject to regulation by the Architectural Control Committee.

Section 12.3 Purpose. The Architectural Control Committee is established for the purpose of maintaining within the Condominium a consistent and harmonious general character of development and a style and nature of building, design and individual appeal consistent with the business environment and features of the Condominium.

Section 12.4 Review of Plans and Specifications. The Architectural Control Committee shall consider and act upon any and all requests submitted for its approval. The Architectural Control Committee shall approve plans and specifications submitted to it only if it determines that the construction, alteration, and additions contemplated thereby, and in the location as indicated, will comply with this Declaration; will serve to preserve and enhance the values of Units within the Condominium; will be consistent with the spirit and intent of this Declaration; and will maintain a harmonious relationship among structures, vegetation and topography within the Condominium. The Architecture Control Committee shall consider the quality of workmanship, type of materials, and harmony of exterior design and appearance with other Units. If the Architectural Control Committee fails to approve or disapprove the plans and specifications submitted to it by a Unit Owner within thirty (30) days after complete submission of all required documents, the plans shall be resubmitted to the Architectural Control Committee by certified mail, return receipt requested, and if the Architectural Control Committee fails to Approve or disapprove any plans within fifteen (15) days after such resubmission, the plans shall be deemed to have been approved, as submitted, and no further action shall be required; provided however that no building or other structure shall be erected or allowed to remain on any Unit which violates or is inconsistent with any of the covenants or restrictions contained in this Declaration. The issuance of a building permit or license for the construction of

improvements inconsistent with this Declaration shall not prevent the Association or any Unit Owner from enforcing the provisions of this Declaration.

Section 12.5 Submission. Each application for approval shall include two (2) complete copies of the relevant plans.

Section 12.6 Rules and Guidelines. The Architectural Control Committee may issue rules setting forth procedures for the submission of plans for approval and may also issue guidelines setting forth the criteria that the Architectural Control Committee will use in considering plans submitted to it for approval.

Section 12.7 No Waiver of Future Approval. The approval by the Architectural Control Committee of any proposals or plans and specifications for any work to be done on a Unit shall not be deemed to constitute a waiver of any right to withhold approval to any similar proposals, plans, specifications, drawings, or other matters subsequently or additionally submitted for approval by the same Unit Owner or by another Unit Owner.

Section 12.8 Variances. The Architectural Control Committee may authorize variances from compliance with any provisions of this Declaration, including restrictions upon height, size, floor area or placement of structures or similar restrictions, when circumstances such as scenic view obstructions, natural obstructions, hardships, aesthetics, or environmental considerations may require. Such variances must be evidenced in writing and shall become effective when signed by at least a majority of the members of the Architectural Control Committee. If any such variance is granted, no violation of the provisions of this Declaration shall be deemed to have occurred with respect to the matter for which the variance was granted; provided however that the granting of the variance shall not operate to waive any of the provisions of this Declaration for any purpose except as to the particular property and the particular provisions hereof covered by the variance, nor shall the granting of a variance affect in any way the Unit Owner's obligation to comply with all governmental laws and regulations affecting the property concerned, including but not limited to zoning ordinances and setback lines or requirements imposed by any governmental authority having jurisdiction.

ARTICLE XIII RESTRICTIVE COVENANTS AND OBLIGATIONS

Section 13.1 No Improvements on Exterior of Unit. Except for those improvements erected or installed by the Declarant, no exterior additions to, exterior alterations of, or exterior decoration of a Unit shall be commenced, erected or maintained without the prior written approval of the Architectural Control Committee.

Section 13.2 Noxious or Offensive Trades Prohibited. No noxious or offensive trades, services or activities shall be conducted within the Condominium or within any of the Units, nor shall anything be done thereon which may become an annoyance or nuisance to the Unit Owners of other Units within the Condominium, including, without limitation, allowing or creating unsightliness or excessive emission of fumes, odors, glare, vibration, electromagnetic disturbance, gases, radiation, dust, liquid waste, smoke or noise.

Section 13.3 Temporary Modular and Storage Structures. No temporary structures, including but not limited to, trailers, mobile homes, converted trailers, campers, shacks, basements, tents, garages, or accessory buildings, shall be used on any Unit or Common

Elements, without the approval of the Architectural Control Committee. No modular constructed structures are allowed. No garages are allowed.

Section 13.4 Additional Prohibitions. No window air conditioners, display or storage racks or fences are allowed.

Section 13.5 Utilities. All utilities installed within the Condominium must be underground unless otherwise approved by the Architectural Control Committee.

Section 13.6 Intentionally Deleted.

Section 13.7 Storage of Vehicles. Overnight storage of vehicles of any kind is not allowed.

Section 13.8 Maintenance of Units and Improvements. Each Unit Owner shall keep or cause to be kept his or her Unit in good repair. Rubbish, refuse, garbage, and other solid, semi-solid, and liquid waste shall be kept within sealed containers, shall not be allowed to accumulate on any Unit, and shall be disposed of in a sanitary manner. No Unit shall be used or maintained as a dumping ground for any materials. All containers shall be kept in a neat, clean, and sanitary condition and shall be stored inside. No trash, litter or junk shall be permitted to remain exposed upon any Unit or visible from adjacent streets or other Units. Burning of trash on a Unit shall be prohibited. No lumber or other building materials shall be stored or permitted to remain on any Unit unless screened from view from other Units and except for reasonable storage during construction.

Section 13.9 Animals. No animals of any kind, including pets, shall be allowed on the Common Elements or in any Unit at any time.

Section 13.10 Nuisance. Nothing shall be done or permitted on any Unit which is or may become a nuisance. No obnoxious or offensive activities shall be conducted on any Unit. Recreational use of all-terrain vehicles, motorcycles, snowmobiles and similar vehicles or equipment on a Unit or on the Common Elements is prohibited.

Section 13.11 Damage or Destruction of Improvements. If any Unit or structure constructed on a Unit is damaged, either in whole or in part, by fire or other casualty, said structure shall be rebuilt in a timely manner, not to exceed six (6) months from the date of damage.

Section 13.12 Signs. No sign of any character shall be displayed or placed upon any Unit except such signs as are first approved by the Architectural Control Committee.

Section 13.13 Color. All improvements constructed on any Unit shall be stained or painted colors authorized and approved by the Architectural Control Committee.

Section 13.14 Nighttime Lighting. Units may be continuously illuminated during the period of sunset to sunrise with lights as necessary for security.

Section 13.15 Further Subdivision. No Unit may be further subdivided without the approval of the Executive Board, which approval shall be within its sole discretion. This provision shall not be construed to prohibit or prevent the dedication or conveyance of any

portion of a Unit as an easement for public utilities. Further, this provision shall not be construed to limit Declarant's right to further subdivide Units.

Section 13.16 Discharge of Weapons. No person shall discharge, fire, or shoot any gun, pistol, revolver, rifle, shotgun, crossbow, bow and arrow, sling shot, pellet gun, or other firearm or weapon whatsoever within any portion of the Condominium, including a Unit Owner's own Unit. Notwithstanding the foregoing, the discharge of firearms or weapons by any member of any law enforcement office in the course of such member's official duty shall not be deemed a violation of this provision.

Section 13.17 Disturbing the Peace. No Person shall disturb, tend to disturb or aid in disturbing the peace of others by violent, tumultuous, offensive, disorderly or obstreperous conduct and no Unit Owner shall knowingly permit such conduct.

Section 13.18 Drainage. No Unit Owner shall modify or change the topography or contour of any drainage areas or easements, including swales, existing upon any portion of the Condominium.

Section 13.19 Parking. Unit Owners, employees, customers, guests and invitees shall use their reasonable efforts to park only in the parking spaces that are in front of the respective Unit. The Declarant or the Association may tow vehicles, assess fines, establish Rules and Regulations and take any other reasonable action necessary to enforce the provisions of this Article, subject to compliance with applicable law. The remedies in this Article shall be cumulative with other remedies and/or rights set forth in other Articles of this Declaration.

Section 13.20 General Prohibition. No use shall be made of a Unit Owner's Unit which will in any manner violate the statutes, ordinances, rules and regulations of any governmental authority having jurisdiction over the use of said Unit Owner's Unit.

ARTICLE XIV DAMAGE, DESTRUCTION, CONDEMNATION AND RESTORATION OF BUILDINGS

Section 14.1 Sufficient Insurance. In the event the improvements forming a part of the Property, or any portion thereof, including any Units, shall suffer damage or destruction from any cause and the proceeds of any policy or policies insuring against such loss or damage, and payable by reason thereof, plus capital reserves, shall be sufficient to pay the cost of repair, restoration or reconstruction, then such restoration, repair, replacement or reconstruction shall be undertaken and the insurance proceeds and, if necessary, the capital reserve shall be applied by the Executive Board or the payee of such insurance proceeds in payment therefor; provided, however, that in the event within one hundred eighty (180) days after such damage or destruction, the Unit Owners shall elect either to sell the Property or to withdraw the Property from the provisions of this Declaration and from the provisions of the Act as therein provided, then such restoration, repair, replacement or reconstruction shall not be undertaken. In the event such restoration, repair, replacement or reconstruction is not undertaken, the net proceeds of insurance policies shall be divided by the Executive Board or the payee of such insurance proceeds among all Unit Owners according to each Unit Owner's Allocated Interest in the Common Elements as set forth in Exhibit "C," after first paying from the share of each Unit Owner the amount of any unpaid liens on such Unit Owner's Unit, in the order of the priority of such liens.

Section 14.2 Insufficient Insurance.

(a) If the insurance proceeds and any capital reserve are insufficient to reconstruct the Buildings and the Unit Owners and all other parties in interest do not voluntarily make provision for reconstruction of the Building(s) within one hundred eighty (180) days from the date of damage or destruction, then the provisions of the Act and this Section 14.2 shall apply.

(b) In the case of damage or other destruction in which fewer than one half ($\frac{1}{2}$) of the Units are rendered uninhabitable, upon the affirmative vote of eighty percent (80%) of the voting Members at a meeting called for that purpose, the affected Building(s) or other portion of the Property shall be reconstructed. The meeting shall be held within thirty (30) days following the final adjustment of insurance claims, if any; otherwise, such meeting shall be held within ninety (90) days of the occurrence of the damage or other destruction. At such meeting the Executive Board or its representatives shall present to the members present an estimate of the cost of repair or reconstruction and the estimated amount of necessary assessments against each Unit Owner.

(c) In the case of damage or other destruction, upon the unanimous affirmative vote of the voting Members at a meeting called for that purpose, any portion of the Property affected by such damage or destruction may be withdrawn from the provisions of this Declaration and from the provisions of the Act as therein provided. Upon the withdrawal of any Unit or portion thereof, the percentage of interest in the Common Elements appurtenant to such Unit or portion thereof shall be reallocated among the remaining Units on the basis of the percentage of interest of each remaining Unit. If only a portion of a Unit is withdrawn, the percentage of interest appurtenant to that Unit shall be reduced accordingly, upon the basis of diminution in market value of the Unit, as determined by the Executive Board. The payment of just compensation or the allocation of any insurance or other proceeds to any withdrawing or remaining Unit Owner shall be on an equitable basis, which need not be a Unit's percentage interest. Any insurance or other proceeds available in connection with the withdrawal of any portion of the Common Elements, not necessarily including the Limited Common Elements, shall be allocated on the basis of each Unit Owner's percentage interest therein. Any proceeds available from the withdrawal of any Limited Common Elements will be distributed in accordance with the interest of those entitled to their use. Upon the withdrawal of any Unit or portion thereof, the responsibility for the payment of assessments on such Unit or portion thereof by the Unit Owner shall cease.

Section 14.3 Eminent Domain. In the event any portion of the Property is taken by condemnation or eminent domain proceedings, provision for withdrawal of the portions so taken from the provisions of this Declaration and from the provisions of the Act as therein provided may be made by the Executive Board. Upon the withdrawal of any Unit or portion thereof due to eminent domain, the percentage of interest in the Common Elements appurtenant to such Unit or portion so withdrawn shall be reallocated among the remaining Units on the basis of the percentage of interest of each remaining Unit. If only a portion of a Unit is withdrawn, the percentage of interest appurtenant to that Unit shall be reduced accordingly, upon the basis of diminution in market value of the Unit, as determined by the Executive Board, and the other Unit Owners' percentages shall be correspondingly increased. The allocation of any condemnation award or other proceeds to any withdrawing or remaining Unit Owner shall be on an equitable basis, which need not be a Unit's percentage interest. Any condemnation award or other

proceeds available in connection with the withdrawal of any portion of the Common Elements, not necessarily including the Limited Common Elements, shall be allocated on the basis of each Unit Owner's percentage interest therein. Proceeds available from the withdrawal of any Limited Common Element will be distributed in accordance with the interests of those entitled to their use. Upon the withdrawal of any Unit or portion thereof, the responsibility for the payment of assessments on such Unit or portion thereof by the Unit Owner shall cease. The Association shall represent the Unit Owners in any condemnation proceedings or in negotiations, settlements and agreements with the condemning authority for the acquisition of the Common Elements or any part thereof, and the Association is hereby appointed as attorney in fact for each Unit Owner to represent the Unit Owners in any condemnation proceedings or in negotiations, settlements and agreements with the condemning authority relating to such acquisitions of the Common Elements or any part thereof. In the event of the total taking of the Property by eminent domain, the condemnation award available in that connection shall be divided by the Association among all Unit Owners according to each Unit Owner's percentage of ownership in the Common Elements as set forth in Exhibit "C," after first paying from the share of each Unit Owner the amount of any unpaid liens on such Unit Owner's Unit, in the order of the priority of such liens.

Section 14.4 Repair, Restoration or Reconstruction of the Improvements. As used in this Article, "restoration, repair, replacement or reconstruction" of improvements means restoring the improvements to substantially the same condition in which they existed prior to the damage or destruction, with each Unit and Common Element having the same vertical and horizontal boundaries as before, unless, if allowed by the Act, other action is approved by Unit Owners and their respective mortgagees representing at least eighty percent (80%) of the votes in the Association. Any repair, restoration or reconstruction shall be in accordance with law and this Declaration and shall be made subject to the rights of the mortgagees.

ARTICLE XV REMEDIES

Section 15.1 Violations. Upon the occurrence of any one or more of the following events, the Executive Board shall have the rights and remedies set forth below:

(a) Failure by a Unit Owner to pay when due any sums required to be paid by such Unit Owner pursuant to the provisions of this Declaration, for thirty (30) days after written notice of such nonpayment shall have been given such Unit Owner, provided that such defaulting Unit Owner shall not be entitled to written notice and opportunity to cure such failure if such Unit Owner has been given two (2) or more notices pursuant to this Article XV, Paragraph 1(a) during the twelve (12) month period immediately preceding the first day of such failure. If the assessment is not paid within thirty (30) days after the due date, then (i) the amount of the assessment shall bear interest from the date of delinquency at a rate reasonably determined by the Executive Board, and (ii) in addition to such interest, the Association shall charge a delinquent Unit Owner a late fee of five percent (5%) of the assessment for each month or portion thereof that such amount remains delinquent, such late charge to cover the Association's administrative costs in monitoring and collecting such amount. Such assessments, interest, late charges and all costs of collection shall be a continuing lien upon the Unit against each such assessment was made.

(b) Violation or breach by a Unit Owner or an occupant of any provision, covenant or restriction of the Act, this Declaration, the Bylaws, contractual obligation to

the Executive Board or Association undertaken by such Unit Owner, or rules and regulations promulgated by the Executive Board, and continuation of such violation or breach for thirty (30) days after written notice thereof shall have been given such Unit Owner, provided that such defaulting Unit Owner shall not be entitled to written notice and opportunity to correct such violation or breach if such Unit Owner has been given two (2) or more notices pursuant to this Article XV, Paragraph 1(b) during the twelve (12) month period immediately preceding the first day of such violation or breach.

Section 15.2 Remedies. Upon the occurrence of any one or more of the events described in Paragraph 1 above, the Executive Board shall have the following rights and remedies:

(a) For a violation or breach described in Paragraph 1(b) above, the Executive Board shall have the right: (i) to enter upon that part of the Property where such violation or breach exists and summarily abate and remove or do whatever else may be necessary to correct, at the expense of the defaulting Unit Owner, any such violation or breach or the cause of such violation or breach, and the Declarant or its successors or assigns, or the Executive Board, or its agents, shall not thereby be deemed guilty in any manner of trespass, or (ii) to enjoin, abate or remedy by a proceeding at law or in equity the continuance of any such violation or breach; provided, however, that no summary abatement shall be undertaken in connection with any alteration or demolition of improvements until judicial proceedings are instituted.

(b) Upon the occurrence of one of the events described in Paragraph 1(a) above, including, without limitation, failure by a Unit Owner to pay such Unit Owner's Allocated Interest of Common Expenses or user charges, the Executive Board shall have a lien on the interest of the defaulting Unit Owner in such Unit Owner's Unit Ownership in the amount of any sums due from such Unit Owner; provided, however, that such lien shall be subordinate to the lien of any recorded mortgage encumbering the interest of such Unit Owner. Except as hereinafter provided, the lien provided for in this Paragraph 2(b) shall not be affected by any transfer of title to the Unit Ownership. Where title to the Unit Ownership is transferred pursuant to a decree of foreclosure or by deed in lieu of foreclosure, such transfer of title shall, to the extent permitted by law, extinguish the lien described in this Paragraph 2(b) for any sums which became due prior to (i) the date of the transfer of title or (ii) the date on which the transferee comes into possession of the Unit Ownership, whichever occurs first. However, the transferee of a Unit Ownership shall be liable for such Unit Owner's share of any sums with respect to which a lien against such Unit Owner's Unit Ownership has been extinguished pursuant to the preceding sentence which are reallocated among the Unit Owners pursuant to a subsequently adopted annual revised or special assessment, and nonpayment thereof by such transferee shall result in a lien against the transferee's Unit Ownership as provided in this Paragraph 2(b).

(c) The Executive Board shall have the power to issue to the defaulting Unit Owner a ten (10) day notice in writing to terminate the right of such defaulting Unit Owner to continue as a Unit Owner and to continue to occupy, use, or control such Unit Owner's Unit Ownership and thereupon an action may be filed by the Executive Board against the defaulting Unit Owner for a decree declaring the termination of the defaulting Unit Owner's right to occupy, use or control the Unit owned by him and, subject to the limitations of applicable law, ordering that all the right, title and interest of such defaulting Unit Owner in the Property shall be sold at a judicial sale, upon such notice and terms as

the court shall determine, except that the court shall enjoin and restrain the defaulting Unit Owner from reacquiring such Unit Owner's interest in the Unit Ownership at such judicial sale. It shall be a condition of any such sale, and the decree shall so provide, that the Purchaser shall take the interest in the Unit Ownership sold subject to this Declaration. The proceeds of any such judicial sale shall first be paid to discharge court costs, court reporter charges, reasonable attorneys' fees, and all other expenses of the proceeding and sale, and all such items shall be taxed against the defaulting Unit Owner in such decree. Any balance of proceeds, after satisfaction of such charges and any unpaid assessments or other sums due hereunder or any liens, shall be paid to the defaulting Unit Owner. Upon the confirmation of such sale, the Purchaser at such sale shall be entitled to a deed to the Unit Ownership and to immediate possession of the Unit sold and may apply to the court for a writ of assistance for the purpose of acquiring such possession.

(d) In addition to or in conjunction with the remedies set forth above, the Executive Board or its agents shall have the right to bring an action at law or in equity against the Unit Owner or Occupant as permitted by law, including, without limitation, an action (i) to foreclose a lien against the Unit Ownership, (ii) for damages, injunctive relief or specific performance, (iii) for judgment or for the payment of money and the collection thereof, (iv) for any combination of the remedies set forth in this Article or (v) for any other relief which the Executive Board may deem necessary or appropriate. Any and all rights and remedies provided for in the Act, this Declaration, the Bylaws, any contractual obligation to the Executive Board or Association undertaken by such Unit Owner, or rules and regulations promulgated by the Executive Board may be exercised at any time and from time to time cumulatively or otherwise by the Executive Board in its discretion. The failure of the Executive Board to exercise any such rights or remedies to enforce any provisions of this Declaration, the Bylaws or rules and regulations of the Executive Board shall in no event be deemed a waiver of the right to do so thereafter.

(e) All expenses incurred by the Executive Board in connection with any actions, proceedings or self help in connection with the exercise of its rights and remedies under this Article, including, without limitation, court costs, reasonable attorneys' fees and all other fees and expenses, and all damages, together with interest thereon at the rate of eighteen percent (18%) per annum (or such lesser rate charged by law should eighteen percent (18%) be held to be in excess of the maximum legal rate allowable by law), shall be charged to and assessed against the defaulting Unit Owner, and shall be added to and deemed part of such Unit Owner's respective share of the Common Expenses, and the Executive Board shall have a lien for all of the same upon the Unit Ownership of such defaulting Unit Owner and upon all of such Unit Owner's additions and improvements thereto.

Section 15.3 Enforcement by Unit Owners. Any aggrieved Unit Owner (including Declarant) may enforce the provisions of this Declaration, the Bylaws or any rules and regulations promulgated by the Executive Board by an action at law or in equity against the defaulting Association or against the defaulting Unit Owner or Occupant upon a violation or breach described in Paragraph 1(b) above against any person or persons either to restrain such violation or breach or to recover damages.

ARTICLE XVI GENERAL PROVISIONS

Section 16.1 Certain Rights of the Declarant. Until the Transfer Date, the rights, titles, powers, privileges, trusts, duties and obligations vested in or imposed upon the Executive Board and the Architectural Control Committee in the Act or in this Declaration shall be held and performed by the Declarant, which may be exercised by the designation of an initial Executive Board in accordance with the terms hereof and in accordance with the procedure set forth in the Bylaws. If the initial Executive Board shall not be elected by the Unit Owners at the time established by the Bylaws, the Declarant shall continue in the aforesaid office for a period of thirty (30) days after written notice of its resignation is sent to all of the Unit Owners entitled to vote at such election. In exercising such rights, and the other rights reserved by the Declarant pursuant to this Declaration, the Declarant shall not be under any disability which would otherwise be imposed by law by reason of the Declarant's interest in the subject matter of any transaction; provided, however, that any such transaction shall have been entered into in good faith. Prior to the Transfer Date, notwithstanding any provision herein to the contrary, the Declarant shall have the following rights and privileges, which are hereby reserved only to itself and to its successors and assigns and their respective agents:

(a) The Declarant may exercise any of the "development rights" or "special declarant rights" described in Section 76-826 of the Act (collectively, the "Special Declarant Rights").

(b) The Declarant may (i) relocate the boundaries of any Unit or Units, (ii) further subdivide any one or more of the Units into additional Units, Common Elements or both; and (iii) create additional Units, Common Elements, and/or Limited Common Elements within all or any part of the Property and/or Additional Property, which Additional Property may be designated on the Plat and Plans as "Additional Property" or as "Reserved" or "Reserved for Future Development"; and to add property to the Condominium, provided, however, that the maximum number of additional Units which the Declarant reserves the right to create shall not exceed twenty-six (26) Units. Declarant shall have the unilateral right to reallocate percentages of undivided interests in the Common Elements, liability for payment of Common Expenses, allocation of Limited Common Elements, and adjust the total number of voting interests in the Association (by adding or eliminating a Unit or Units), as to be done in accordance with this Declaration and the Act. Upon the addition of any Units to the Condominium, the Allocated Interests shall be reallocated among all units pursuant to the terms of this Declaration and the formula set forth herein. The Declarant shall cause such relocation or subdivision by its adoption, execution or recordation of an amendment to this Declaration by recording such certificates and plans as required by the Act. Such amendment shall be adopted by the Declarant pursuant to the terms hereof without the consent of any Unit Owners. From time to time, as the Declarant shall file permitted amendments to this Declaration, each then owner and each Person or entity thereafter becoming a Unit Owner and its successors in title shall, upon the reallocation of such Common Elements or Limited Common Elements automatically be vested with the appropriate undivided percentage interest in such Common Elements and Limited Common Elements. The consent of Unit Owners within the Condominium shall not be required for the exercise of any of the foregoing Development Rights and/or Special Declarant Rights, unless otherwise required by the Act, and the Declarant may proceed with the exercise of such Development Rights and/or Special Declarant Rights at its sole option and its sole discretion.

Section 16.2 Employees: Maintenance of Common Elements. The Association shall have no employees. All maintenance of the Common Elements will be contracted to outside companies. The Executive Board may set a management fee for the managing Director to cover accounting, legal and other costs associated with management of the Association and management of the Common Elements.

Section 16.3 Record of Receipts and Expenditures. The Association shall keep detailed and accurate records in chronological order of all of its receipts and expenditures, specifying and itemizing the maintenance and repair expenses of the Common Elements and any other expenses incurred. Such records and the vouchers authorizing the payments shall be available on request for examination by the Unit Owners and others with an interest, such as prospective lenders.

Section 16.4 Conveyance and Leases. Each grantee of the Declarant, each subsequent grantee by the acceptance of a deed of conveyance, each Purchaser under a Deed to a Unit and each tenant under a lease for a Unit Ownership accepts the same subject to all restrictions, conditions, covenants, reservations, liens and charges, and the jurisdiction, rights and powers created or reserved by this Declaration, and all rights, benefits and privileges of every character hereby granted, created, reserved or declared, and all impositions and obligations hereby imposed, shall be deemed and taken to be covenants running with the land and shall bind any person having at any time an interest or estate in the Property and shall inure to the benefit of such Unit Owner in like manner as though the provisions of the Declaration were recited and stipulated at length in each and every deed of conveyance.

Section 16.5 Term of Declaration. This Declaration shall run with the land, shall be binding upon all Persons owning Units and any Persons hereafter acquiring said Units, and shall be in effect in perpetuity unless amended or terminated as provided in the Act.

Section 16.6 Amendment of Declaration. No provision of this Declaration affecting the rights, privileges and duties of the Declarant may be modified without the Declarant's prior written consent. Except as otherwise provided in the Act and this Declaration, other provisions, covenants, conditions, restrictions or equitable servitudes contained in this Declaration may be amended or repealed at any time and from time to time upon approval of the amendment or repeal by Members of the Association holding at least sixty-seven percent (67%) of the voting power of the Association present in person or by proxy at a duly constituted meeting of the Members. The approval of any such amendment or repeal shall be evidenced by the certification by the Executive Board of the Association of the vote of Members. The amendment or repeal shall be effective upon the recordation in the office of the Register of Deeds of Douglas County, Nebraska, of a certificate, executed by the President or a Vice President and the Secretary or an Assistant Secretary of the Association setting forth the amendment or repeal in full and certifying that the amendment or repeal has been approved by the Members and certified by the Executive Board as set forth above.

Section 16.7 Special Amendment. Declarant reserves the right and power to record a special amendment ("Special Amendment") to this Declaration at any time and from time to time to amend the Plat and Plans or to amend this Declaration (a) to correct clerical or typographical or similar errors in this Declaration or any Exhibit hereto or any supplement or amendment thereto, (b) to exercise any of the Special Declarant Rights (specifically the right to add the Additional Property), (c) such amendment or supplement is necessary to conform this Declaration to the Act, as amended from time to time, and (d) to relocate boundary lines of Units, subdivide or combine Unit(s) owned by Declarant pursuant to this Declaration. In

furtherance of the foregoing, a power coupled with an interest is hereby reserved and granted to the Declarant to vote in favor of, make or consent to a Special Amendment on behalf of each Unit Owner as proxy or attorney in fact, as the case may be. Each deed, mortgage, trust deed, other evidence of obligation or other instrument affecting a Unit Ownership, and the acceptance thereof, shall be deemed to be a grant and acknowledgment of, and a consent to the reservation of, the power to the Declarant to vote in favor of, make, execute and record Special Amendments. The right of the Declarant to act pursuant to rights reserved or granted under this Section shall terminate at such time as the Declarant has sold and delivered a conveyance deed for all of the Units which may be created in each phase of the Condominium (a total of twenty-six (26) Units may be created pursuant to the terms hereof).

Section 16.8 Assignments by Declarant. All rights which are specified in this Declaration to be rights of the Declarant are mortgageable, pledgeable, assignable or transferable. Any successor to, or assignee of, the rights of the Declarant hereunder (whether as the result of voluntary assignment, foreclosure, assignment in lieu of foreclosure or otherwise) shall hold or be entitled to exercise the rights of Declarant hereunder as fully as if named as such party herein. No party exercising rights as Declarant hereunder shall have or incur any liability for the acts of any other party which previously exercised or subsequently shall exercise such rights.

Section 16.9 Unit Owner's Duty to Disclose. Unit Owners are hereby required to disclose the existence and contents of this Declaration and any related documents, including Rules and Regulations to their tenants. Unit Owners are also required to inform their tenants that the tenants are obligated to conduct business and otherwise perform the duties imposed by the Declaration and any related documents, including Rules and Regulations. Nothing in this Article shall be construed to allow a tenant voting rights.

Section 16.10 Association Right to Security Interest Information. Each Unit Owner hereby authorizes any First Security Interest holding a Security Interest on such Unit Owner's Unit to furnish information to the Association concerning the status of such First Security Interest and the loan which it secures.

Section 16.11 Taxes. Each Unit Owner shall be solely responsible for payment of real property, personal property, sales and use taxes regarding the Unit Owner's Unit.

Section 16.12 Captions. The captions contained in the Bylaws are inserted only as a matter of convenience and for reference, and in no way define, limit or describe the scope of the Bylaws or the intent of any provision thereof.

Section 16.13 Waiver. No provision contained in the Bylaws is abrogated or waived by reason of any failure to enforce the same, irrespective of the number of violations or breaches which may occur.

Section 16.14 Invalidity and Severability. The invalidity of any provision of the Bylaws does not impair or affect in any manner the validity, enforceability of effect of the remainder, and if a provision is invalid, all of the other provisions of the Bylaws shall continue in full force and effect.

Section 16.15 Conflict. The Bylaws and other Association documents are intended to comply with the requirements of the Act. If there is any conflict between the Bylaws or other Association documents and the provisions of the Act the provisions of the Bylaws or other

Association documents shall control, unless such control would invalidate the Bylaws or other Association documents, in which case the Act shall control. If the Bylaws or other Association documents are silent as to a particular issue, the Act shall control. In the event of any conflict between this Declaration and any other document, this Declaration shall control.

Section 16.16 Meetings. Meetings of the Unit Owners shall be held at least once each year, or more often as determined by the Unit Owners, Executive Board or Association. Meetings shall be held in conformity with this Declaration, and with §76-866 of the Act.

Section 16.17 Controlling Law Jurisdiction and Venue. This Declaration shall be interpreted, construed and applied in accordance with the laws of the State of Nebraska. Jurisdiction and venue shall be solely vested in Douglas County, Nebraska.

[Signature page to follow]

EXHIBIT "A"

LEGAL DESCRIPTION

Lot 1, Antler View Replat 2, a Subdivision as surveyed, platted and recorded in Douglas County, Nebraska

EXHIBIT "B"
PLAT AND PLANS
(See Attached)

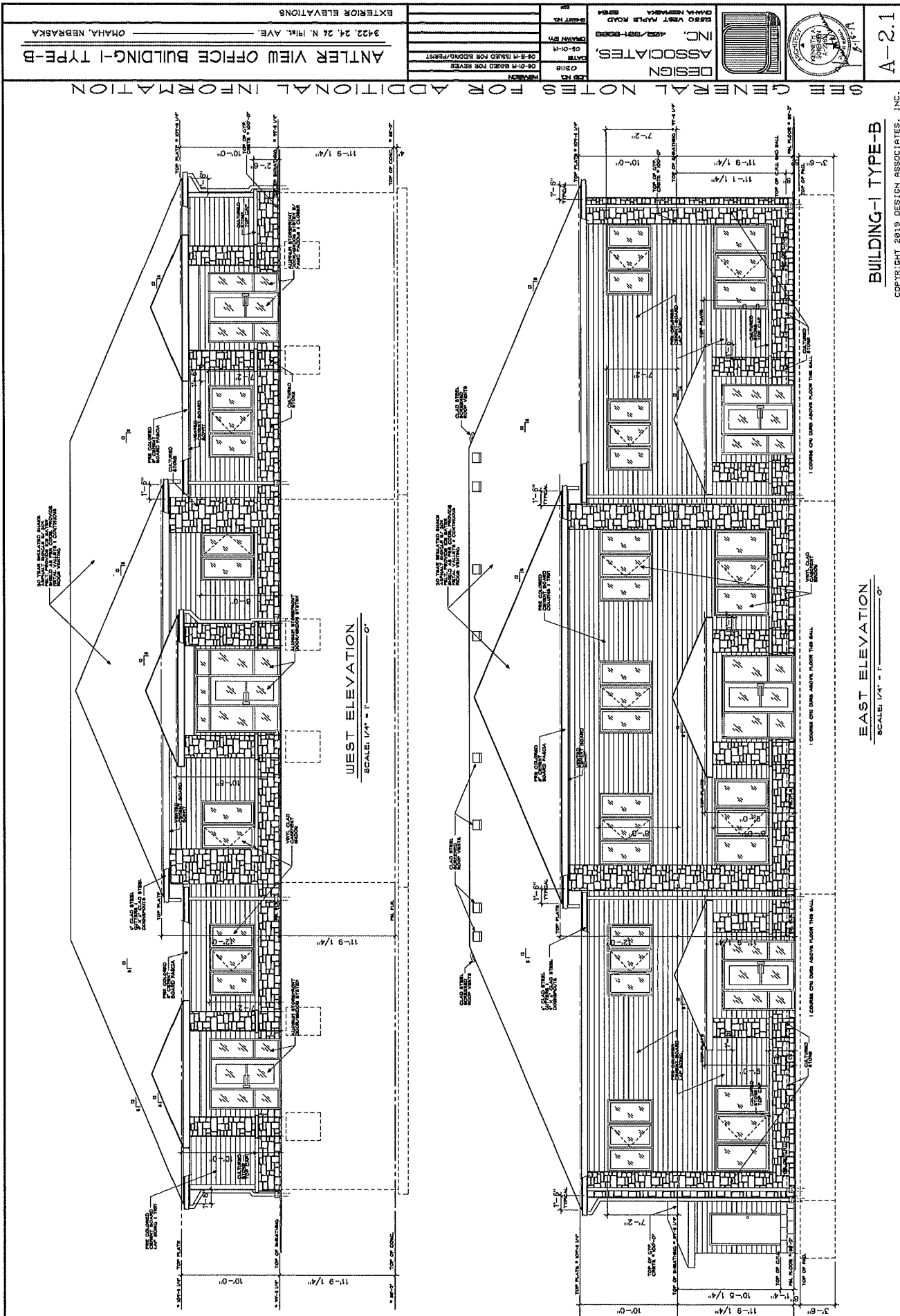

ANTLER VIEW OFFICE BUILDING-1 TYPE-B
 3422, 24, 26 N. 19th AVE. OMAHA, NEBRASKA
 EXTERIOR ELEVATIONS

DESIGN	DATE	BY
AS ASSOCIATES	02-18	...
NO. 4022/2017-0003	02-18	...
3422 WEST 19TH ROAD	02-18	...
OMAHA, NEBRASKA	02-18	...

SEE GENERAL NOTES FOR ADDITIONAL INFORMATION

DESIGN ASSOCIATES, INC.
 1747 S. BOYD AVE. SUITE 200
 OMAHA, NEBRASKA 68104
 PHONE: 402.476.1111
 FAX: 402.476.1112
 WWW.DA-NE.COM

A-2.1

WEST ELEVATION
 SCALE: 1/4" = 1'-0"

EAST ELEVATION
 SCALE: 1/4" = 1'-0"

BUILDING-1 TYPE-B

COPYRIGHT 2019 DESIGN ASSOCIATES, INC.

1747 S. BOYD AVE. SUITE 200 OMAHA, NEBRASKA 68104

<p>PLANS FOR: ANTLER VIEW OFFICE BUILDING-1 TYPE-B</p>	<p>3422, 24, 24 N. 91st. AVE. OMAHA, NEBRASKA</p>	<p>EXTERIOR ELEVATIONS</p>	<p>DESIGN ASSOCIATES, INC. 402/881-8888 2550 WEST MAPLE ROAD OMAHA, NEBRASKA 68134</p>	<p>DATE: 05-07-19 SCALE: AS SHOWN FOR REVISIONS</p>	<p>PROJECT NO.: SHEET NO.: DATE: 05-07-19</p>
---	---	----------------------------	--	---	---

SEE GENERAL NOTES FOR ADDITIONAL INFORMATION

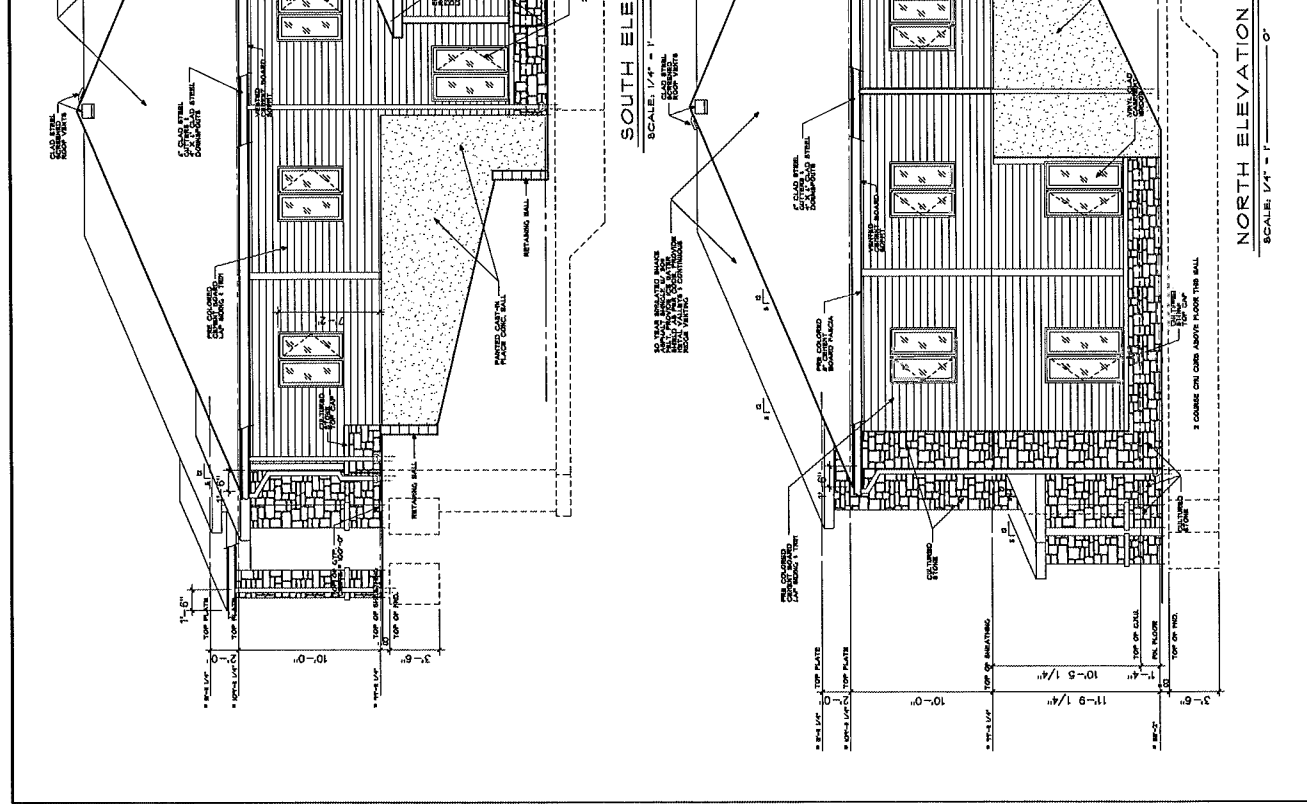
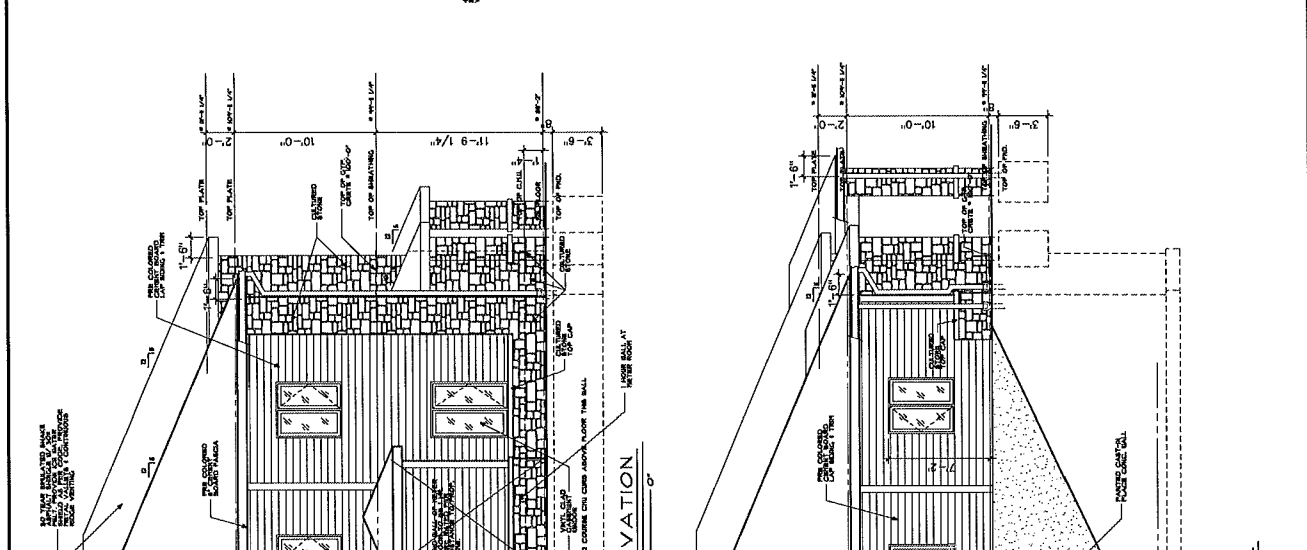
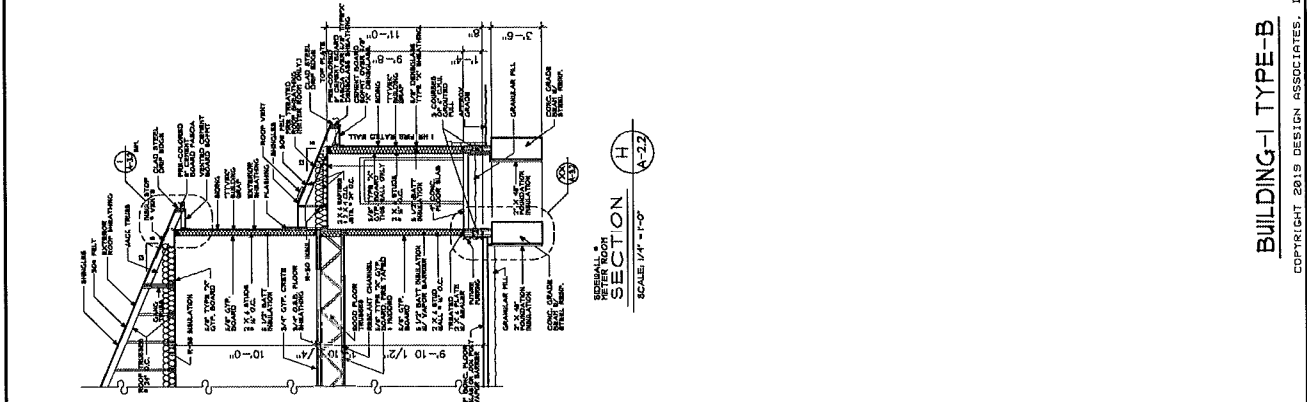

BUILDING-1 TYPE-B
 COPYRIGHT 2019 DESIGN ASSOCIATES, INC.
 BORDER DWS 831-PLAN-BUILD TYPE B PLOTTED 08-13-19

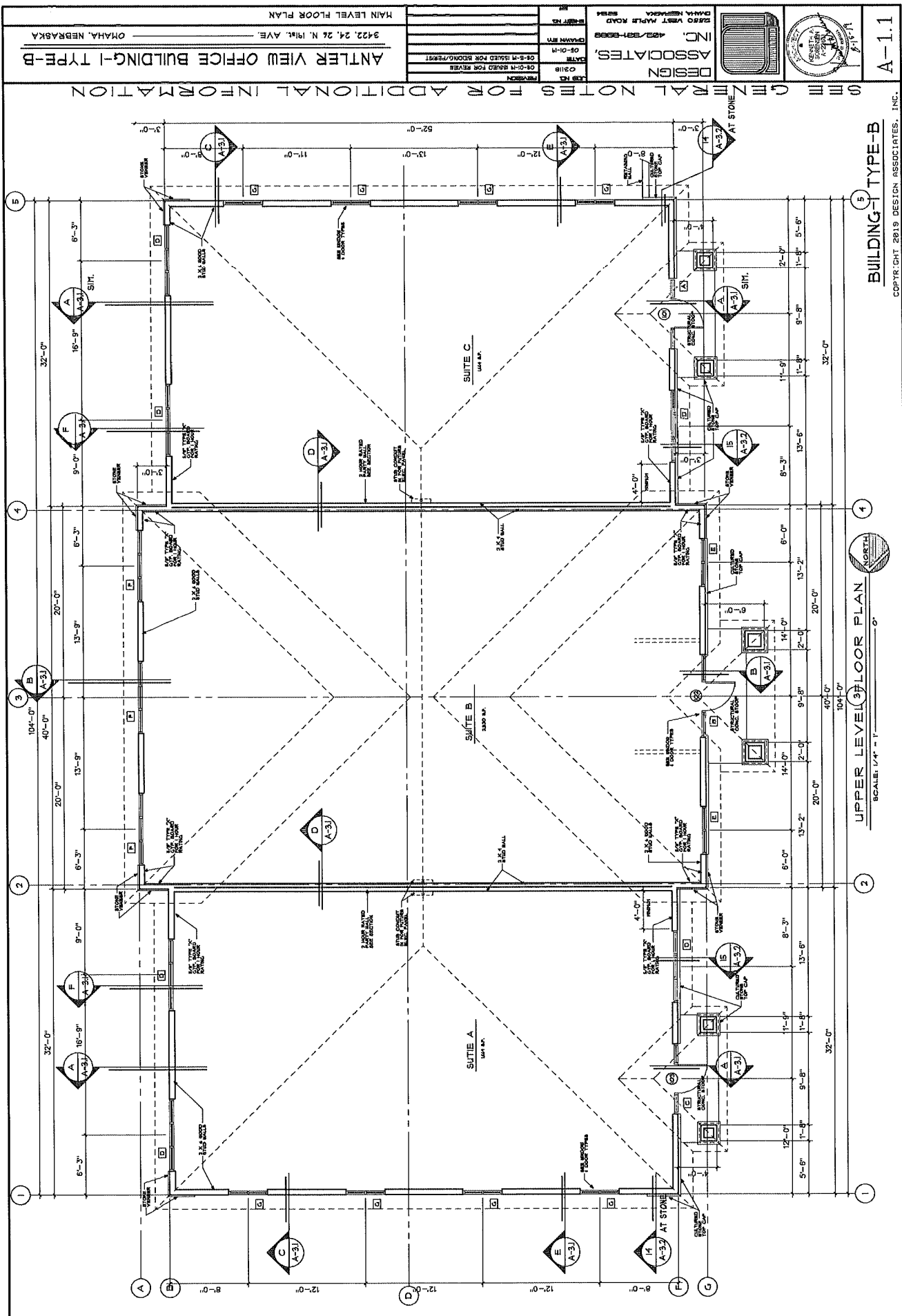

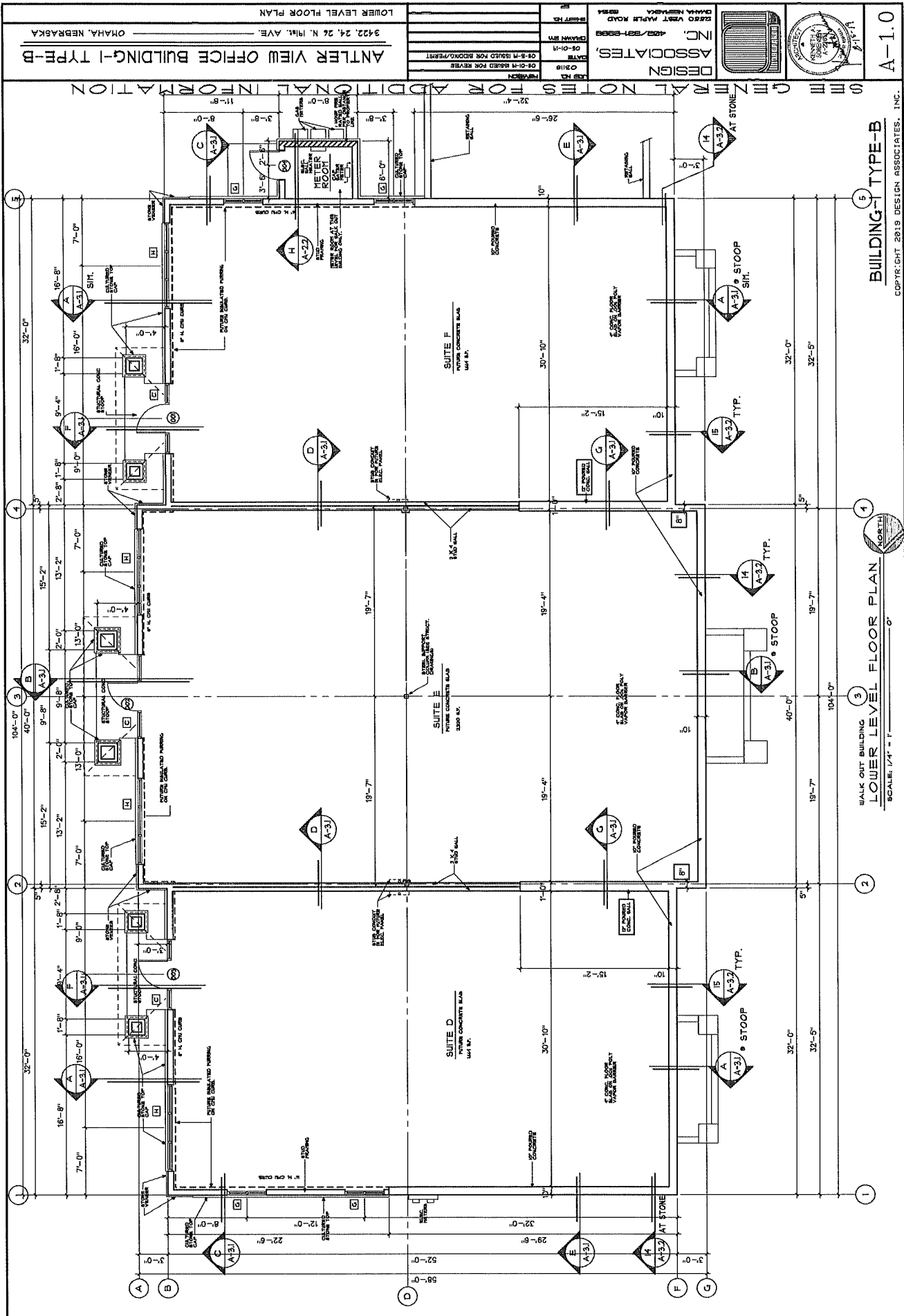

ANTLER VIEW OFFICE BUILDING-1-TYPE-B
 3423, 24, 26 N. 19th, AVE.
 OMAHA, NEBRASKA

DESIGN	ASSOCIATES
DATE	03-18-19
PROJECT NO.	19-001-19
CLIENT	OMAHA, NEBRASKA
PROJECT	ANTLER VIEW OFFICE BUILDING-1-TYPE-B

DESIGN ASSOCIATES
 402 WEST MAPLE ROAD
 OMAHA, NEBRASKA 68102

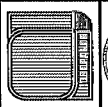

A-1.0

SEE GENERAL NOTES FOR ADDITIONAL INFORMATION

BUILDING TYPE-B

WALK OUT BUILDING

LOWER LEVEL FLOOR PLAN

SCALE: 1/4" = 1'

COPYRIGHT 2019 DESIGN ASSOCIATES, INC.

1/4" BORDER DWS 031-PLAN-BUILD-1 TYPE B PLOTTED 08-13-19

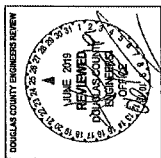

CITY OF OMAHA, NEBRASKA
 ADMINISTRATIVE SUBDIVISION
LOTS 1 THRU 4 INCLUSIVE, ANTLER VIEW REPLAT 2
 BEING A REPLATING OF ALL OF LOT 15 AND LOT 16, ANTLER VIEW, A SUBDIVISION LOCATED IN PART OF NW1/4 OF
 THE NW1/4 OF SECTION 8, TOWNSHIP 15 NORTH, RANGE 11 EAST OF THE 6TH P.M., DOUGLAS COUNTY, NEBRASKA.

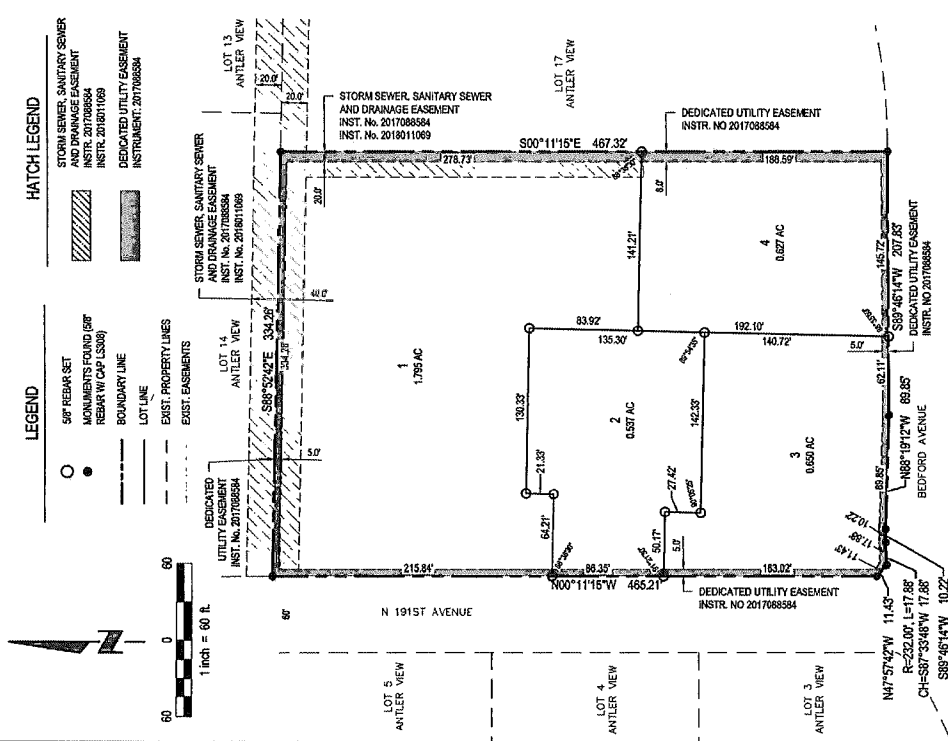

LEGEND

- 5/8" REBAR SET MONUMENTS FOUND (SPT REBAR W/ CAP LS308)
- BOUNDARY LINE
- LOT LINE
- EXIST. PROPERTY LINES
- EXIST. EASEMENTS

HATCH LEGEND

- STORM SEWER, SANITARY SEWER AND DRAINAGE EASEMENT (INST. No. 201708858)
- DEDICATED UTILITY EASEMENT (INSTRUMENT: 201708858)

STORM SEWER, SANITARY SEWER AND DRAINAGE EASEMENT (INST. No. 201708858)

DEDICATED UTILITY EASEMENT (INST. No. 201708858)

STORM SEWER, SANITARY SEWER AND DRAINAGE EASEMENT (INST. No. 201708858)

DEDICATED UTILITY EASEMENT (INST. No. 201708858)

NOTES:

- ALL ANGLES ARE 90° UNLESS OTHERWISE NOTED.
- ALL LOT LINES ARE RADIAL TO CURVED STREETS UNLESS SHOWN AS NONRADIAL (N.R.).
- ALL EASEMENTS THAT ARE NOT LABELED WITH ANY RECORDING INFORMATION WILL BE RECORDED BY A SEPARATE DOCUMENT.

APPROVAL OF OMAHA PLANNING DIRECTOR

APPROVED AS A SUBDIVISION OF NOT MORE THAN TWO (2) LOTS, PARCELS OR TRACTS, WITH PLAT REQUIREMENTS WAVED PER SECTION 7.08 HOME RULE CHARTER OF THE CITY OF OMAHA, 1968. THIS SUBDIVISION APPROVAL IS VOID UNLESS THIS PLAT IS FILED AND RECORDED WITH THE COUNTY REGISTER OF DEEDS WITHIN THIRTY (30) DAYS OF THIS DATE.

OMAHA PLANNING DIRECTOR _____ DATE _____

SURVEYORS CERTIFICATION

I HEREBY CERTIFY THAT I HAVE SURVEYED ALL OF LOTS 1, THRU 4, ANTLER VIEW REPLAT 2, A SUBDIVISION LOCATED IN THE NW1/4 OF NW1/4 OF SECTION 8, TOWNSHIP 15 NORTH, RANGE 11 EAST OF THE 6TH P.M., DOUGLAS COUNTY, NEBRASKA.

SAID TRACT OF LAND CONTAINS AN AREA OF 157,248 SQUARE FEET OR 3.599 ACRES MORE OR LESS.

JOHN W. VON GÖLLEN US 979 _____ DATE _____

COUNTY TREASURER'S CERTIFICATE

THIS IS TO CERTIFY THAT I FIND NO REGULAR OR SPECIAL TAXES DUE OR DELINQUENT AGAINST THE PROPERTY DESCRIBED IN THE SURVEYORS CERTIFICATE AND AS SHOWN BY THE RECORDS OF THIS OFFICE.

DOUGLAS COUNTY TREASURER _____ DATE _____

OWNER'S CERTIFICATION

KNOW ALL PERSONS BY THESE PRESENTS, THAT THE UNDERSIGNED ARE OWNERS OF THE PROPERTY CAUSED TO BE SUBDIVIDED INTO LOTS AS SHOWN ON THIS PLAT, AND HAVE CAUSED SAID LAND TO BE SUBDIVIDED INTO LOTS AS SHOWN ON THIS PLAT.

FF INVESTMENTS, LLC

CHRISTOPHER FALCONE, MANAGING MEMBER _____ DATE _____

ACKNOWLEDGEMENT OF NOTARY

STATE OF NEBRASKA)
 COUNTY OF DOUGLAS)

ON THIS _____ DAY OF _____ BEFORE ME, THE UNDERSIGNED, A NOTARY PUBLIC IN AND FOR SAID COUNTY, PERSONALLY CAME CHRISTOPHER FALCONE, MANAGING MEMBER OF FF INVESTMENTS, LLC, WHO IS PERSONALLY KNOWN TO BE THE IDENTICAL PERSON WHOSE NAME IS AFFIXED TO THE DEDICATION ON THIS PLAT AND ACKNOWLEDGED THE SAME TO BE HIS VOLUNTARY ACT AND DEED.

WITNESS MY HAND AND NOTARIAL SEAL, THE DAY AND YEAR LAST ABOVE WRITTEN.

NOTARY PUBLIC _____

<p>E & A CONSULTING GROUP, INC. Engineering • Planning • Environmental & Field Services</p> <p>11093 Mill Valley Road, Suite 100 • Omaha, NE 68154 Phone: 402.852.7700 • Fax: 402.852.3598 www.eaog.com</p>					
<p>ANTLER VIEW REPLAT 2 LOTS 1 THRU 4 INCLUSIVE OMAHA, NEBRASKA</p>					
<p>ADMINISTRATIVE SUBDIVISION</p>					
<p>Proj. No.: P2018.255.001</p> <p>Date: 09/27/2019</p> <p>Drawn By: JBS</p> <p>Scale: 1" = 60'</p> <p>Sheet: 1 of 1</p>	<p>Revisions</p> <table border="1"> <thead> <tr> <th>Date</th> <th>Description</th> </tr> </thead> <tbody> <tr> <td></td> <td></td> </tr> </tbody> </table>	Date	Description		
Date	Description				

EXHIBIT "C"

UNIT OWNERSHIP AND PERCENTAGE INTERESTS TABLE

<u>Unit No.</u>	<u>Square Footage</u>	<u>Allocated Interest of Common Elements</u>	<u>Allocated Interest of Common Expenses</u>	<u>Number of Votes in Association Matters</u>
1A	1,664	14.73%	14.73%	1
1B	2,320	20.54%	20.54%	1
1C	1,664	14.73%	14.73%	1
1D	1,664	14.73%	14.73%	1
1E	2,320	20.54%	20.54%	1
1F	1,664	14.73%	14.73%	1
Totals	11,296	100%	100%	6