

**DECLARATION OF COVENANTS, CONDITIONS AND RESTRICTIONS
FOR HEARTWOOD PRESERVE
OMAHA, DOUGLAS COUNTY, NEBRASKA**

Return: Noddle Development Co.
2285 S 67th St., Suite 250
Omaha, NE 68106

**DECLARATION OF COVENANTS, CONDITIONS AND RESTRICTIONS
FOR HEARTWOOD PRESERVE
OMAHA, DOUGLAS COUNTY, NEBRASKA**

NEW WEST FARM HOLDINGS, LLC, a Nebraska limited liability company and **SOUTH FARM, LLC**, a Nebraska limited liability company (collectively “Declarant”) hereby execute this **DECLARATION OF COVENANTS, CONDITIONS AND RESTRICTIONS** (this “Declaration”) as of the date set forth below.

RECITALS

A. Declarant has made that certain plat of West Farm, which plat was recorded as instrument #2017027700 of the Deed Records of Douglas County, Nebraska (the “West Farm Plat”) and that certain plat of South Farm, which plat was recorded as instrument #2018043962 of the Deed Records of Douglas County, Nebraska (the “South Farm Plat”).

B. Declarant intends that the property within the West Farm Plat and the South Farm Plat (collectively the “Heartwood Property”) will become subject to the covenants, conditions and restrictions set forth in this Declaration. The Heartwood Property is legally described on Exhibit A, attached hereto and incorporated by this reference.

C. The Heartwood Property will be developed in accordance with the West Farm Mixed-Use District Plan or the South Farm Mixed-Use District Plan (as relevant), the West Farm/South Farm Master Plan, and the West Farm/South Farm Design Guidelines (collectively the “Development Plans”), attached hereto as Exhibit C and incorporated by this reference as if fully set forth herein. The Heartwood Property is divided into nineteen (19) separate development zones (collectively, “Development Zones”, or singularly, a “Zone”), as set forth and numbered in the Heartwood Development Program (the “Development Program”), attached hereto as Exhibit B and incorporated by this reference as if fully set forth herein, The description for the lots included in each Zone are set forth on Exhibit B.

E. The Heartwood Property shall be developed in harmony with the Development Plans so as to provide a unified project which is consistent with the design principles employed in the development of the Heartwood Property as provided for in Section 3(b).

F. Each and every one of these covenants, conditions, reservations and restrictions is for the benefit of each owner of any land within the Heartwood Property and shall inure to and pass with each and every tract, or any parcel, lot or site thereof and shall bind the respective assigns and successors in interest of the present owners (whether such successor owners acquire such property by grant, gift, foreclosure, deed in lieu of foreclosure or otherwise). These covenants, conditions, reservations and restrictions are each imposed upon the tracts, and are all to be construed as restrictive covenants running with the property and with each and every part thereof:

Section 1. Permitted Uses. Subject to the remaining provisions of this Declaration, each Zone or Lot may be used only for the designated uses described in the Development Agreement dated March 28, 2017 between the City of Omaha and New West Farm Holding, LLC and Development Agreement dated March 10, 2017 between the City of Omaha and South Farm, LLC (collectively the “Development Agreement”)

and further described herein (the “Permitted Uses”) and may be used for no other purpose. The Permitted Uses set forth herein are intended to be additional restrictions upon the use of the property within the Heartwood Property and are not intended to amend or modify in any manner the uses permitted under the mixed use zoning district applicable to the Heartwood Property, as such mixed use district may be modified from time to time. Any use proposed for the Heartwood Property must be an allowed use under the mixed use zoning district as well as a Permitted Use hereunder for such use to be implemented. Any amendment to the Permitted Uses hereunder shall not be deemed to change or modify in any manner the allowed uses under the Development Agreement applicable to the Heartwood Property.

Section 2. Prohibited Uses and Improvements.

(a) ***First Class Environment.*** No use of any property in any portion of the Heartwood Property shall be inconsistent with a first-class environment, as determined in the reasonable discretion of the Architectural Control Committee.

(b) ***Industrial; Manufacturing; Excavation.*** No property in the Heartwood Property may be used for industrial or manufacturing uses, refuse collection (other than refuse collection facilities for buildings within the Heartwood Property which comply with the terms of this Declaration) or related uses. No rock, gravel, clay or other material shall be excavated or removed from any property in any Area for commercial purposes except strictly as necessary to prepare the site for permitted buildings and improvements.

(c) ***Nuisances; Hazardous Waste; Environmental Hazards.*** No noxious weeds or underbrush shall be permitted to grow or remain upon any property in any Area, and no refuse pile, construction debris, unused motor vehicle, or other private nuisance of any kind shall be allowed to be placed or to remain anywhere on any Lot. No uses producing hazardous or toxic waste or other environmental hazards shall be permitted upon any property on any Lot. In the event that an owner of any Lot shall fail or refuse to keep such property free from any such private nuisance, waste or environmental hazard, the Association (as defined in Section 4 of this Declaration) or its designated representative (the “Designated Representative”) may enter upon such property and remove such nuisance, waste or hazard at the expense of the owner of such property, and such entry shall not be deemed a trespass.

(d) ***Gambling.*** No gambling or wagering of any kind shall be permitted within the Heartwood Property, except that (i) Nebraska State Lottery tickets may be sold at retail establishments in accordance with applicable laws and regulations and (ii) with the prior approval of the Architectural Control Committee, an establishment serving food and beverages, located within a platted lot within the Heartwood Property, may conduct keno games and sell “pickle cards” in accordance with City of Omaha and State of Nebraska laws and regulations.

(e) ***Sexually Oriented Commercial Activities.*** No portion of the Heartwood Property shall be used, whether by the owner or any lessee thereof, to engage in any commercial endeavor which primarily conducts, markets, promotes or sells items or activities of a sexually oriented nature.

(f) ***Temporary Buildings.*** No temporary buildings, trailers, manufactured homes or other structures, mobile homes or structures, modular facilities or other similar structures shall be allowed upon any property within the Heartwood Property, except that, with the prior approval of the Architectural

Control Committee in connection with an approved construction plan, retail and restaurant container structures may be permitted and container or shelter structures for seasonal activities (i.e. ice skating). Construction trailers and related temporary facilities may be permitted as reasonably required by construction contractors then engaged in constructing improvements within the Heartwood Property.

(g) **Signage.** No stand-alone outdoor advertising signs or billboards shall be permitted upon any lot within the Heartwood Property.

(h) **Temporary Landscaping.** No undeveloped land shall remain in any Zone without a temporary landscaping plan installed and maintained by the owner of such property which presents an attractive appearance.

(i) **Automotive:** No automotive sales or service shall be permitted within the Heartwood Property except for Zone 2. Except as otherwise approved by the Architectural Control Committee, the automotive brands permitted on Zone 2 are limited to Jaguar, Land Rover, BMW, and Mini Cooper. Any carwash shall be contained within a parking structure or similar structure except for Zone 2 which may be within a separate carwash structure. All carwashes will be an amenity to serve the employees and invitees of that Lot and will not be open or sell services to the general public.

(j) **Miscellaneous.** No fireworks display shall be allowed within the Heartwood Property, except within Heartwood Park. No activity which is reasonably anticipated to over-burden available parking facilities shall be permitted within the Heartwood Property. No portion of the Heartwood Property shall be used, whether by the owner or any lessee thereof, to engage in any commercial endeavor which markets, promotes or sells items associated with:

- (i) shops with the principal purpose of which is the sale of cigarettes and other tobacco products;
- (ii) tattoo parlors or shops providing tattoos;
- (iii) pawn shops and other businesses offering payday advances, cash advances or payday loans;
- (iv) gun shops or other businesses providing for the sale or discharge of firearms; or
- (v) fireworks.

(k) **Temporary Construction Facilities.** Notwithstanding the foregoing, the temporary concrete batch plant contemplated on Zone 19 shall be a permitted use.

Section 3. Site Development Regulations.

(a) **Development Plans.** All new building and improvements, or material modifications to existing buildings or improvements, located in any area shall comply with the Development Plans.

(b) **Urban Design Principles.** All development within the Heartwood Property shall be consistent with basic urban design principles as set forth in the Development Plans, including, but not limited to:

- (i) wide, pedestrian-friendly sidewalks with extensive landscaping and specialty lighting;
- (ii) plazas and other small gathering spaces incorporated into pedestrian system;
- (iii) buildings that front on the sidewalks with little or no setbacks; except where building are deliberately pulled away from the street to create public plazas, pedestrian areas, and other special areas;
- (iv) localized streets with on-street parking;
- (v) off-street parking facilities, either structures or surface lots, located behind and screened by buildings; and
- (vi) building architecture and design which presents a consistent theme, rhythm and use of materials.

(c) **Densities.** Minimum development densities for each Zone within the Heartwood Property must meet or exceed those shown on the Development Program.

(d) **Exterior Appearance.** All structures within the Heartwood Property must present a credible appearance on all sides consistent with a first-class development, and be subject to approval of the Architectural Control Committee as set forth in Section 5(b) of this Declaration.

(e) **Maximum Height.** The maximum height of any structure within the Heartwood Property shall not exceed the heights set forth in Exhibit D attached hereto and incorporated by this reference.

(f) **Parking.** Each owner shall make provisions for adequate off-street parking in accordance with the standards established by the Architectural Control Committee and the Design Guidelines; provided, however, that at no time may standards established by the Architectural Control Committee and/or Design Guidelines for the Heartwood Property be adopted or amended without the consent of Declarant or its designee such that less than: (i) 4.01 stalls must be provided for each 1,000 square feet of usable retail space; (ii) 4.01 stalls must be provided per 1,000 usable square feet of office space; provided, however, that in no event shall the usable square feet of any office space be less than 90% of the rentable square feet in said space; (iii) 1.25 stalls must be provided per residential unit; and/or (iv) 1.0 stalls must be provided for each hotel room (collectively, the "Parking Ratios"). Under no Circumstance shall parking stalls on city streets be included in determining compliance with the foregoing parking requirements.

All parking areas shall be either properly landscaped hard surface lots or parking structures. Furthermore except as approved by the Architectural Control Committee, until December 31, 2030 a minimum of 80% of each Zone's non-residential parking areas (excluding Zones 2, 15, and 18) in the Heartwood Property shall be available and open to the public for all hours of the day except between 7:00 a.m. and 6:00 p.m. and non-holiday weekdays, which exclusionary period shall hereinafter be referred to as "Business Hours."

(g) **Cross Parking Easements.** Each owner of any land within Zones 1, 4, and 5 of the Heartwood Property (collectively, the "Cooperating Owners") hereby grants and conveys to every other Cooperating Owner and such Cooperating Owner's lessees, customers and invitees conducting business

within the Heartwood Property a non-exclusive easement to park passenger vehicles on any portions of such Cooperating Owner's land which are paved and striped for parking from time to time (collectively, the "Parking Areas") located on such Cooperating Owner's property, so as to keep them at all times in a safe, functional and first class manner, clean and free from snow, ice, refuse and rubbish; (ii) repave, restripe and replace markings on the surface of the Parking Areas and driveways in the Parking Areas from time to time as and when necessary so as to provide for the orderly parking of automobiles and shall place and maintain adequate exit and entrance and other traffic control signs to direct traffic in and out of the Parking Areas and (iii) maintain all landscaping in the Parking Areas. The configuration of the driveways, curb cuts, landscaping and parking areas within the Parking Areas may be reconfigured, moved or otherwise modified in any manner so long as each Cooperating Owner provides the minimum parking required by this Declaration.

(h) **Loading Areas; Trash Receptacles; Mechanical Equipment.** All loading areas and loading docks, trash receptacles, antennae, satellite dishes and mechanical equipment shall be off-street and screened from adjacent streets and sidewalks.

(i) **Exterior Lighting.** Owners shall install or cause to be installed sufficient exterior lighting so as to properly illuminate drives, parking facilities, streets and sidewalks. Where appropriate, decorative lighting will be employed in accordance with the requirements of the Design Guidelines.

(j) **Landscaping.** Upon completion of any building or parking facility (or the next available planting season), the owner shall install landscaping in accordance with the requirements of the Design Guidelines.

(k) **Signage.** No exterior signs incorporating flashing, pulsating or rotating lights shall be permitted, and no exterior walking or message signs (except time and temperature) shall be permitted, except for those the Architectural Control Committee may approve in portions of the Heartwood Property. No pole signs or roof signs shall be permitted.

(l) **Utilities.** All permanent utilities providing local service to the Heartwood Property shall be underground.

Section 4. Master Property Owners Association.

(a) **Formation.** A Master Property Owners Association (the "Association") shall be formed for purposes of (i) accepting the dedication of use easements for certain common areas; (ii) owning certain common areas; and (iii) improving and maintaining such common areas within the Heartwood Property.

(b) **Organization.** Except for owners of condominium interests or owners in fee simple of residential property comprising less than one acre in size (which the declarants have intentionally chosen to exclude from voting), each owner of land within the Heartwood Property shall be a member of the Association (collectively, "Voting Owners"). Except as otherwise set forth in this Declaration, decisions of the Association shall be determined by a majority of the total number of authorized votes ("Authorized Votes") at the time such decision is made.

Initially, Authorized Votes shall be allocated to each zone within the Heartwood Property based on the approximate projected full buildout assessed value of each such Zone. The initial Authorized Votes for each such Zone shall be as follows:

<u>ZONE</u>	<u>VOTES</u>
1	3
2	1
3	13
4	1
5	2
6	6
7	9
8	1
9	11
10	8
11	1
12	5
13	1
14	6
15	3
16	3
17	5
18	10
19	<u>11</u>
Total	100

As a Zone is fully developed, in the event that there is a substantial difference between (i) the actual assessed value of the Zone and (ii) the initial projected assessed value, then the Association may make appropriate pro rata adjustments to the number of Authorized Votes assigned to that Zone and the total number of Authorized Votes.

In the event that a Zone is subdivided and/or title to a portion of a Zone is transferred to another party, then the owner subdividing or transferring title may allocate a portion of the Authorized Votes for that Zone to the subdivided and/or transferred parcel, such transfer to be totally at the option of the transferring owner and to become effective upon notice to the Association from the transferring owner of the member of Authorized Votes transferred and the name of the receiving party.

(c) **General Assessments.** The Association shall assess its members for the costs of (1) establishing and operating the Association, the Architectural Control Committee and any other committees or subcommittees; (2) enforcing the terms of this Declaration, (3) owning, maintaining and improving those common areas which provide general benefit for the entire Heartwood Property; (4) owning, maintaining and improving Heartwood Park (Lot 20 West Farm Replat 4); and (5) such reasonable operating reserves as the Association deems appropriate (collectively, the "Operating Expenses"). Such common areas will include, but are not limited to, parks and public open space (consisting of Lot 23 West Farm Replat 4, Lot 24 West Farm Replat 4, Lot 30 West Farm Replat 4, Lot 5 South Farm, Lot 10 South Farm, and Lot 11

South Farm), landscaping and street scape features within and immediately adjacent to public street rights-of-way, and other areas or features accepted by the Association as the common areas, which areas shall include any public restrooms or facilities made available to the general public on a permanent basis that are accessible without entering an office building or retail establishment.

Assessments for Operating Expenses shall be apportioned to each member pro rata based on the number of each member's Authorized Votes.

(d) ***Duties; Authority.*** The Association shall have authority to enforce the covenants, conditions and restriction set forth in this Declaration, assess owners for costs, and place and foreclose liens on property for unpaid assessments in accordance with Section 6 of this Declaration. Owners with unpaid assessments shall have their voting rights in the Association suspended until such time as such assessments are paid in full. The Association shall carry appropriate forms and amounts of insurance.

(e) ***Sub-Associations.*** Owners of certain parcels within the Heartwood Property, including owners of condominium interests and/or owners in fee simple of residential property consisting of less than one acre in size, may form sub-associations ("Sub-Associations") for the purpose of owning, improving, maintaining and operating certain common areas and facilities which provide specific benefits for the particular parcels, including, but not limited to, parking facilities. Each Sub-Association shall have the same authority and obligations as the Association with respect to the parcels included within the Sub-Association. Each Sub-Association shall establish its own boundaries, membership and voting procedures, which membership and voting procedures may be different from that of the Association. Each Sub-Association may establish additional use restrictions, design standards to those set forth in this Declaration or in the Development Plans, Development Program or Design Guidelines.

Section 5. Architectural Control Committee.

(a) There is hereby established the Architectural Control Committee, which shall initially consist of three members, one member of which shall be Steve Menzies, or such other person as may be appointed by the Declarant (the "Declarant Seat"), one member of which shall be Jay Noddle, or such other person as may be appointed by Noddle Development Company (the "Developer Seat"), and one member of which shall be collectively appointed by the owner or owners of property within Zones 1-19 as shown on the Development Program in Exhibit B (the "At-Large Seat").

(i) Upon the death, Disability, resignation or removal of the person holding the Declarant Seat, a new member of the Architectural Control Committee to fill the seat occupied by such person shall be appointed by Declarant.

(ii) Upon the death, Disability, resignation or removal of the person holding the Developer Seat, a new member of the Architectural Control Committee to fill the seat occupied by such person shall be appointed by Noddle Development Company.

(iii) "Disability" means (i) the inability of an individual to physically perform his/her job responsibilities for at least six (6) consecutive months, or (ii) an adjudication by a court of competent jurisdiction that an individual is incapable of managing his/her own financial affairs.

(b) At such time as none of Declarant or any of Declarant's affiliates owns any property within the Heartwood Property, then nominations to fill the Declarant Seat shall be made by the owners of Zones 1-19. At such time as none of Noddle Development Company or any of Noddle Development Company's affiliates owns any property within the Heartwood Property, then nominations to fill the Developer Seat shall be made by the owners of Zones 1-19. Once nominations have been received, the owners entitled to submit nominations shall then elect such member of the Architectural Control Committee utilizing the same number of votes allocated to said owners pursuant to Section 4(b). Each member of the Architectural Control Committee shall serve at the pleasure of their appointing entity, if any, and may be replaced by such appointing entity at any time upon notice to the remaining members. The Architectural Control Committee shall meet as required at such place and at such time as in mutually agreeable to the members thereof.

(c) Before commencing the construction, addition, installation, modification, demolition or alteration of any building, enclosure, landscaping, fence, parking facility, sign, light pole, fence or fixture, or any other structure or temporary or permanent improvements within the Heartwood Property (except for interior construction or remodeling), and except as expressly provided in this Declaration, the owner of the property upon which such development is located shall provide to the Architectural Control Committee for its approval the site plans, grading and utility plans, landscaping plans, sign and sign allocation plans, floor plans and building elevations, and materials plans, demolition plans and such other plans and specifications as may be appropriate (collectively, "Proposed Plans"). The Architectural Control Committee shall adopt by majority vote, appropriate procedures for plan submission, review and approval. Approval of plans shall require the affirmative vote of two members of the Architectural Control Committee; provided, however, that so long as a representative of Declarant is a member of the Architectural Control Committee, then one of the affirmative votes must be from the representative of Declarant.

(d) The Design Guidelines are attached hereto as part of the Development Plans. The Architectural Control Committee may amend, by majority vote, the Design Guidelines with respect to each type of improvement within the Heartwood Property; provided, however, that so long as a representative of Declarant is a member of the Architectural Control Commission, then one of the affirmative votes must be from the representative of Declarant.

(e) The Architectural Control Committee may retain outside consultants to assist in its activities, and may charge reasonable fees for plan review. The Architectural Control Committee may consult with other property owners as part of its review process.

Section 6. Remedies For Violations; Liens. Upon a violation or breach of any of the covenants, conditions, reservation and restrictions set forth in this Declaration with respect to any property, subject to this Declaration, the Association or its Designated Representative shall have the right to proceed at law or in equity to compel compliance with the terms hereof or to prevent the violation or breach of any of the them. The failure promptly to enforce any of the covenants, conditions, reservations and restrictions contained here in shall not bar their enforcement or be deemed a waiver of any future violations. Upon the failure or refusal of the Association or its Designated Representative to enforce any of the covenant, conditions, reservations and restriction set forth herein, any individual member of the Association shall

have the right, but not the obligation, to proceed at law or equity to compel compliance therewith or to prevent or enjoin any actual or threatened violation or breach of the same.

In addition to the foregoing rights, the Association or its Designated Representative shall have the right, whenever there exists any condition on the Heartwood Property which is in violation of this Declaration and such violation has not been cured within 30 days after written notice to the breaching party, to enter upon the property where such violation exists and summarily abate or remove the same at the expense of the owner, payable within 30 days after such breaching party is billed. Any such entry and abatement or removal shall not be deemed a trespass. The cost of such abatement or removal, if not paid within such 30-day period, shall be a lien in favor of the Association against the breaching owner's property and, subject to the provision of Section 14 below, may be foreclosed by the curing party in like manner as any other lien against real estate.

Section 7. Waiver and Variance By Architectural Control Committee. The owner of any property within the Heartwood Property may petition the Architectural Control Committee to waive compliance with or grant a variance to any of the covenants, conditions, reservations or restriction set forth in Sections 1, 2 and 3 of this Declaration. Subject to the limitation set forth below, and based on its reasonable discretion, the Architectural Control Committee is hereby given the power to waive or grant a variance to any such covenants, conditions, reservations or restrictions upon such request and upon a finding by the Architectural Control Committee that such request is in conformity with the general scheme for the development of the Heartwood Property as set forth in this Declaration. Such waiver or variance may be conditioned by the Architectural Control Committee. Such waiver or variance shall be effective only upon the unanimous consent of the Architectural Control Committee. Notwithstanding any other provision contained herein, if the Architectural Control Committee shall fail to approve or disapprove any such requests for waiver or variance within 30 days after such request has been submitted to the Architectural Control Committee, such request shall be deemed conclusively to have been disapproved unless or until the Architectural Control Committee takes further action on the same, if ever.

Section 8. Term and Extensions. Each covenant, condition, reservation and restriction contained in this Declaration shall continue in effect indefinitely until terminated as provided below as of a Termination Date, the first of which shall be on July 1, 2048. At any time within one year prior to July 1, 2048, and each 30-year anniversary thereafter (each such date being referred to herein as a "Termination Date"), by majority vote of the Voting Owners, the Association may, by written declaration signed and acknowledged by a majority of the approving Voting Owners and duly recorded with the Register of Deeds for Douglas County, Nebraska, terminate the covenants, conditions, reservations and restrictions herein, effective as of the next Termination Date. Failing such termination, the covenants, conditions, reservations and restrictions contained in this Declaration shall automatically be renewed and extended for successive periods of 30 additional years, subject to the right of the Association by a vote of the majority of the Voting Owners to terminate this Declaration at the end of each such 30-year period as provided in this Section.

Section 9. Interest. Whenever and as often as one party shall not have paid any sum payable hereunder to another party, or to the Association, any Sub-Association or the Architectural Control Committee, within 30 days of the due date, such delinquent party shall pay interest on such amount from the due date to the date such payment is received by the party entitled thereto, at an interest annual rate equal to the prime rate plus five percentage points.

Section 10. Estoppel Certificate. Each owner of any property within the Heartwood Property agrees that upon written request of any other party (which shall not be more frequent than three times during any calendar year by a single requester), it will issue to a prospective mortgagee or successor of such other owner or to such other party, an estoppel certificate stating to the best of the issuer's knowledge that as of such date:

- (a) whether the owner to whom the request has been directed knows of any default by the requesting party under this Declaration, and if there are known defaults, specifying the nature thereof;
- (b) whether this Declaration has been modified or amended in any way by the requested owner (and if it has, then stating the nature thereof); and
- (c) whether this Declaration is in full force and effect.

Such Statement Shall act as a waiver of any claim by the owner furnishing it to the extent such claim is based upon facts contrary to those asserted in the statement and to the extent the claim is asserted against a bona fide encumbrancer or purchaser for value without knowledge of facts to the contrary of those contained in the statement, and who has acted in reasonable reliance upon the statement; however, such statement shall in no event subject the owner furnishing it to any liability whatsoever, notwithstanding the negligent or otherwise inadvertent failure of such owner to disclose correct and/or relevant information.

Section 11. Notices. All notices, demands, statements and requests (collectively "Notices") required or permitted to be given under this Declaration must be in writing and shall be deemed to have been properly given or served as of the date hereinafter specified (a) on the date of personal service upon the person to whom the Notice is addressed or if such person is not available the date such Notice is left at the address of the person to whom it is directed, (b) on the date the Notice is postmarked by the United States Post Office, provided it is sent prepaid, registered or certified mail, return receipt requested and (c) on the date the Notice is delivered by a nationally recognized overnight courier service, postage prepaid and addressed to the person to whom it is directed. The addresses of certain of the signatories to, or the anticipated ultimate owners of the property subject to, this Declaration to which Notices shall be sent are set forth below.

if to Declarant:

Applied Underwriters
10805 Old Mill Road
Omaha, Nebraska 68154
Attn: Jeffrey A. Silver

with copies to:

Noddle Companies
2285 S. 67th Street, Suite 250
Omaha, Nebraska 68106
Attn: Jay Noddle

The place for delivery of any Notice hereunder may be changed by any party or its successor in interest) by written notice to the other parties delivered in the manner required by this paragraph. As to any successor owner, upon acquisition of ownership of a parcel within the Heartwood Property, such new owner may give notice of its address as provided in this Section. If the new owner gives such a notice, future Notices must be given to said owner at that address. If the new owner does not give such notice, future Notices shall be effective if sent to the address of the record owner of the property as shown on the real property tax records of Douglas County, Nebraska.

Section 12. Declaration Shall Continue Notwithstanding Breach. It is expressly agreed that no breach of this Declaration shall (a) entitle any party to cancel, rescind or otherwise terminate this Declaration or (b) defeat or render invalid the lien of any mortgage or deed of trust made in good faith and for value as to any part of the Heartwood Property. However, such limitation shall not affect in any manner any other rights or remedies which a party may have hereunder by reason of any such breach.

Section 13. Approval Rights. Unless provisions is made for a specific time period (such as the time for approval as set forth in Section 5), approval or consent requested pursuant to this Declaration shall be given or withheld within 60 business days of the receipt of the request for approval. Except as otherwise provided in this Declaration, if a disapproval is not given within the required time period, the requested party shall be deemed to have given its approval. Except with respect to any approval or disapproval given by lapse of time under the terms of this Declaration, all approvals and disapprovals shall be in writing, but the failure to furnish such a writing shall not be deemed an approval.

Section 14. Lien For Expenses.

(a) The liens provided for in Section 6 above shall be effective only when a signed and acknowledged document providing notice of such lien is filed by the Association or its Designated Representative in the Office of the Register of Deeds for Douglas County, Nebraska, which notice shall contain at least:

- (i) A statement of the unpaid amount of costs and expenses;
- (ii) a description sufficient for identification of that portion of the property of the defaulting owner which is the subject of the lien; and
- (iii) the name of the owner or reputed owner of the property which is the subject of the alleged lien.

(b) The lien, when so established against the real property described in the lien, shall be prior and superior to any right, title, interest, lien or claim which may be or has been acquired or attached to such real property after the time of filing the lien.

The lien shall be for the use and benefit of the Association and may be enforced and foreclosed in a suite or action brought in any court of competent jurisdiction.

Section 15. Dispute Resolution. Expressly excluding matters to be determined by the Architectural Control Committee hereunder, all other disputes and controversies of every kind and nature between or among the parties hereto arising out of or in connection with this Declaration as to the existence, construction, validity, interpretation or meaning, performance, nonperformance, enforcement, operation,

breach, continuance, or termination hereof shall be submitted to arbitration pursuant to the procedure hereafter set forth:

(a) Any party may demand such arbitration by written notice to the remaining owners of all property within the Heartwood Property within 30 days after the controversy arises, which notice shall include the name of the arbitrator appointed by the party demanding arbitration, together with a statement of the matter in controversy.

(b) Within 15 days after such notice, the remaining parties shall name their respective arbitrator, or in default of such naming, such arbitrator or arbitrators shall be named forthwith by the Arbitration Committee of the American Arbitration Association.

(c) The arbitration costs and expenses of each party shall be borne by that party.

(d) The arbitration hearing shall be held on 15 days' notice to the parties at a neutral site in Omaha, Nebraska, to be selected by a majority of the arbitrators.

(e) The arbitration rules and procedures of the American Arbitration Association shall be utilized in the arbitration hearing, and the law of evidence of the State of Nebraska shall govern the presentation of evidence at such hearing.

(f) The arbitration hearing shall be concluded within three days unless otherwise ordered by a majority of the arbitrators, and the award or determination on the hearing shall be made within 10 days after the close of the submission of evidence.

(g) An award or determination rendered by a majority of the arbitrators appointed under and pursuant to this Section 15 shall be final and binding on all parties to the proceeding, and judgment on such award or determination may be entered by any party in the highest court, state or federal, having jurisdiction over the matter.

(h) The parties stipulate that a decision rendered pursuant to the provisions of this Section 15 shall be a complete defense to any suit, action or proceeding instituted in any federal, state or local court or before any administrative tribunal with respect to any controversy or dispute arising hereunder and which is arbitrable as set forth in this Section 15. The arbitration provisions of this Section 15 shall, with respect to such controversy or dispute, survive the termination of any party's ownership of any one of the Tracts. Nothing contained in this Section 15 shall be deemed to give the arbitrators any authority, power or right to alter, change, amend, modify, add to or subtract from any of the provisions of the Amended Declaration.

Section 16. Effect of Sale By Owner. If any owner of any property in the Heartwood Property sells its property, then after the date of sale such owner shall have no further obligation under this Declaration with respect to such property sold; provided, however, the selling owner shall remain liable for obligations incurred prior to said sale.

Section 17. Default in Payment of Expenses. Notwithstanding any of the provisions of this Declaration, a breach of any of the conditions and covenants contained herein shall not defeat, affect or render invalid the lien of any mortgage or deed of trust made in good faith and for value, but such conditions

and covenants shall be binding and effective against any owner of any property or any portion thereof whose title thereto is acquired by foreclosure, trustee's sale or otherwise.

Section 18. Rule Against Perpetuities. In the event the provision hereunder are declared void by a court of competent jurisdiction by reason of the period of time herein stated for which the same shall be effective being contrary to applicable law or prohibited by the "rule against perpetuities" or any similar law, then in that event only the term hereof shall be reduced to the maximum period of time which does not violate such law or the rule against perpetuities as set forth in the laws of the State of Nebraska.

Section 19. Waiver. No delay or omission on the part of the Architectural Control Committee, the Association, any Sub-Association, or the owners of any property in the Heartwood Property in exercising any rights, power or remedy herein provided, in the event of any breach of the covenant, conditions, reservation or restriction herein contained, shall accrue nor shall any action be brought or maintained by anyone whatsoever against the Architectural Control Committee, the Association or any Sub-Association for on account of its failure to bring any action on account of any breach of these covenant, conditions reservations or restrictions.

Section 20. Severability. In the event any one or more of the foregoing covenants, conditions, reservations or restriction is declared for any reason by a court of competent jurisdiction to be null and void, the judgement or decree shall not in any manner whatsoever affect, modify, change, abrogate or nullify any of the other covenants, conditions, reservations and restrictions not specifically declared to be void or unenforceable, but all of the remaining covenants, conditions, reservations and restrictions not expressly held to be void or unenforceable shall continue unimpaired and in full force and effect.

Section 21. Beneficiaries. These covenants, conditions, reservations and restrictions are made for the benefit of any and all persons who may now own, or who may in the future own, property in the Heartwood Property, Such persons are specifically given the right to enforce these restrictions and covenants by injunction or other legal or equitable procedure as provided herein, and to recover damages resulting from any violation thereof, including the cost of enforcing the same, which costs shall include court costs and reasonable attorneys' fees as permitted by law.

Section 22. Amendment. This Declaration may be amended at any time by the written agreement of Declarant and two-thirds (2/3rds) of all Voting Owner, effective upon the recording of such amendment in the official real estate records of Douglas County, Nebraska; provided, however, that once Declarant relinquishes in writing its right to approve any amendment to this Declaration pursuant to this Section 22, thereafter this Declaration may be amended at any time by the written agreement of two-thirds (2/3rds) of all Voting Owners, effective upon the recording of such amendment in the official real estate records of Douglas County, Nebraska.

Section 23. Subsequent Amendments/Eminent Domain. In the event any improvement constructed in accordance with Proposed Plans approved by the Architectural Control Committee shall later be in violation of nay provision of this Declaration solely by reason of (a) a subsequent amendment to this declaration or (b) any eminent domain proceeding which may affect the location of public rights of way, then such improvement shall thereafter be deemed to comply with such provisions of this Declaration so long as the improvement is not materially modified or altered thereafter.

Section 24. Subsequently Acquired Property. In order to ensure the continued vitality and quality of the Heartwood Property, in the event any party hereto should acquire ownership of any piece of property located within the boundaries of the Heartwood Property or adjacent thereto, said party shall be obligated to record this Declaration and take any other action(s) necessary to ensure that said acquired property is used in conformity herewith and becomes subject hereto, which obligation may be specifically enforced by the Architectural Control Commission.

(REMAINDER OF PAGE INTENTIONALLY BLANK; SIGNATURE PAGES FOLLOW)

IN WITNESS WHEREOF, the undersigned party has hereto executed this Declaration of Covenants, Conditions and Restriction on the date set forth beneath its respective signature.

NEW WEST FARM HOLDINGS, LLC,
a Nebraska limited liability company

By: North American Casualty, Co., manager

By: _____

Name: Jeffrey Silver

Title: Vice President

Date: August 14, 2018

SOUTH FARM, LLC,
a Nebraska limited liability company

By: North American Casualty, Co., manager

By: _____

Name: Jeffrey Silver

Title: Vice President

Date: August 14, 2018

STATE OF NEBRASKA

COUNTY OF DOUGLAS

The foregoing instrument was acknowledged before me on August 14, 2018, by JEFFREY A. SILVER the VICE PRESIDENT of NEW WEST FARM HOLDINGS, LLC, a Nebraska limited liability company, known to me to be the identical person who signed the foregoing instrument and acknowledged the execution thereof to be his voluntary act and deed and the voluntary act and deed of said limited liability company.

SO OF NORTH AMERICAN CASUALTY Co.,
THE MANAGER OF

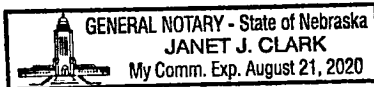

Janet J. Clark
Notary Public

My Commission expires: 8-21-2020

STATE OF NEBRASKA

COUNTY OF DOUGLAS

The foregoing instrument was acknowledged before me on August 14, 2018, by JEFFREY A. SILVER the VICE PRESIDENT of SOUTH FARM, LLC, a Nebraska limited liability company, known to me to be the identical person who signed the foregoing instrument and acknowledged the execution thereof to be his voluntary act and deed and the voluntary act and deed of said limited liability company.

↳ OF NORTH AMERICAN CASUALTY CO,
THE MANAGER

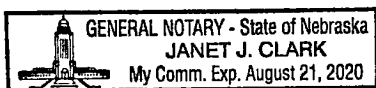

Janet J. Clark
Notary Public

My Commission expires: 8-21-2020

EXHIBIT A

HEARTWOOD PROPERTY LEGAL DESCRIPTION

Lots 3 and 9, West Farm, a subdivision, as surveyed, platted and recorded in Douglas County, Nebraska

Lots 2 through 9, inclusive, South Farm, a subdivision, as surveyed, platted and recorded in Douglas County, Nebraska

EXHIBIT B

HEARTWOOD PROPERTY DEVELOPMENT PROGRAM AND ZONES

“Zone 1”	West Farm Replat 2 Lot 1
“Zone 2”	West Farm Replat 2 Lot 2
“Zone 3”	West Farm Replat 3 Lot 1 and Replat 4 Lots 1, 2, 3
“Zone 4”	West Farm Lot 3
“Zone 5”	West Farm Replat 4 Lot 5
“Zone 6”	West Farm Replat 4 Lots 6, 7, 8
“Zone 7”	West Farm Replat 4 Lots 9, 10, 11, 12
“Zone 8”	West Farm Replat 4 Lots 31-39
“Zone 9”	West Farm Replat 4 Lots 13, 14, 15
“Zone 10”	West Farm Replat 4 Lots 16, 17, 18
“Zone 11”	West Farm Replat 4 Lots 19, 21
“Zone 12”	West Farm Replat 4 Lot 22
“Zone 13”	West Farm Lot 9
“Zone 14”	West Farm Replat 4 Lot 25
“Zone 15”	West Farm Replat 1 Lot 2
“Zone 16”	West Farm Replat 4 Lots 26, 27, 28
“Zone 17”	South Farm Lot 2
“Zone 18”	South Farm Lots 4 and Lot 1 Replat 1
“Zone 19”	South Farm Lots 6, 7, 8, Lot 2 Replat 1

WEST FARM PLAT					
Zone	Description	Platted Lots	Density		Value
			Units	GSF	
1	Large Format Retail, Phase 1	West Farm Replat 2, Lot 1	-	133,020	\$ 29,422,410
2	Luxuary Auto Dealership	West Farm Replat 2, Lot 2	-	21,805	\$ 6,138,158
3	Office Block	West Farm Replat 3, Lot 1 / Lot 1-4	-	458,692	\$ 137,895,405
4	Large Format Retail, Later Phase	West Farm Lot 3	-	30,150	\$ 7,310,114
5	Large Format Retail, Later Phase	Lot 5	-	72,000	\$ 15,875,592
6	Mixed Use- Northwest	Lot 6-8	-	202,828	\$ 58,970,204
7	Mixed Use- Northeast	Lot 9-12	171	423,286	\$ 96,782,438
8	The Row	Lot 31-39	-	1,080	\$ 342,662
9	Mixed Use- Southwest	Lot 13-15	509	336,690	\$ 109,486,421
10	Mixed Use- Southeast	Lot 16-18	395	472,410	\$ 77,634,254
11	Food Hall	Lot 19, 21	-	63,630	\$ 13,739,024
12	MFR- South	Lot 22	352	689,580	\$ 53,824,535
13	Office- South	West Farm Lot 9	-	40,500	\$ 10,694,130
14	TND	Lot 25	-	1,080	\$ 57,081,992
15	Assisted Living	West Farm Replat 1, Lot 2	270	291,276	\$ 35,123,313
16	Office- West	Lot 26-28	-	121,590	\$ 30,098,680
		Sub-total	1,697	3,359,617	\$ 740,419,332
NA	Open Space	Lot 30,24,20,23	-	-	\$ -
		Sub-total (w/ Open Space)	1,697	3,359,617	\$ 740,419,332
SOUTH FARM PLAT					
Zone	Description	Platted Lots	Density		Value
			Units	GSF	
17	Estate Lots	Lot 2	-	230,400	\$ 55,908,199
18	Corporate Campus	Lot 4 & Replat 1 Lot 1	-	364,500	\$ 103,772,976
19	South Mixed Use	Lot 6,7,8, and Replat 1 Lot 2	289	751,393	\$ 117,707,935
		Sub-total	289	1,346,293	\$ 277,389,110
NA	Open Space	Lot 5,3,10	-	-	\$ -
		Sub-total (w/ Open Space)	289	1,346,293	\$ 277,389,110
Total Development			1,985	4,705,910	\$ 1,017,808,442

Note:

Density is expressed as "units" for assisted living, multi-family, and hotel rooms. All other building type densities are expressed in gross building square feet.

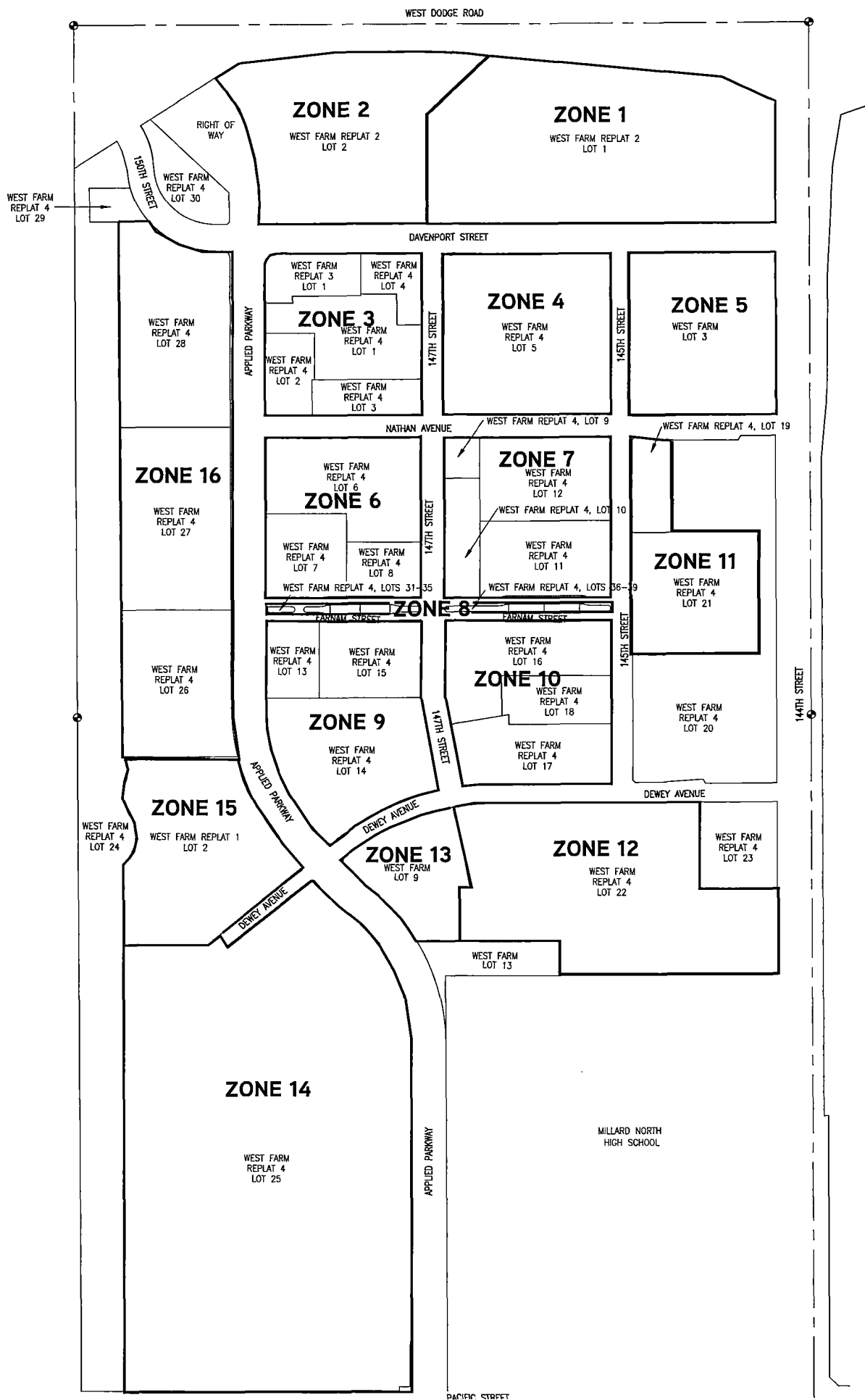

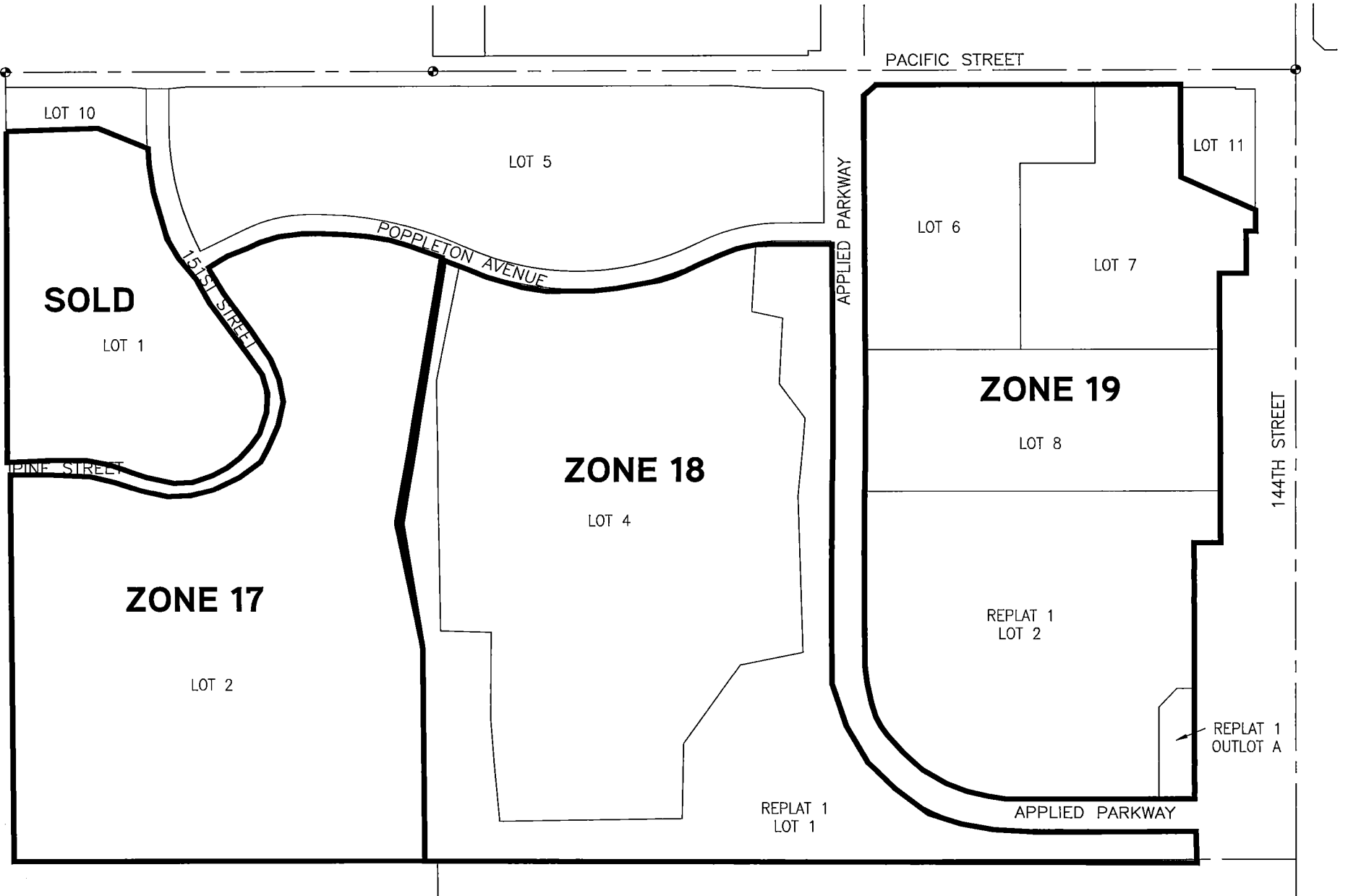

EXHIBIT C

MIXED-USE DISTRICT PLANS, MASTER PLAN, AND DESIGN GUIDELINES

(see attached)

01 MAR 2017

EXHIBIT B1



OMAHA, NEBRASKA | 01 MARCH 2017

West Farm/South Farm Master Plan

Prepared for **N NODDLE™**
COMPANIES

Prepared by URBAN DESIGN ASSOCIATES



OMAHA, NEBRASKA | 05 JANUARY 2017

South Farm Mixed-Use District Plan

Prepared for **N NODDLE™**
COMPANIES

Prepared by URBAN DESIGN ASSOCIATES

TABLE OF CONTENTS

PREPARED FOR
Noddle Development Company

CONSULTANT TEAM
Urban Design Associates
HDR, Inc.
HR&A Advisors
Lamp Rynearson & Associates, Inc.

WEST FARM/SOUTH FARM PLAN SUMMARY

WEST FARM/SOUTH FARM MASTER PLAN	2
DESIGN AND DEVELOPMENT PRINCIPLES	4

SOUTH FARM MASTER PLAN

SUMMARY OF SOUTH FARM MASTER PLAN	8
-----------------------------------	---

SOUTH FARM MIXED-USE DEVELOPMENT PLAN

LAND USE PLAN	14
MASSING DIAGRAMS	16
LANDMARKS, FOCAL POINTS, AND AXES	18
OPEN SPACE SYSTEM	20
OPEN SPACES IN SOUTH FARM	22
Pacific Recreation Area	22
Greenways	23
TRAIL SYSTEM	24
Parkway	28
Retail Street Parallel Parking	29
Multi-Family Street	30
Service Alleys	31
BUILDING SETBACKS	32
ACCESS AND SERVICE	34
PARKING	36
BUILDING TYPES	38
Retail, Mixed-Use, Office	38
Multi-Family Housing	40
Attached Housing	42

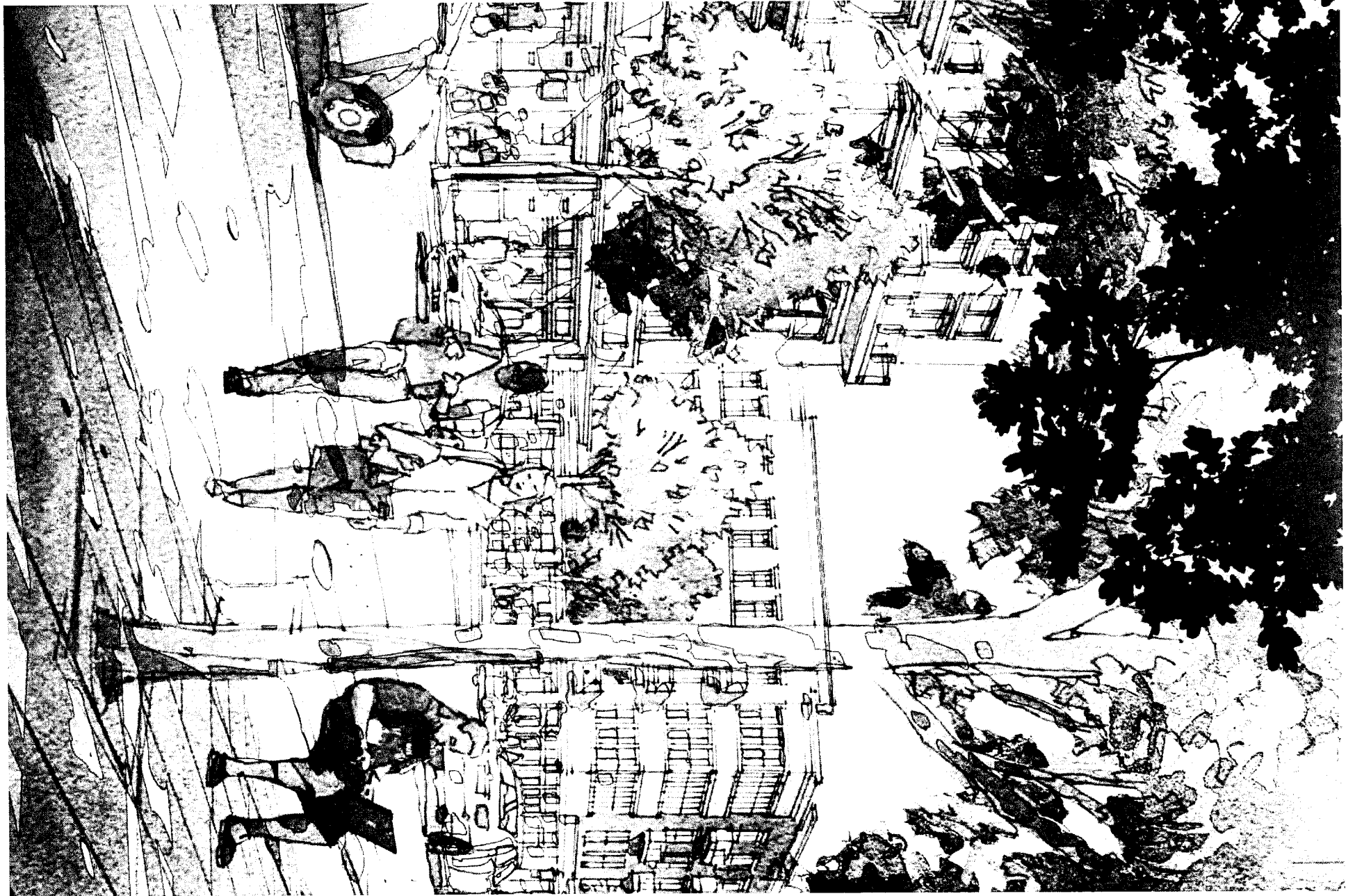

**WEST FARM/SOUTH FARM
PLAN SUMMARY**

WEST FARM/SOUTH FARM MASTER PLAN

The West Farm/South Farm Development Master Plan is a dramatic new mixed-use development in western Omaha, offering a rich and diverse life-style for residents, office workers, and visitors. The plan integrates many aspects of life into a compact, walkable village with safe, comfortable, and interesting streets, parks, and activities. The West Farm/South Farm Master Plan includes 1,330,00 SF of office; 845,000 of retail; 1,600 multi-family units; 150 townhouses; and 290 single family units.

MIXED-USE DISTRICTS

The core of the project located in West Farm is a pleasant shopping and dining district with a wide selection of restaurants and retailers. For those who love urban life, upstairs apartments and office lofts will further animate the center. A shopping center for fashion and home furnishing retailers is located in the northern area near Dodge within easy walking distance of nearby offices and the core. South of Pacific is a neighborhood oriented shopping and office district with a major grocer, restaurants, and shops. Nearly one-third of the land development area is devoted to outdoor activities, trails, and recreation. Two large civic parks, a village square, family-oriented neighborhood parks, and a continuous trail looping the site, will offer a healthy lifestyle for residents and office workers. The mixed use district for South Farm is more fully described later in this volume.

RESIDENTIAL NEIGHBORHOODS

Residential neighborhoods here are different in that they are based on Omaha's finest most walkable neighborhoods from the early 20th century. The houses will be modeled after Omaha's great Tudor, Craftsman, and Colonial houses. There will be no streets lined with garage doors. Garages will be alley loaded, and streets instead will be lined with porches, authentic facades, and gardens. Residential districts are more fully described in the West Farm/South Farm Master Plan.

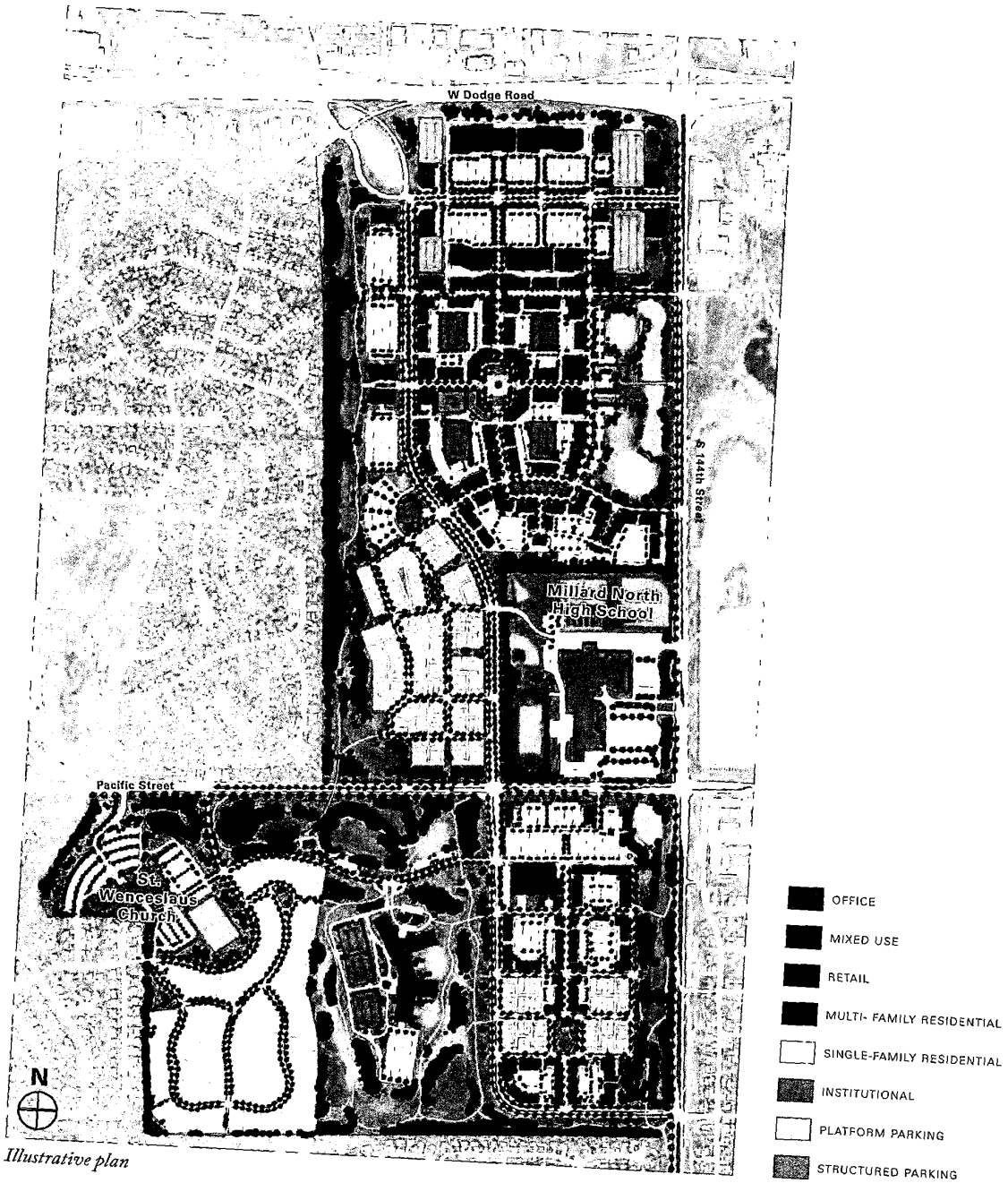

Illustrative plan

DESIGN AND DEVELOPMENT PRINCIPLES

West Farm/South Farm presents a unique opportunity for enriching western Omaha with a new mixed-use walkable development consisting of several neighborhoods and districts. The following design and development principles were followed in the design process.

DESIGN AND DEVELOPMENT PRINCIPLES
<p>1. CREATE A 24/7 PEDESTRIAN-FRIENDLY ENVIRONMENT</p> <ul style="list-style-type: none"> » Build compact pedestrian friendly mixed-use neighborhoods » Locate many activities of daily living within walking distance » Build interconnected streets to encourage walking and to reduce the number and length of automobile trips, and conserve energy. » Build trails that provide pleasant walking and biking routes connecting to all neighborhoods and adjacent communities. <p>2. PROVIDE A MIX OF USES</p> <ul style="list-style-type: none"> » Office Park » Mixed-use commercial center with retail, residential, and office » Apartment neighborhoods » Single-family neighborhood » Corporate campus for Applied Underwriters » Neighborhood shopping district » Civic parks » Extensive trail network <p>3. PROVIDE A RANGE OF HOUSING CHOICES</p> <ul style="list-style-type: none"> » Urban center apartments and condominiums » Apartment communities » Mansion apartments » Townhouses » Urban single-family houses » Large houses and mansions <p>4. CREATE A UNIQUE RANGE OF PUBLIC SPACES</p> <ul style="list-style-type: none"> » Gateway park with an amphitheater and lake » Farm-to-table garden and dining district » Public square » Residential neighborhood parks » Ravines and natural areas » Trails <p>5. PROVIDE SHARED PARKING AREAS SCREENED FROM PUBLIC STREETS</p> <p>6. DESIGN URBAN BUILDINGS</p> <ul style="list-style-type: none"> » Buildings should define streets and public spaces as places of shared use » Commercial buildings should animate and enrich public streets » Houses should be designed based on Omaha’s great residential neighborhoods with beautiful facades, porches, and landscaping — no garage doors facing the street

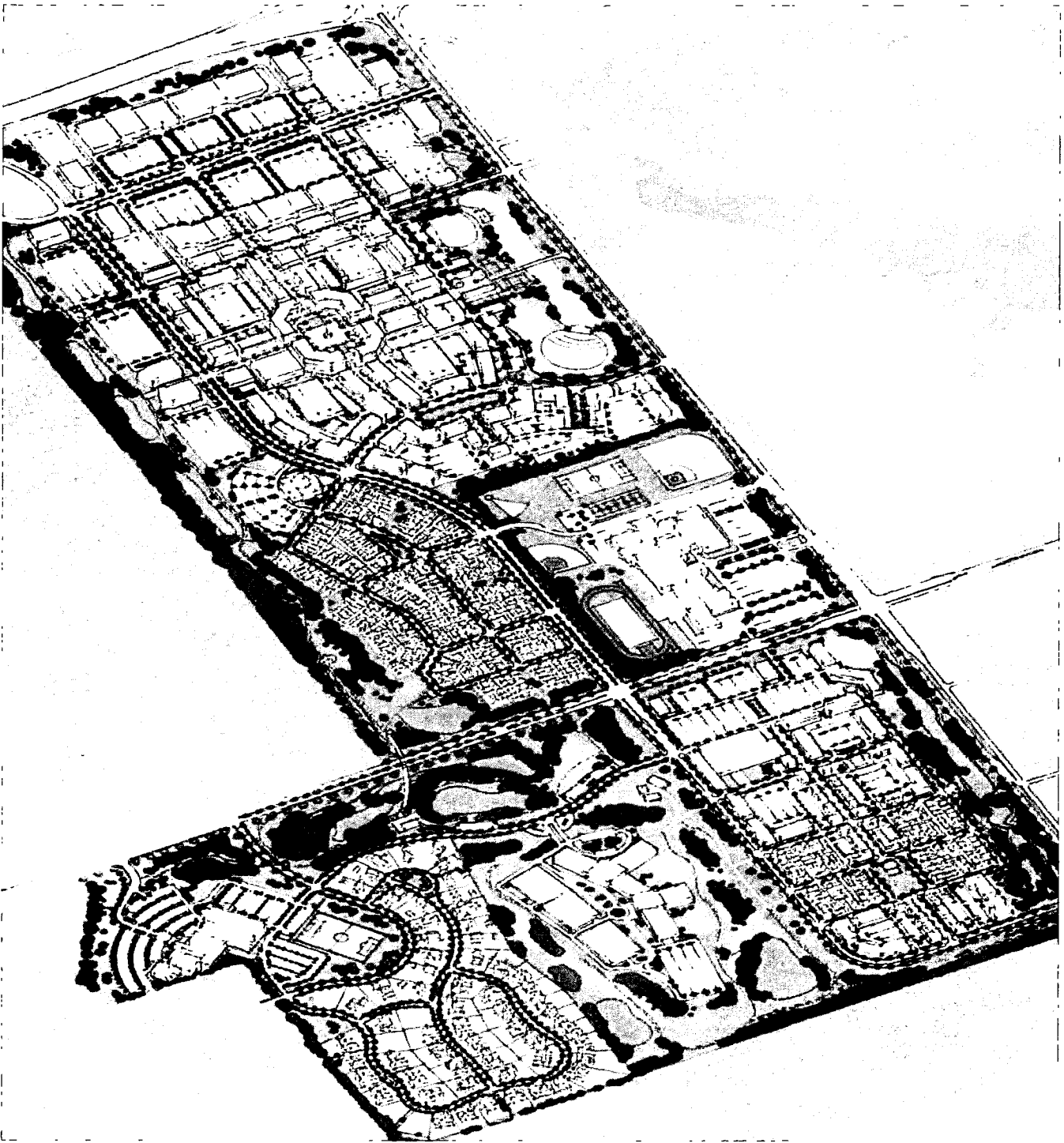



SOUTH FARM MASTER PLAN

SUMMARY OF SOUTH FARM MASTER PLAN

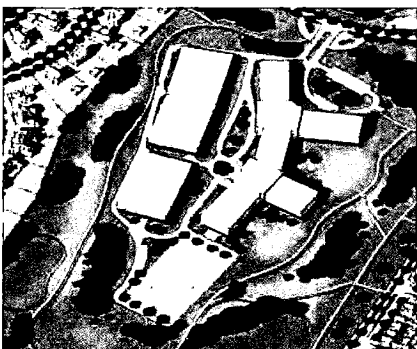
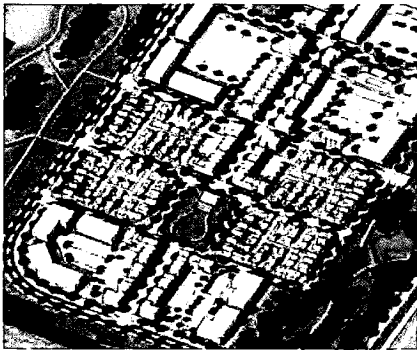

The South Farm Master Plan is a dramatic new mixed-use development in western Omaha, offering a rich and diverse lifestyle for residents, office workers, and visitors. The plan integrates many aspects of life into a compact, walkable village with safe, comfortable, and interesting streets, parks, and activities.

MIXED USE DISTRICTS

The core of the project located in South Farm is a pleasant neighborhood retail district with a grocery store anchor and neighborhood-serving retail. The district includes offices above ground floor retail, office buildings, and apartments in a variety of formats.

South Farm will be home to the new Applied Underwriters corporate campus, situated on a hilltop visible from Pacific and surrounded by greenways and trails.

Nearly one-third of the land development area is devoted to outdoor activities, trails, and recreation. A large central recreation area, a village square, family-oriented neighborhood squares, and a continuous trail looping the site, will offer a healthy lifestyle for residents and office workers. Mixed-use districts are more fully described in the next section.

RESIDENTIAL NEIGHBORHOODS

There are two distinct residential neighborhoods in South Farm, a village of small single-family houses, townhouses and apartments, and an exclusive neighborhood of large lot estate homes. Residential neighborhoods here are different in that they are based on Omaha's finest most walkable neighborhoods from the early 20th century. The houses will be modeled after Omaha's great Tudor, Craftsman, and Colonial houses. Residential Districts are more fully described in the West Farm/South Farm Master Plan Volume.

South Farm Master Plan Development Quantities

District	Office (SF)	Retail (SF)	Institutions (SF)	Multi-Family (Units)	Townhouse (Units)	Single Family (Units)
Residential	—	—	—	186	68	128
Mixed-Use	458,800	165,980	7,700	135	51	—
Total	458,800	165,980	7,700	321	119	128

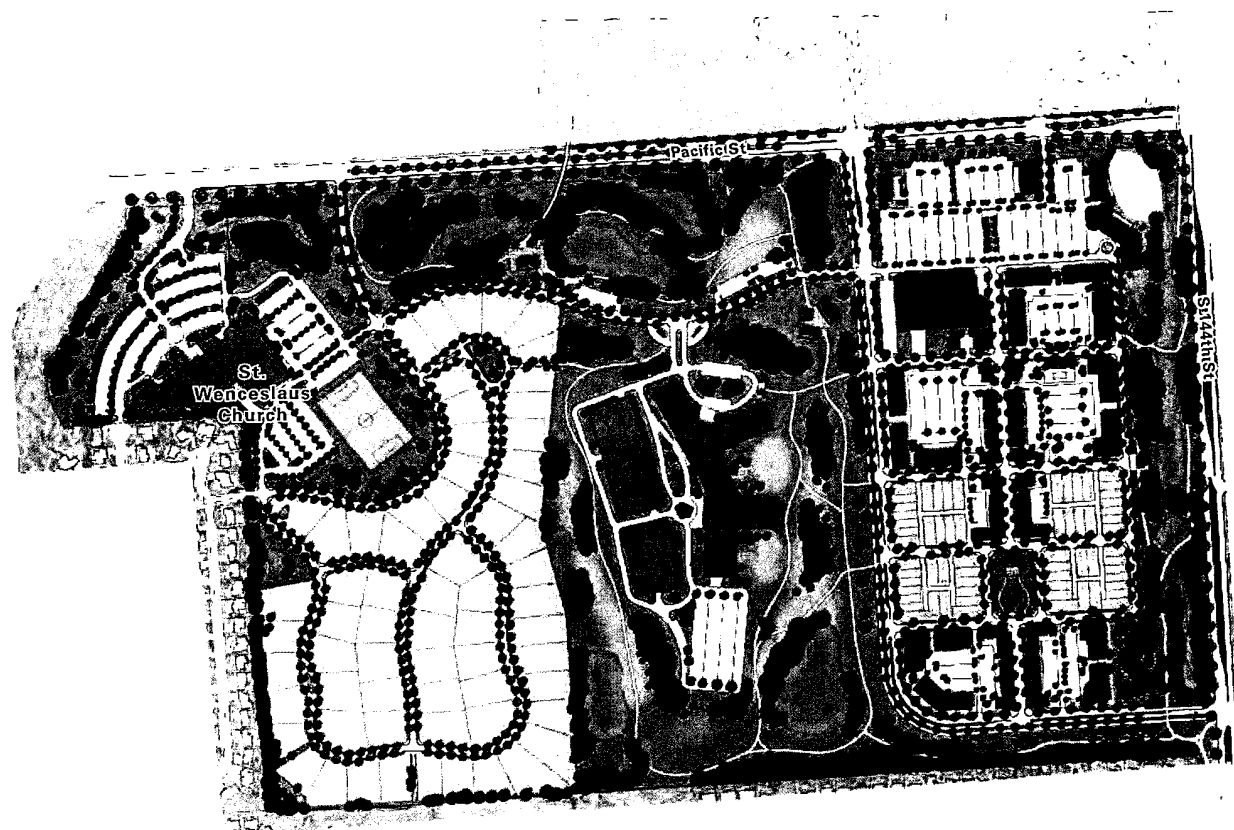

Illustrative Plan



SOUTH FARM





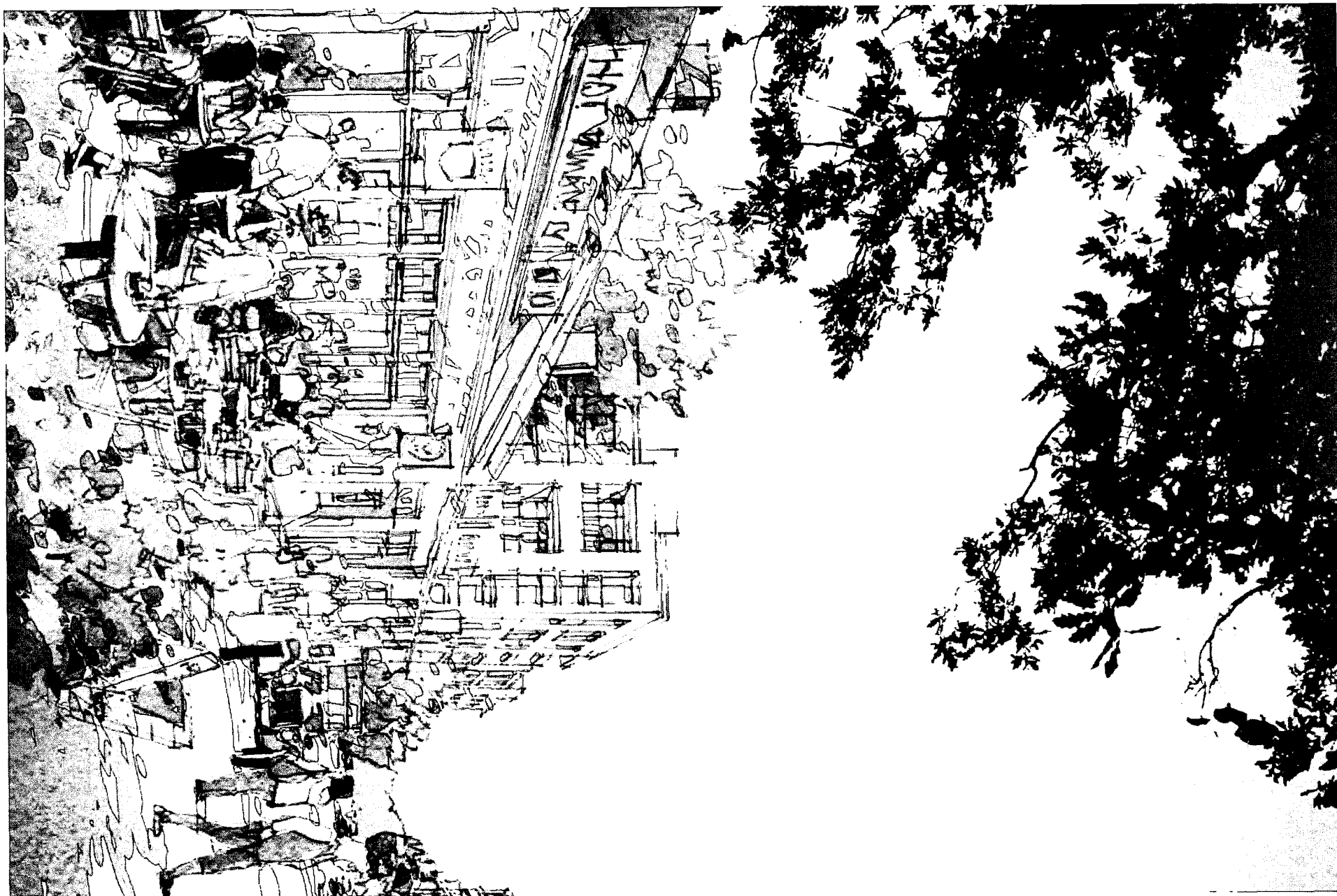

**SOUTH FARM MIXED-USE
DEVELOPMENT PLAN**

LAND USE PLAN

The Land Use Plan consists of two types of land use districts: Mixed-Use and Residential. Both land use categories are found in South Farm as shown on the adjacent plan.

MIXED USE DISTRICT

The Mixed-Use District includes open space, the parkway, and streets serving the district, 458,000 SF of office; 166,000 SF of retail; 135 multi-family units; 51 townhouses, and institutional uses.

RESIDENTIAL DISTRICTS

Residential Districts include residential open space, streets serving residential units, multi-family and single family residential development. They are more fully described in the West Farm/South Farm Master Plan.

South Farm Mixed-Use Development Quantities

Block	Office (SF)	Retail (SF)	Multi-family (Units)	Townhouses (Units)	Institutional
D1	—	—	—	—	Existing
D2	—	—	—	—	—
D3	—	5,000	—	—	—
D4	—	7,000	—	—	—
D5	—	79,980	79	—	—
D6	—	74,000	—	3	—
D7	32,400	—	30	24	—
D8	26,400	—	26	24	2,700
D16	400,000	—	—	—	5,000
Total	458,800	165,980	135	51	7,700

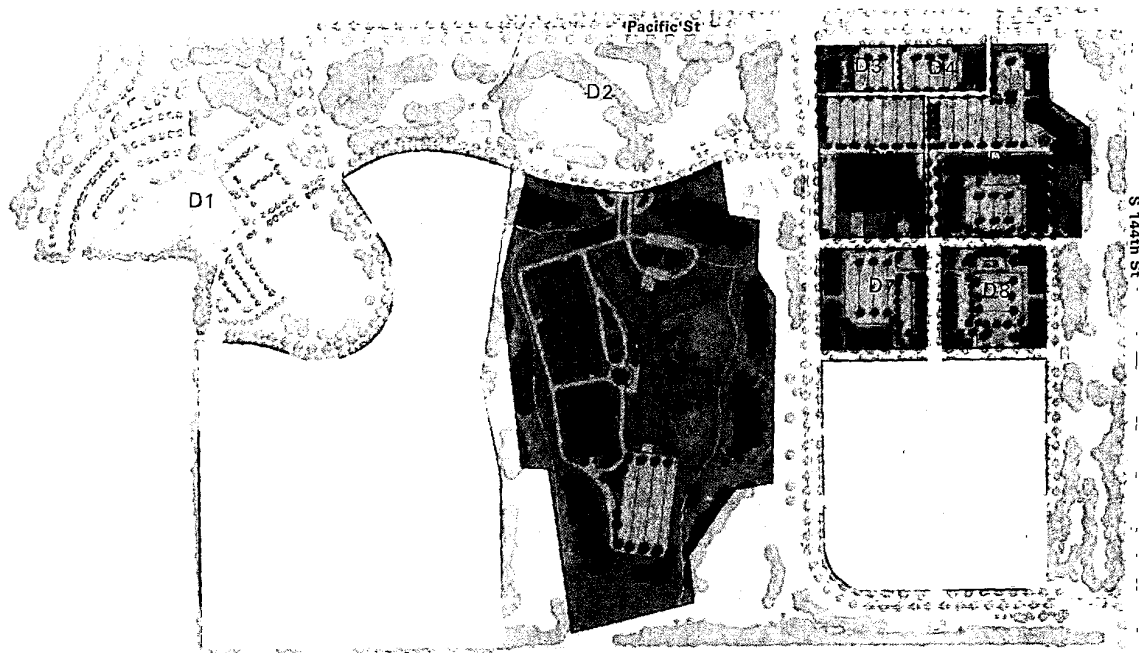

Land Use Diagram

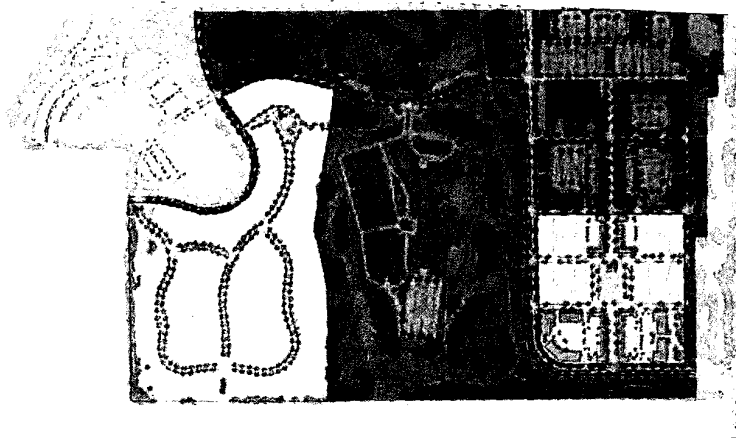

- MIXED-USE DISTRICT
- RESIDENTIAL DISTRICT

MASSING DIAGRAMS

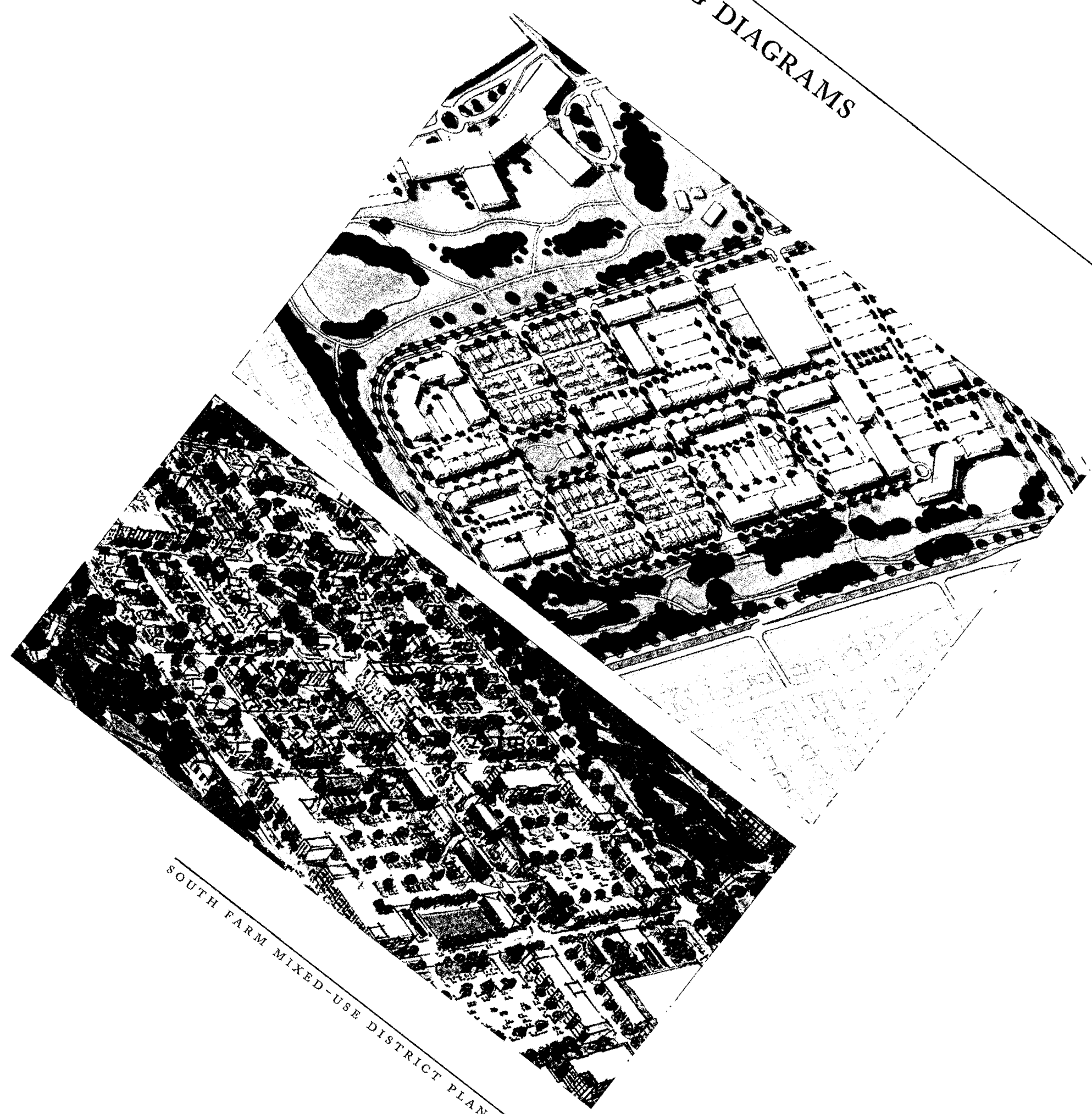

SOUTH FARM MIXED-USE DISTRICT PLAN



LANDMARKS, FOCAL POINTS, AND AXES



Omaha has a rich tradition of supporting local artists



Existing landmarks on site

The townscape of South Farm is designed to take advantage of key view corridors and points of convergence.

GATEWAYS

Major approaches to South Farm from Pacific will have gateway landmarks to announce entry. These may include signs, pavilions, works of art, and special landscapes. Buildings at prominent entries should be designed with corner features and interesting roofscapes to further animate the entry experience.

AXIS

View corridors orient visitors to key destinations and animate their experience with visual cues. A north/south view corridor in the South Farm village links the residential community to the neighborhood retail center.

LANDMARKS

Landmarks include highly visible buildings, pavilions, sculptures, signage, and fountains that terminate view corridors or dominate places. The corner of 144th and Pacific will be an opportunity for a landmark feature as well as the intersection of Pacific and the Parkway.



Perspective showing the neighborhood recreation area on the north/south axis.

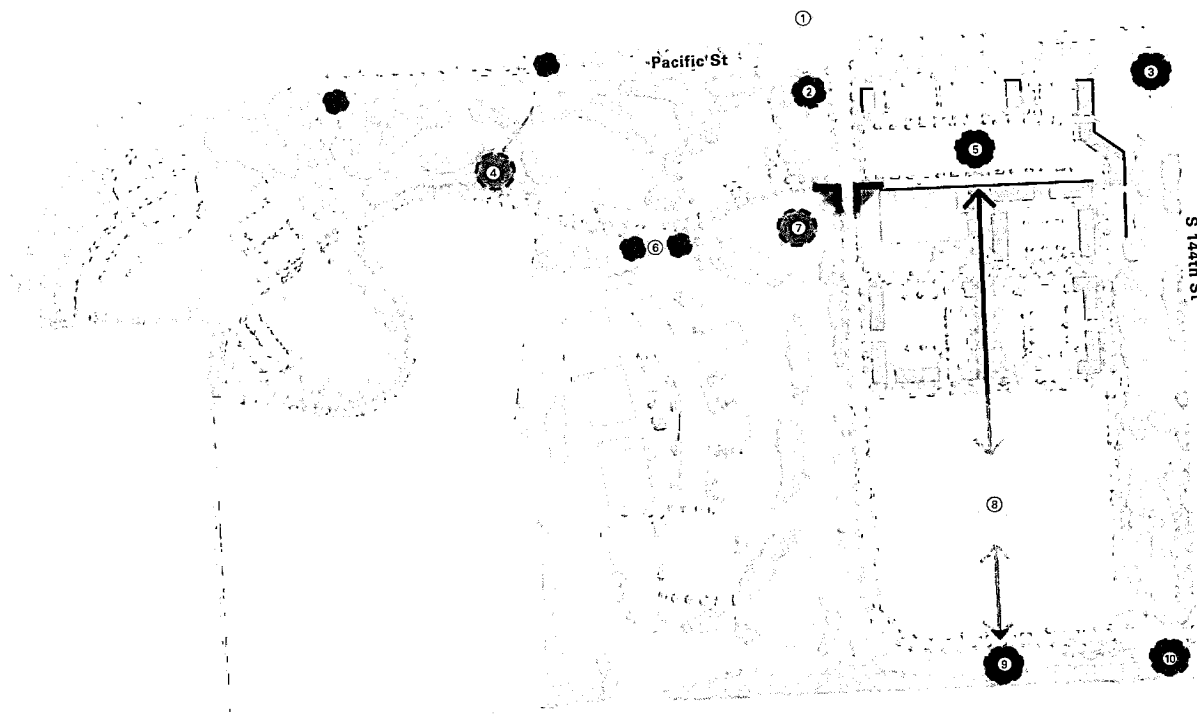

Landmarks, Focal Points, and Axes Diagram

- 1 Signage
- 2 Signage
- 3 Public Art/Signage
- 4 Pavilion
- 5 Signage
- 6 Office Gateway
- 7 Trail Head
- 8 Public Art
- 9 Pavilion
- 10 Signage

- GATEWAY LANDMARK
- HIDDEN TREASURES
- LANDMARKS TERMINATING AXES
- IMPORTANT CORNERS
- MAJOR AXIS
- VISIBLE FROM DODGE OR 144TH

OPEN SPACE SYSTEM



Neighborhood Square

South Farm will have a rich variety of open spaces that comprise approximately one-third of the total land area of the property. The greenways, recreation areas, and urban squares will add a unique dimension to life for residents and workers in the new development. The open space character will fall into three major categories.

GREENWAYS

These spaces are remnants of the agricultural lands and forested areas that buffer the development from adjacent districts and neighborhoods. These areas are used for trails and stormwater detention and are mostly passive in character.

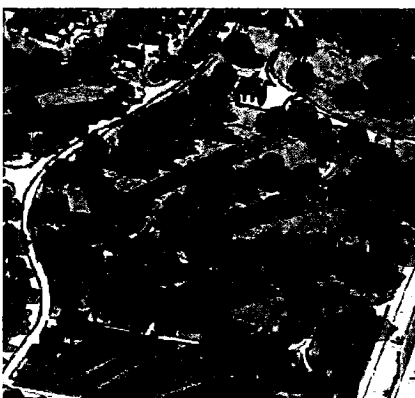

Pacific Recreation Area

RECREATION

These are highly programmed open spaces designed for passive daily use and special events such as festivals and concerts. Each recreation area will have a unique role in the life of the community. Pacific Area will be designed with informal recreational areas that can be programmed for special activities. The compact residential neighborhoods will have small recreation spaces with play areas designed for families and children.



Greenways

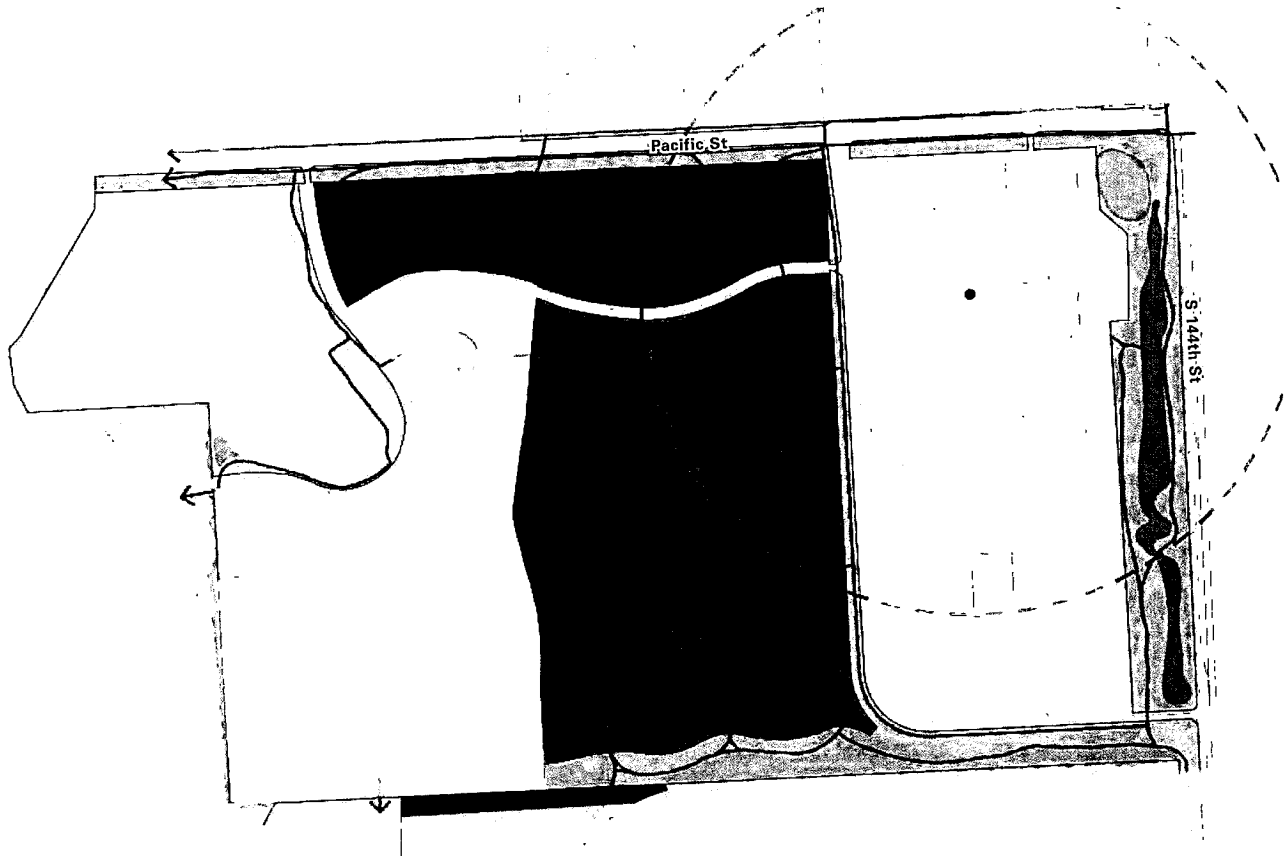

Open Space Diagram

- | | |
|---|---|
|  VILLAGE SQUARE |  CIVIC |
|  RECREATION AREA |  WATER FEATURE |
|  CAMPUS |  STORM WATER DETENTION |
|  NEIGHBORHOOD SQUARE |  TRAILS (10.9 MI) |
|  GREENWAYS |  5-MINUTE WALK |
|  GATEWAY | |

OPEN SPACES IN SOUTH FARM

Pacific Recreation Area

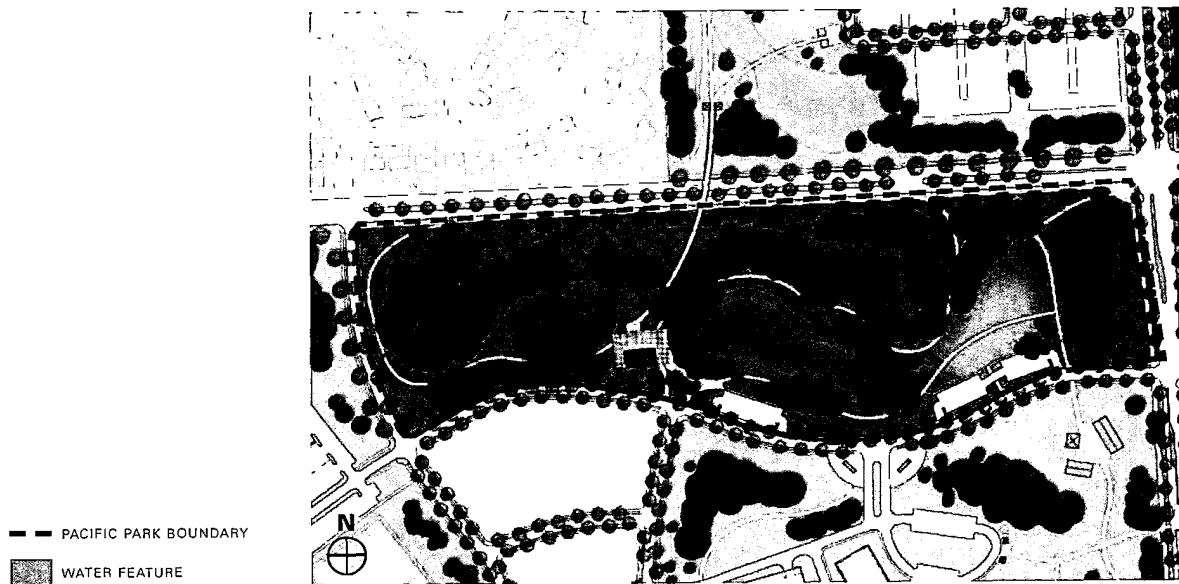



Greenways

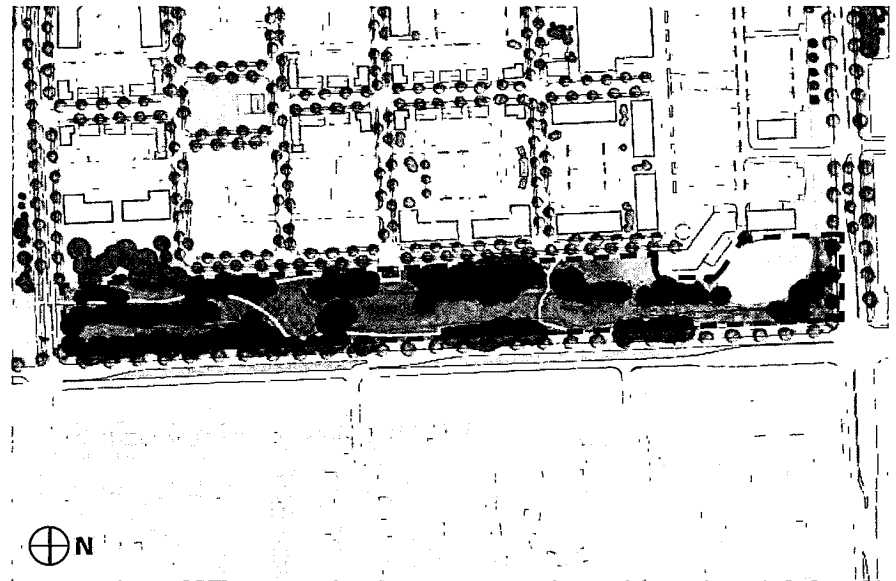

TRAIL SYSTEM



Multi-use trails will parallel streets.



Other trails will meander through natural areas.



Trails will connect residents and office workers with commercial centers.

One of the most distinguishing qualities of the South Farm plan is the extensive trail network that has been integrated into the design. The trail system will offer running, walk, and bike routes of differing lengths with an endless combination of distances. Trails are located to take advantage of the extensive open space system passing from one park and recreation area to the next. The trail network in West Farm/South Farm will connect to existing trails to the southern neighborhoods.

Multi-use trails will be integrated into the design of streets

DRAFT | 5 JAN 2017

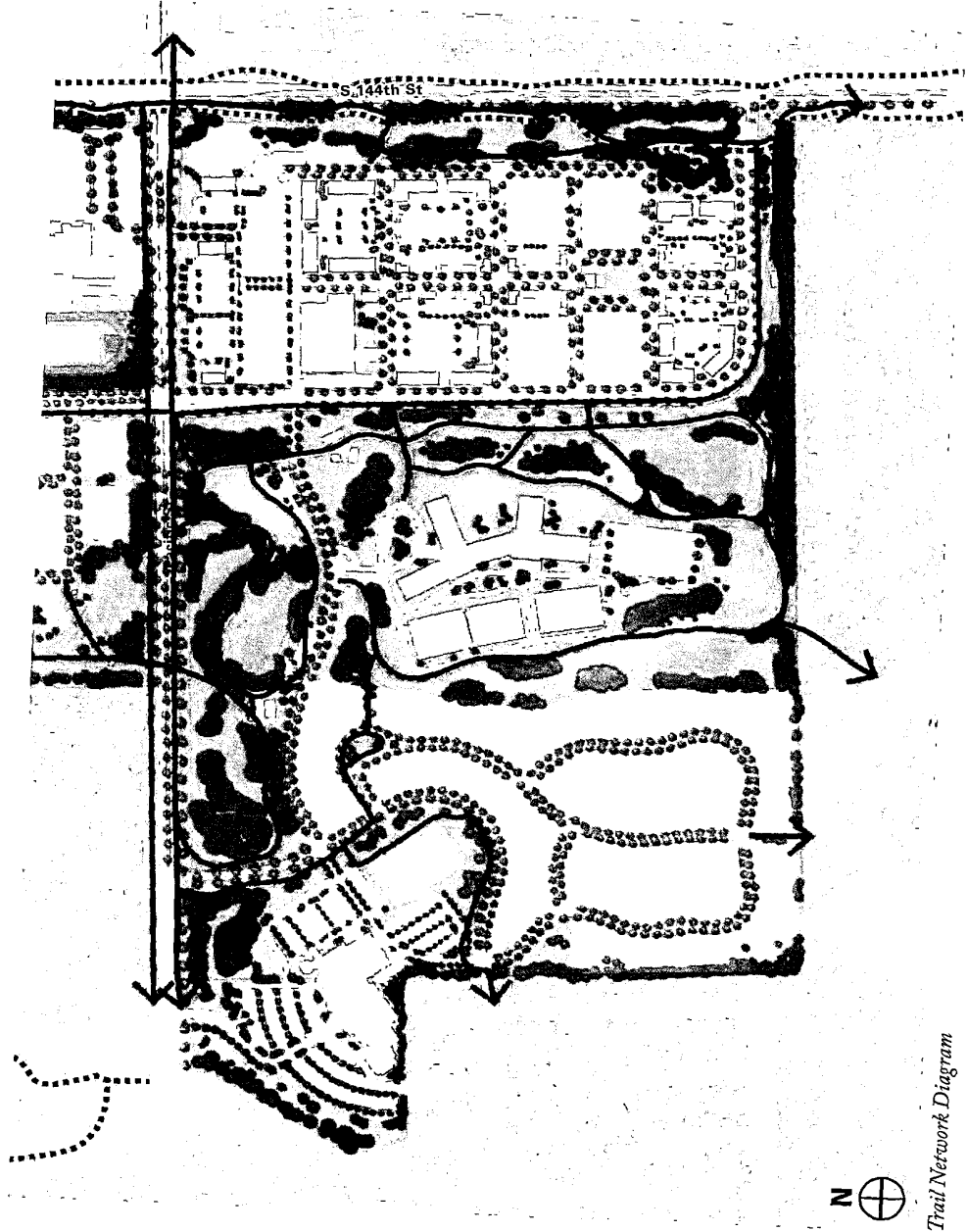

Trail Network Diagram

MIXED-USE DISTRICT STREETS



Perspective of new mixed-use street



Residential Street





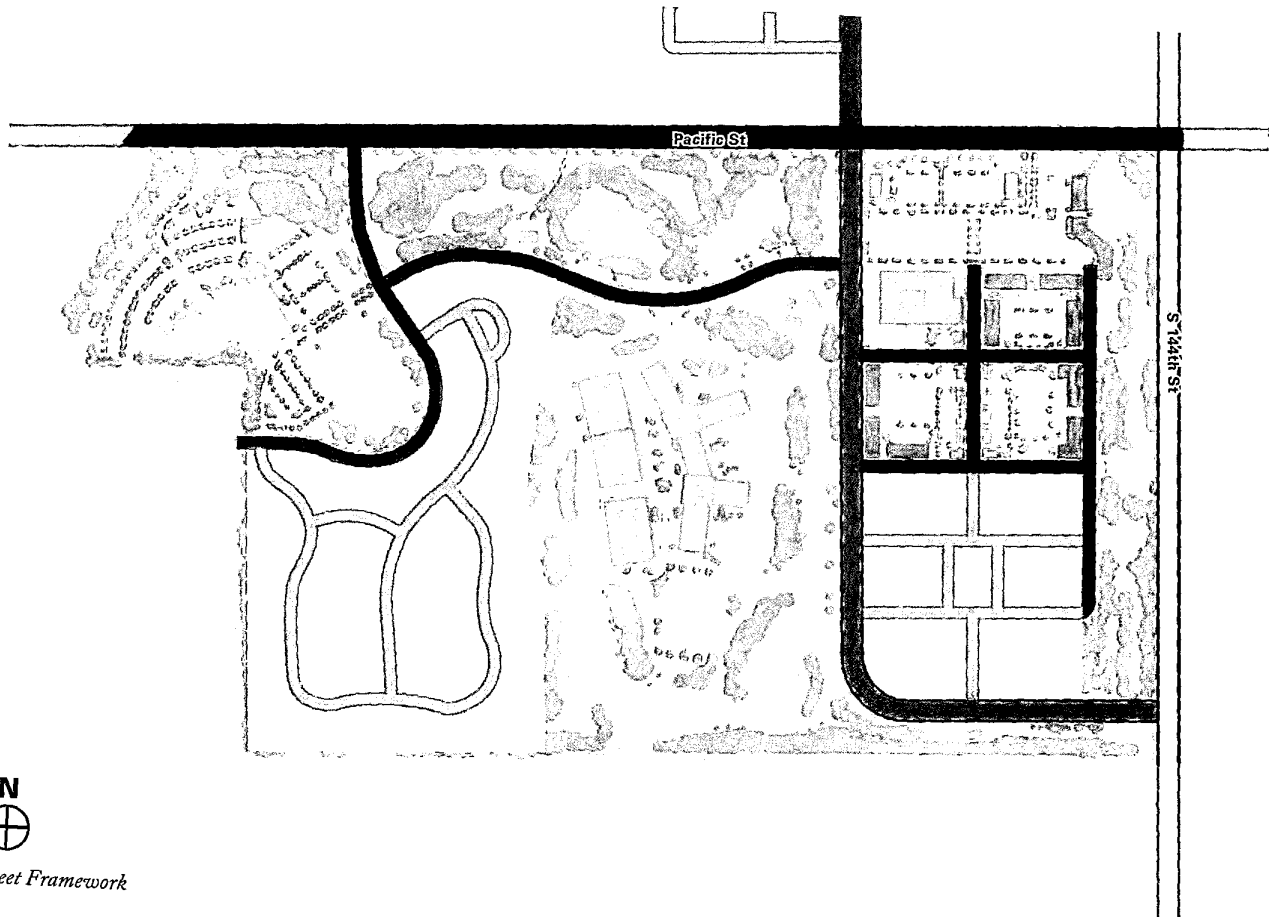

The street network in South Farm is organized into a grid pattern to provide motorists with many choices to navigate the site and to create walkable communities. New streets built on the South Farm property will contribute to overall mobility in western Omaha by expanding the street network and creating alternative routes. Considerable traffic currently uses Dodge, 144th, and Pacific for daily commuting and regional access. The development will add additional trips to the network but will also expand it. Improvements to existing intersections include the widening of 144th and Pacific. A new north/south parkway will parallel 144th connecting Pacific just west of Millard North High School south to 144th. New streets within the site will accommodate the traffic generated by the new development.

Street designs are influenced by the land uses they serve and are conceived as “complete streets.” These are streets designed as beautiful public spaces, with accommodation for motor vehicles, bicycles, pedestrians, street furniture, utilities, and landscaping. The development has the following street types:

- » 144th Street
- » Pacific Street
- » The Parkway
- » Mixed-Use Streets
- » Multi-Family District Streets
- » Residential Neighborhood Streets



N
⊕
Street Framework

-  SOUTH FARM BOULEVARD
-  MULTI-FAMILY STREETS
-  MIXED-USE STREET
-  RESIDENTIAL STREETS
-  RESIDENTIAL STREETS ADJACENT TO PARKS
-  PACIFIC STREET
-  144TH STREET

MIXED-USE DISTRICT STREETS

Parkway

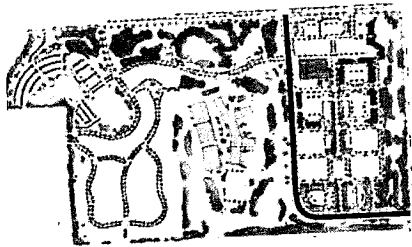

South Farm Boulevard is the major circulation spine for the South Farm development, extending from the intersection at Pacific Street west of Millard North High School and extending south to 144th. The boulevard is a “complete street,” designed with one travel lane in each direction and left turn lanes at intersection. West Farm Boulevard runs parallel to 144th and will distribute traffic to reduce congestion in the road network. It will provide access to the mixed use and residential districts.

The design includes a landscaped median and deep tree lawns (verges) between the roadway and pedestrian walks creating the impression of a continuous greenway. A 14-foot multi-use trail follows the Parkway the entire length for use by cyclists and pedestrians.

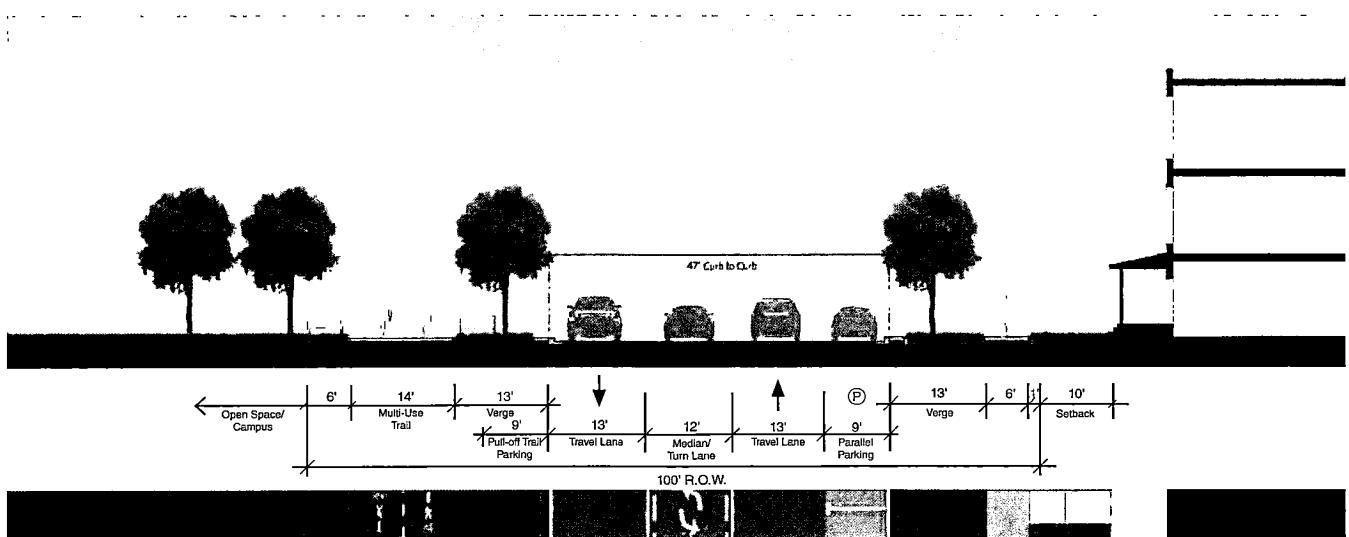

Street section for South Farm Boulevard



Retail Street Parallel Parking

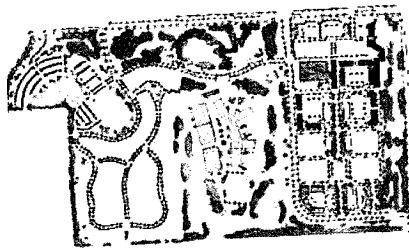

A majority of streets in the village center are two lane streets with parallel parking on both sides. The sidewalk are approximately 15 feet deep with areas for tree planting and pedestrian movement. In commercial areas, buildings are set back 10 feet to create a wider pedestrian realm for shopping and outdoor dining. The setback is an ideal location for outdoor cafes and retail displays. This area also permits overhanging signage, awnings, and balconies without protruding into the street right-of-way. The building face to face dimension is very similar to traditional shopping streets across the US.

In residential areas of the village center the 10-foot setback creates a front yard zone and place for the transition from sidewalk level to residential floor level.

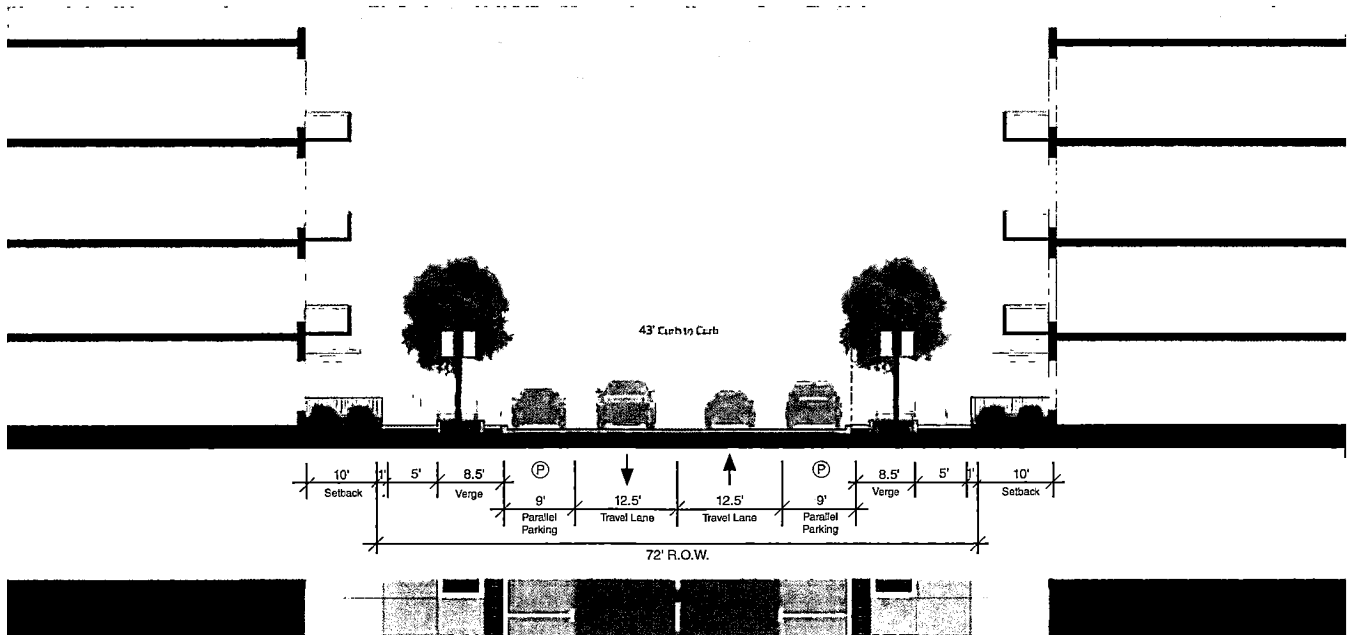

Street section for Commercial Streets with Parallel Parking

MIXED-USE DISTRICT STREETS

Multi-Family Street

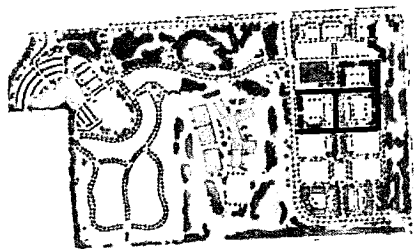

Apartment Areas South Farm will need easy access for a higher concentration of activity that would be found in single-family neighborhoods. Apartment streets are similar in design to Commercial streets but with more landscaping and less sidewalk area. On-street parking is provided for visitors and ground floor retail uses that may be found in apartment developments. Buildings are set back 10 feet from the street right of way line to create space for front yard landscaping to separate residential units from sidewalks. Trees are planted in continuous landscaped verges.

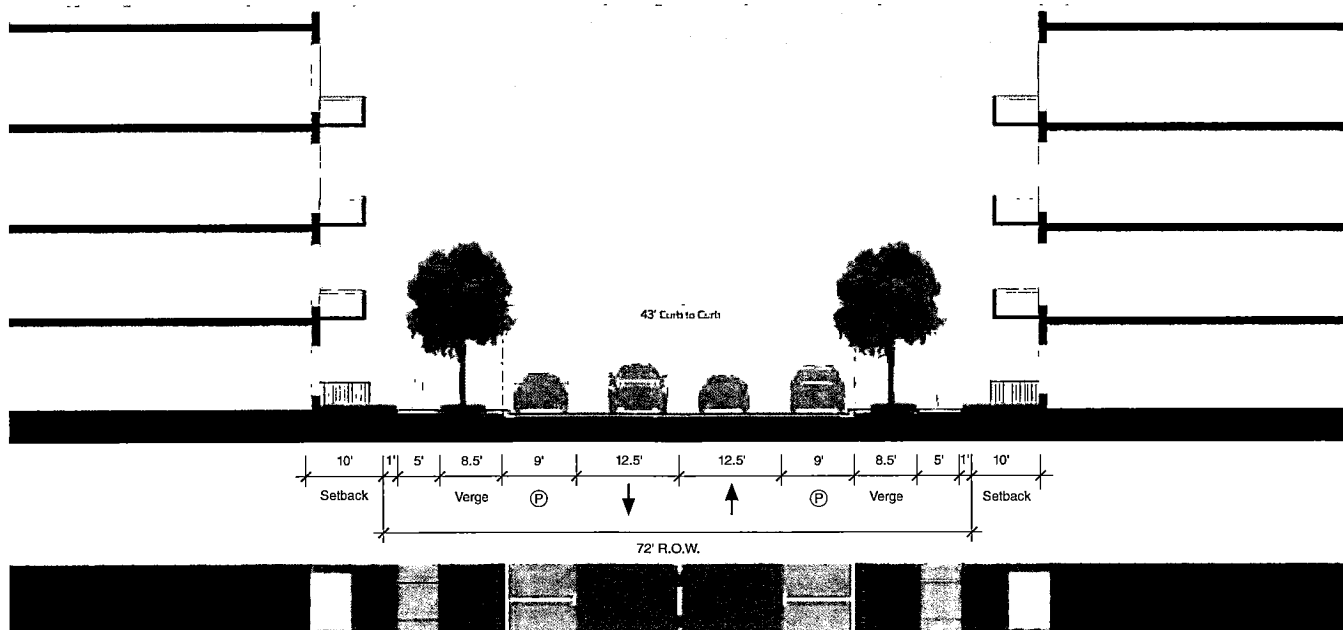

Street section for Apartment Streets

MIXED-USE DISTRICT STREETS

Service Alleys

South Farm is designed with service alleys that provide access to commercial and mixed-use buildings. Service lanes should be dimensioned to accommodate delivery trucks and emergency vehicles. They are also used to provide access to visitor and accessible parking spaces adjacent to buildings, parking lots and parking garages. Service alleys also provide space for utilities including electricity, cable, gas, and water taking pressure off of the street for routing these services. Each building will have utility service entries and space for garbage containers and delivery docks.

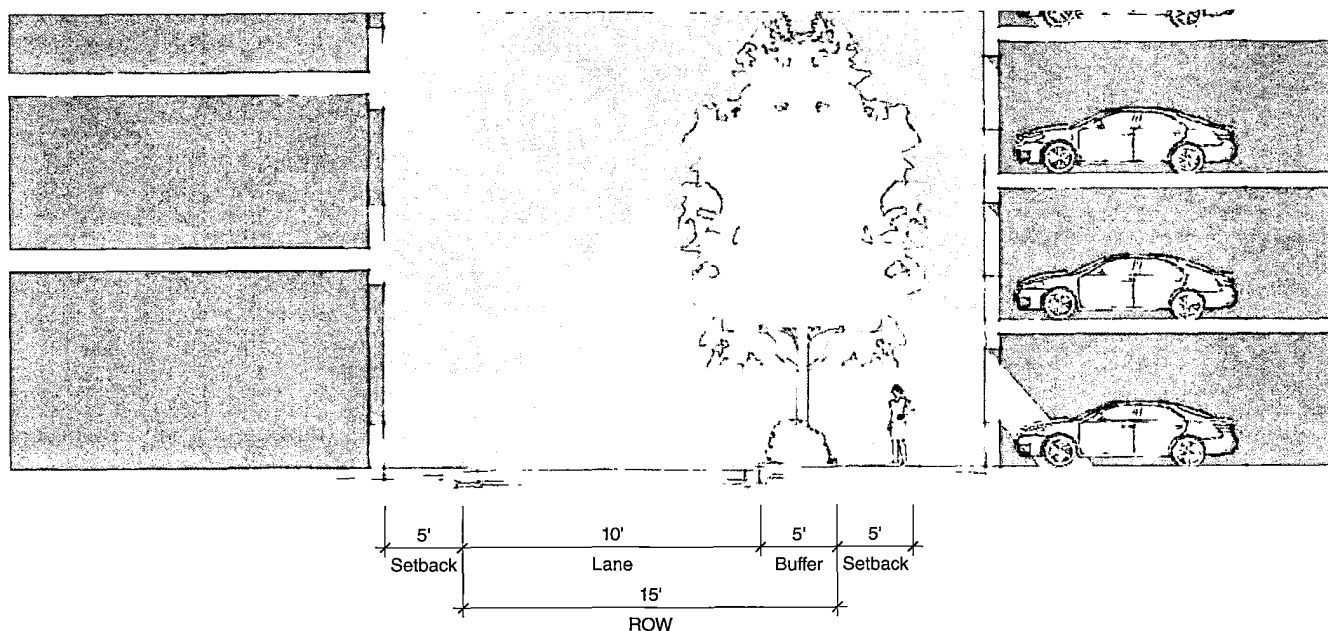

Street section for Service Lanes

BUILDING SETBACKS



Examples of Residential Setback



Examples of Residential Setback



Examples of Commercial Setback



Examples of Commercial Setback

Most building setbacks in West Farm/South Farm are 10 feet from the street right-of-way line. For commercial buildings, the 10-foot dimension is used in a couple of different ways. For office buildings without street related activity, a landscaped setback is recommended. For commercial and mixed-use buildings with active ground-floor uses connected to the street including retail offices, shops, and restaurants, the 10-foot setback provides additional sidewalk depth for outdoor retail, street signage, sidewalk cafes, and other outdoor activities. The setback provides space for elements that overhang the front facade of buildings including awnings, canopies, projecting signs, and balconies.

For houses, the setback is dimensioned to the front of the porch or the closest portion of the house facade. For apartment buildings, the setback is to the main building mass. In both single-family attached and detached buildings and apartment buildings, the 10-foot setback provides a front yard for landscaping and grade transitions. The first floor of residential buildings should always be set a couple of feet above sidewalk level to create additional privacy. Estate lot and mansion setbacks are a minimum of 20 feet.

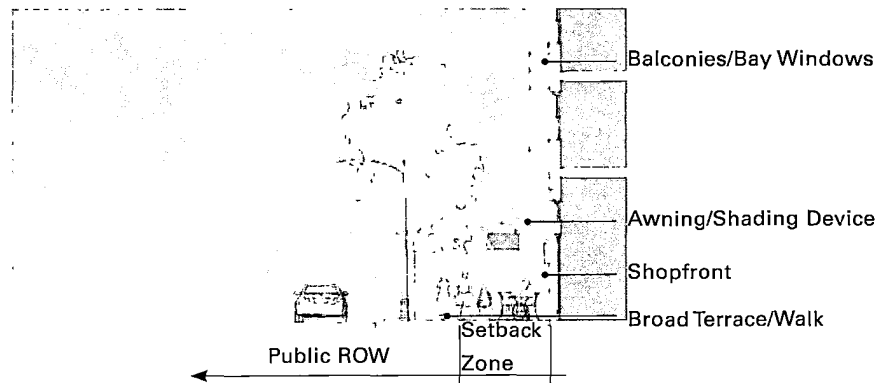

Commercial Setback Diagram

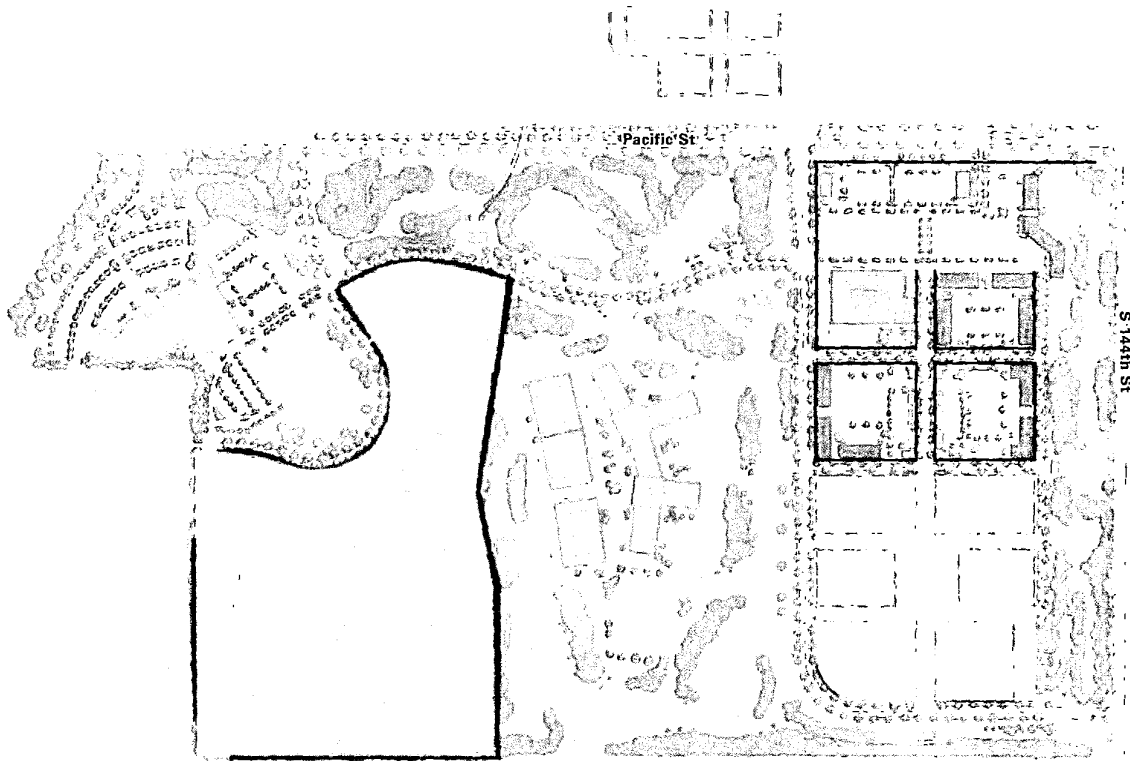

Building Setback Diagram

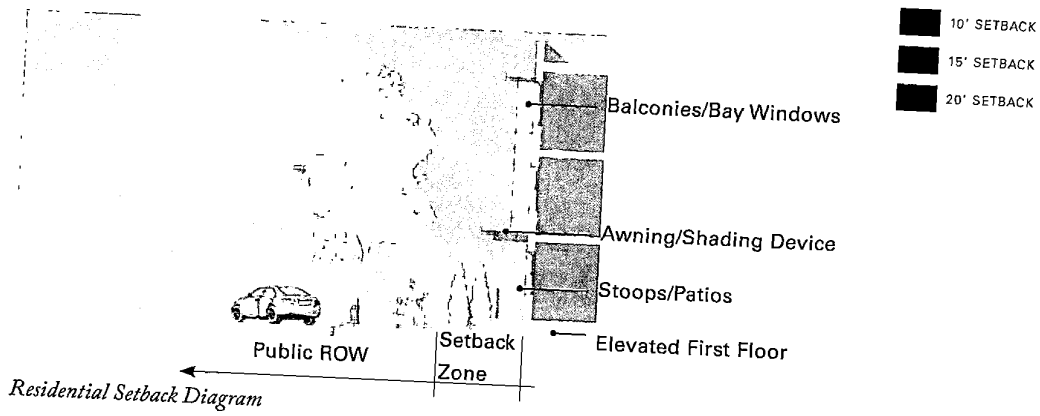

Residential Setback Diagram

ACCESS AND SERVICE



Example of appropriate screening with fencing



Example of appropriate screening with a structure



Example of appropriate screening with walls and landscaping

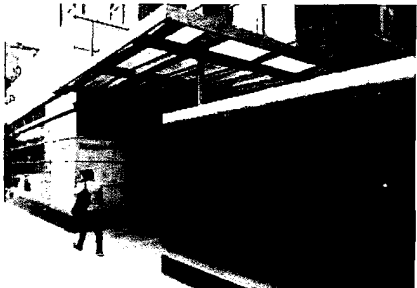

Example of appropriate screening with architectural walls

Service to all buildings should be located at the rear of the building in the middle of the blocks. One curb cut per block is permitted on all streets of less than 350 feet in length for access to service lanes, and two curb cuts for blocks longer than 350 feet.

Loading areas and dumpsters are required to be internal to the block and accessed by service lanes. No service doors shall face onto primary streets or parks. Loading docks, dumpsters, and building equipment should be screened from view with walls and landscaping. The service lanes and mid-block areas will be used for parking and accessible to the general public. These mid-block areas should be as attractive as they can be.

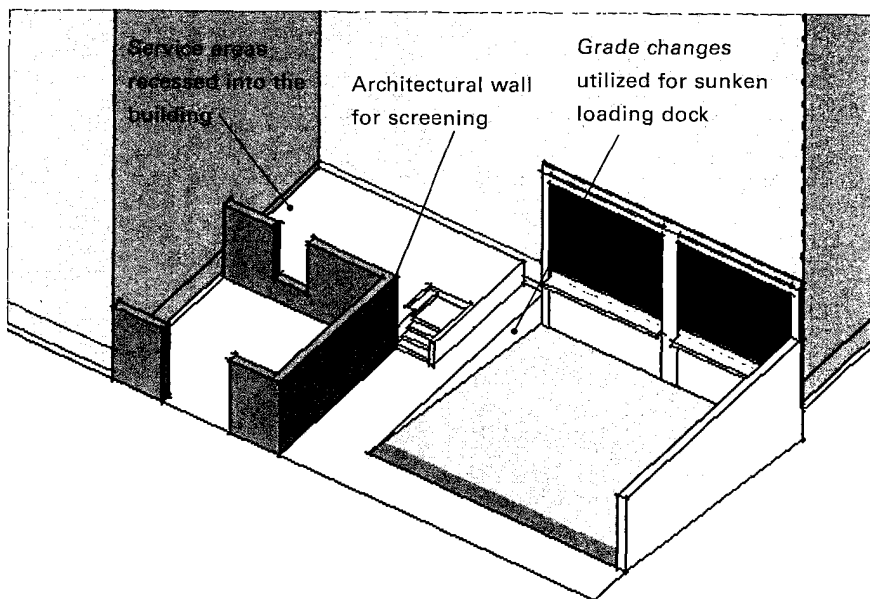

Appropriate service frontage diagram

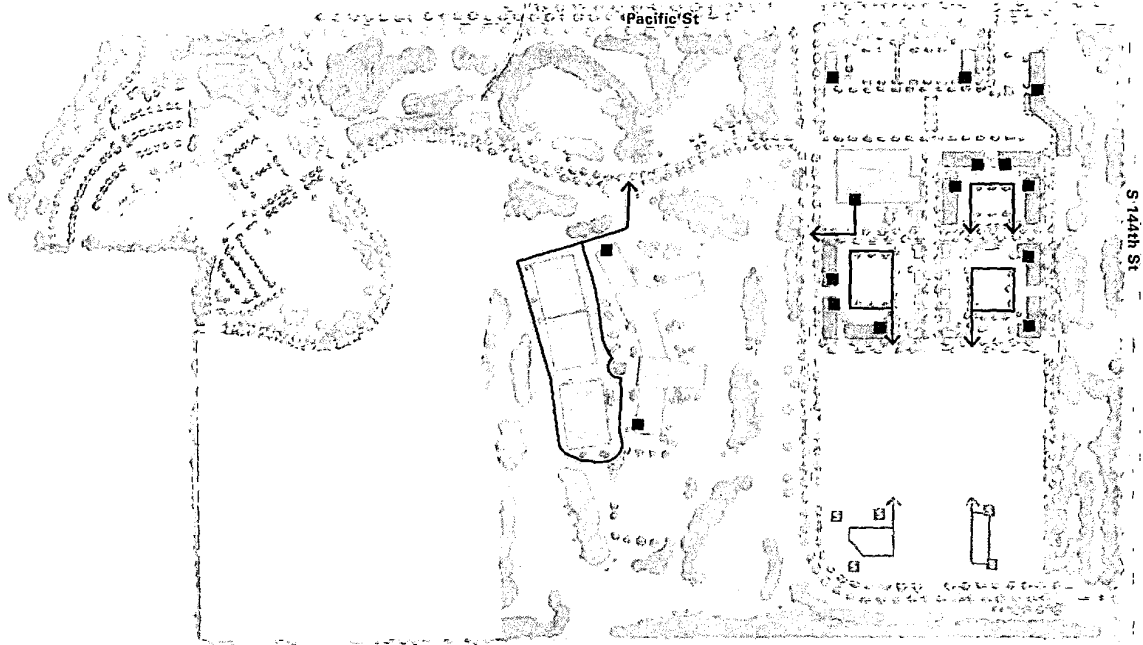

Access and Service Diagram

→ SERVICE ROUTE
S SERVICE AREA

PARKING

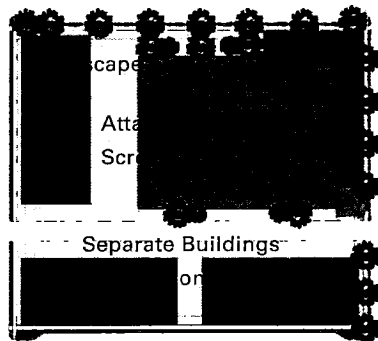
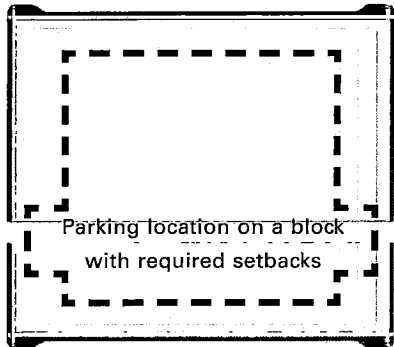

Ideally, parking is internally located on the block. Separate buildings, attached buildings, or landscaping should screen parking facilities from public streets and squares.

Parking is permitted in the middle of development blocks. The minimum setback for all parking is 10 feet. Parking lots should meet the landscaping standards required by the City of Omaha. Attractive passages and pedestrian connections should be provided between the mid-block parking area and streets. Much of the success of a retail district is the ease and attractiveness of parking and walking to shopping streets.

In some instances, parking garages will be required. Garages may be concealed with free standing street-oriented buildings or attached liner buildings. Access to garages for motorists and pedestrians should be clear and direct. Elevator lobbies should be highly visible and well illuminated at night.

Parking is not permitted inside buildings along street frontages at the ground floor. Street frontages must have active residential and commercial uses. Parking is permitted on the ground floor in the back.



Midblock parking garage with highly visible elevator lobbies and pedestrian entrance

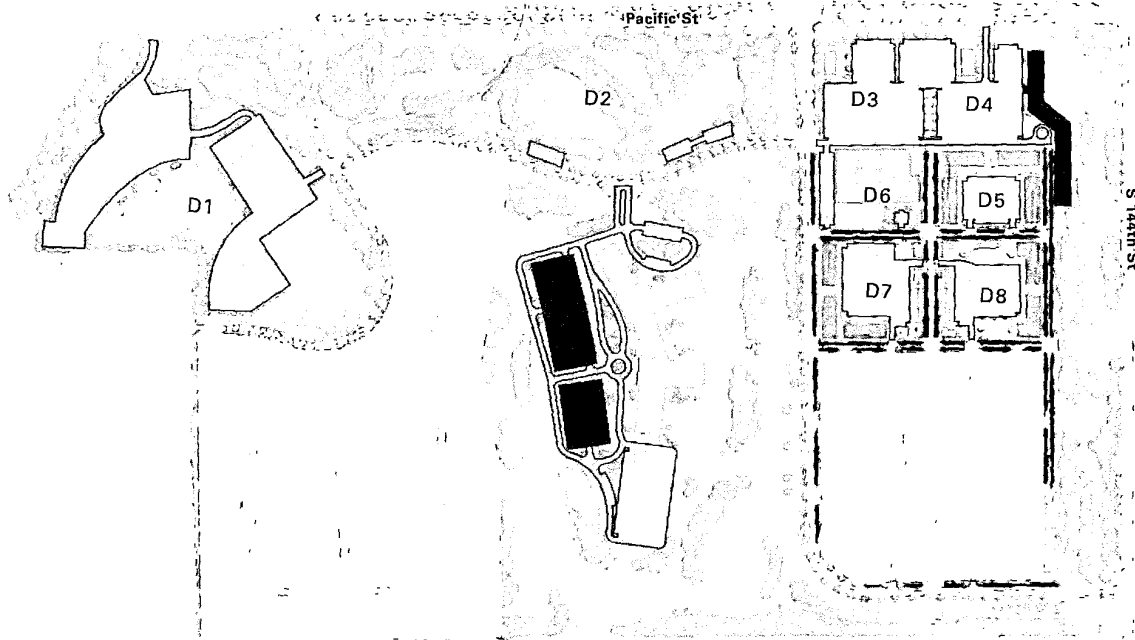

Parking Diagram

Block	On Street	Surface	Structured
West Farm South District			
D1	436	32	—
D2	—	76	—
D3	112	—	—
D4	148	—	—
D5	458	—	104
D6	308	39	—
D7	230	74	—
D8	178	68	—
Totals	1,870	289	104

- ON-STREET PARKING
- SURFACE LOT
- SINGLE LEVEL PARKING DECK
- PARKING GARAGE

BUILDING TYPES

Retail, Mixed-Use, Office

Commercial buildings include single-story retail buildings, multi-story buildings with ground floor retail and upper floor offices, and office buildings. In most instances, these buildings will be located fronting a street and will contribute towards making an important public space. Commercial buildings should be lively, attractive, and inviting. They may include storefronts, commercial signage, canopies, awnings, and large windows for transparency and openness. The ground floor of commercial buildings facing the street must be occupied space (active uses such as retail and office). Parking is not permitted within 20 feet of the street at the ground floor. Rear “tuck-under” parking is permitted.



Mixed Use



Mixed Use

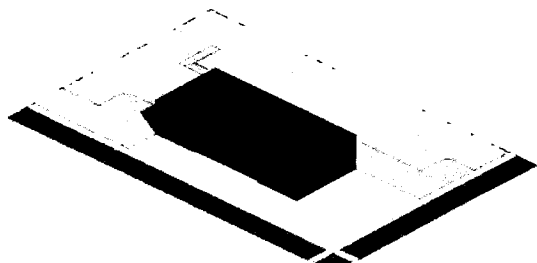

Retail



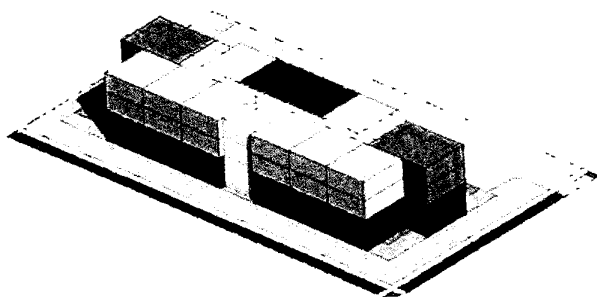

Mixed Use

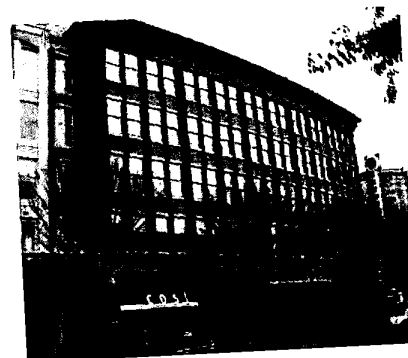
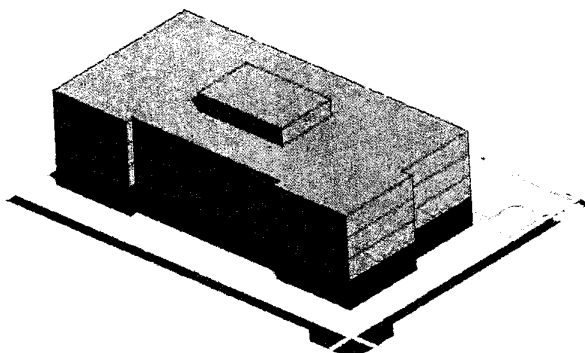

Office over Retail

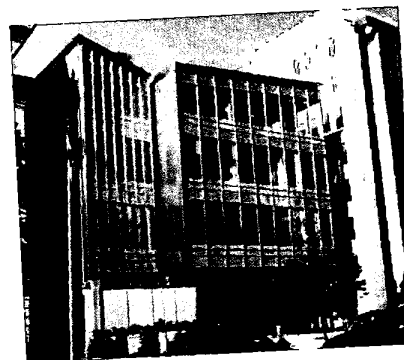
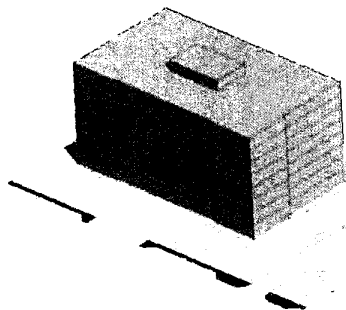

Office

BUILDING TYPES

Multi-Family Housing

Multi-family Housing includes the following building types:

APARTMENT BUILDINGS

Conventional apartment units with corridor access and surface parking mid-block

SOFT LOFT BUILDINGS

Urban loft units with taller floor to floor heights and loft finishes

MAISONETTE BUILDINGS

Multi-unit building with ground floor units accessed from the street with surface and/or tuck under parking

MANSION APARTMENT BUILDINGS

Small apartment buildings that appear like large houses

The ground floor of the multi-family housing facing the street must be residential units or amenities. Parking is not permitted within 20 feet of the street on the ground floor. Rear “tuck-under” parking is permitted. “Podium buildings” with parking filling the whole ground floor and apartments above are prohibited.

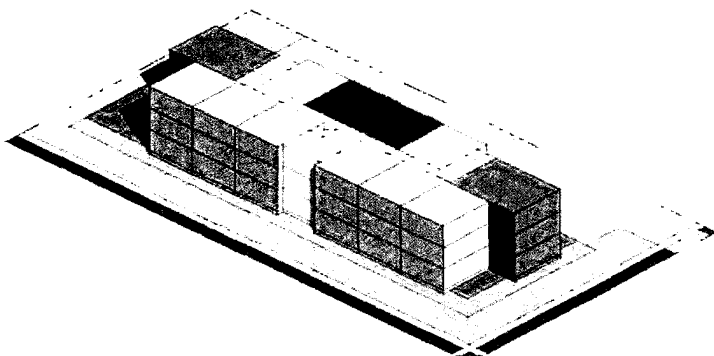

TYPICAL APARTMENT BUILDING

May range from 3–5 stories with 10-foot floor-to-floor heights.



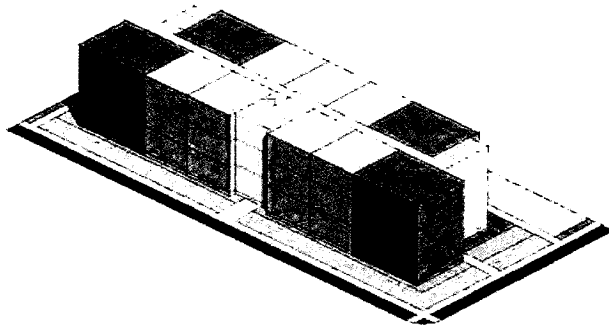

SOFT LOFT BUILDING

Taller floor to floor heights allow for loft units with mezzanines. These buildings may range from 2–8 stories.

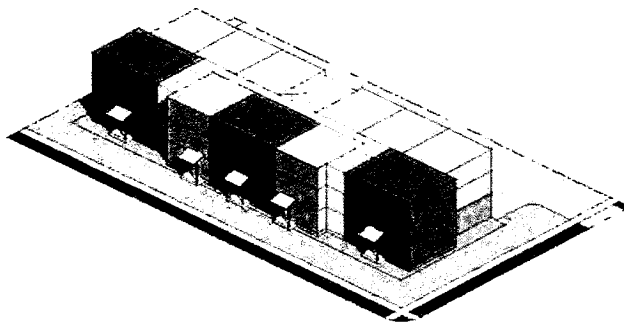
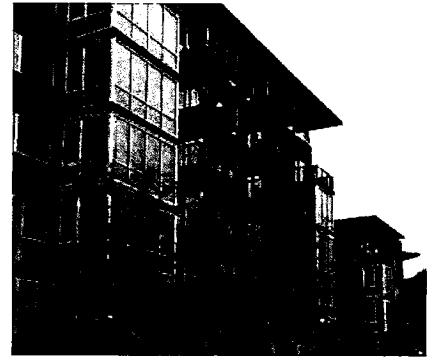

MAISONETTE BUILDING

Ground floor units are access from stoops on the street. Tuck-under parking is encourage in the rear of the ground floor.

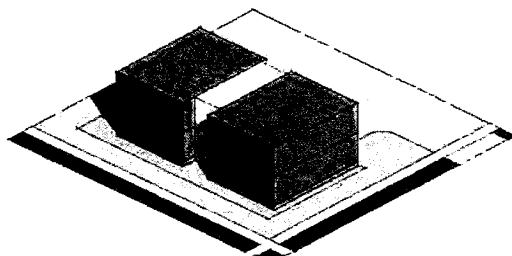

MANSSION APARTMENT BUILDING

4–6 units are accessed from shared central stair. These range from 2–3 stories.



BUILDING TYPES

Attached Housing

Attached houses are two or more single family houses that share a common wall. Three forms of attached housing are included in the master plan.

CORNER DUPLEX

Two townhouses are attached and located on a corner to resemble a large house with a main body and attached wing. Each unit has a separate entrance and porch. These are attractive on corners because each street has a facing house at the intersection.

MODIFIED TOWNHOUSES

These buildings consist of individual houses attached with single story garage structures. They look like separate houses from the street even though they are joined. These units are great for shallow lots where there is not enough backyard space for parking and outdoor activities.

TOWNHOUSES

These are single-family houses of two or three stories in height that share common walls. They come in many different widths and plan configurations.

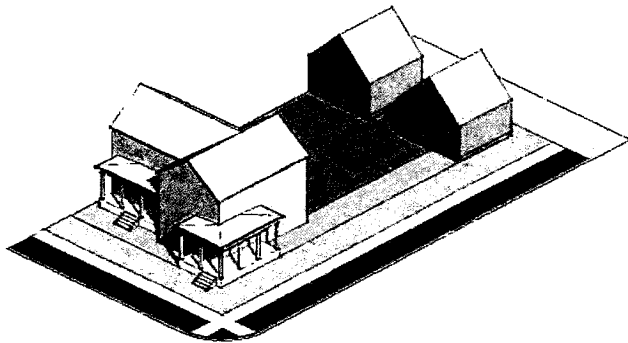

CORNER DUPLEX

Articulated as a large house with two fronts, making it ideal for corner lots

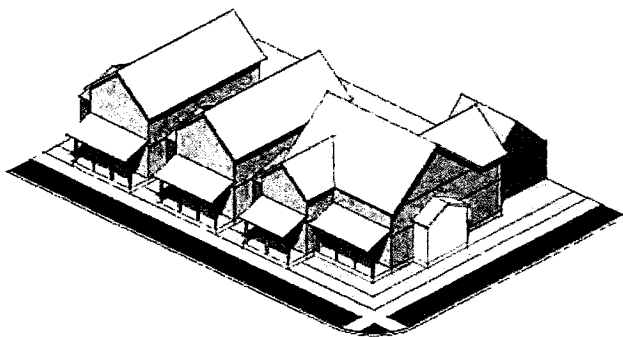

MODIFIED TOWNHOUSE

Townhouses are connected by single bay garages. These work well on shallower lots.

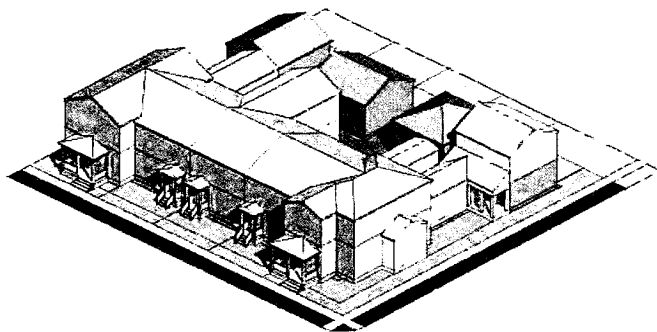

TOWNHOUSE/ROWHOUSE

This versatile building type creates a continuous street facade. They can be parked in a court, detached garages, or tuck-under parking in the rear of the house.



BUILDING TYPES

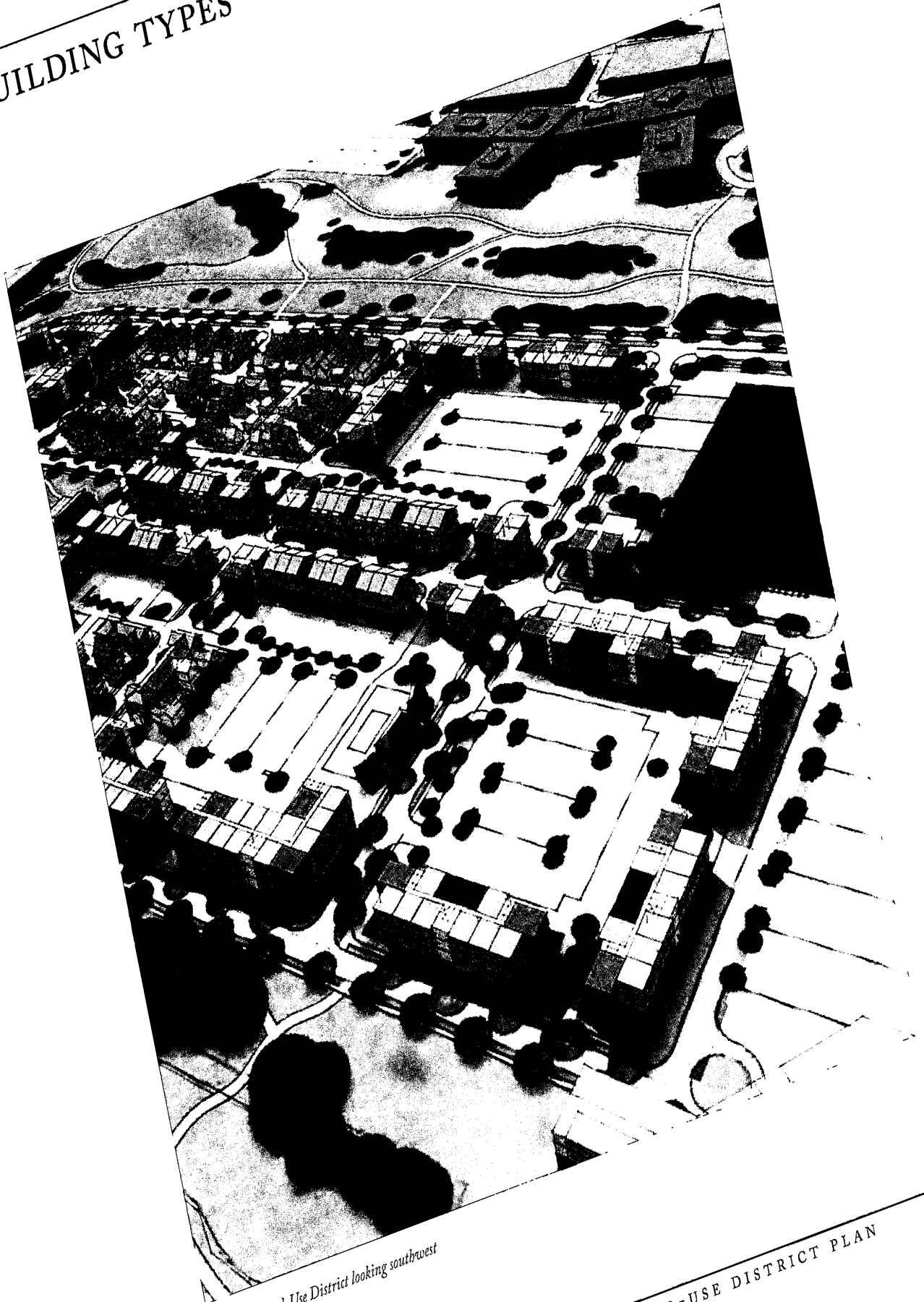

View of Mixed-Use District looking southwest

SOUTH FARM MIXED-USE DISTRICT PLAN



View of Mixed-Use District looking east



TABLE OF CONTENTS



<p>PREPARED FOR Noddle Development Company</p> <p>CONSULTANT TEAM Urban Design Associates HDR, Inc. HR&A Advisors Lamp Rynearson & Associates, Inc.</p>	<p>EXECUTIVE SUMMARY</p> <p>EXECUTIVE SUMMARY 2</p> <p>SUMMARY OF MASTER PLAN</p> <p>SUMMARY OF THE MASTER PLAN 8</p> <p>DESIGN AND DEVELOPMENT PRINCIPLES 10</p> <p>LAND USE PLAN 12</p> <p>LANDMARKS, FOCAL POINTS, AND AXES 14</p> <p>STREET TYPES 16</p> <p>OPEN SPACE SYSTEM 18</p> <p>TRAIL SYSTEM 20</p> <p>RESIDENTIAL NEIGHBORHOOD GUIDELINES</p> <p>RESIDENTIAL DISTRICTS 24</p> <p>NEIGHBORHOOD RECREATION AREAS 28</p> <p>RESIDENTIAL STREETS 30</p> <p>Multi-Family Streets 31</p> <p>Residential Streets and Alleys 32</p> <p>RESIDENTIAL FRONT YARD SETBACKS 34</p> <p>Multi-Family Housing 36</p> <p>Attached Housing 38</p> <p>Single-Family Housing 40</p>
---	---

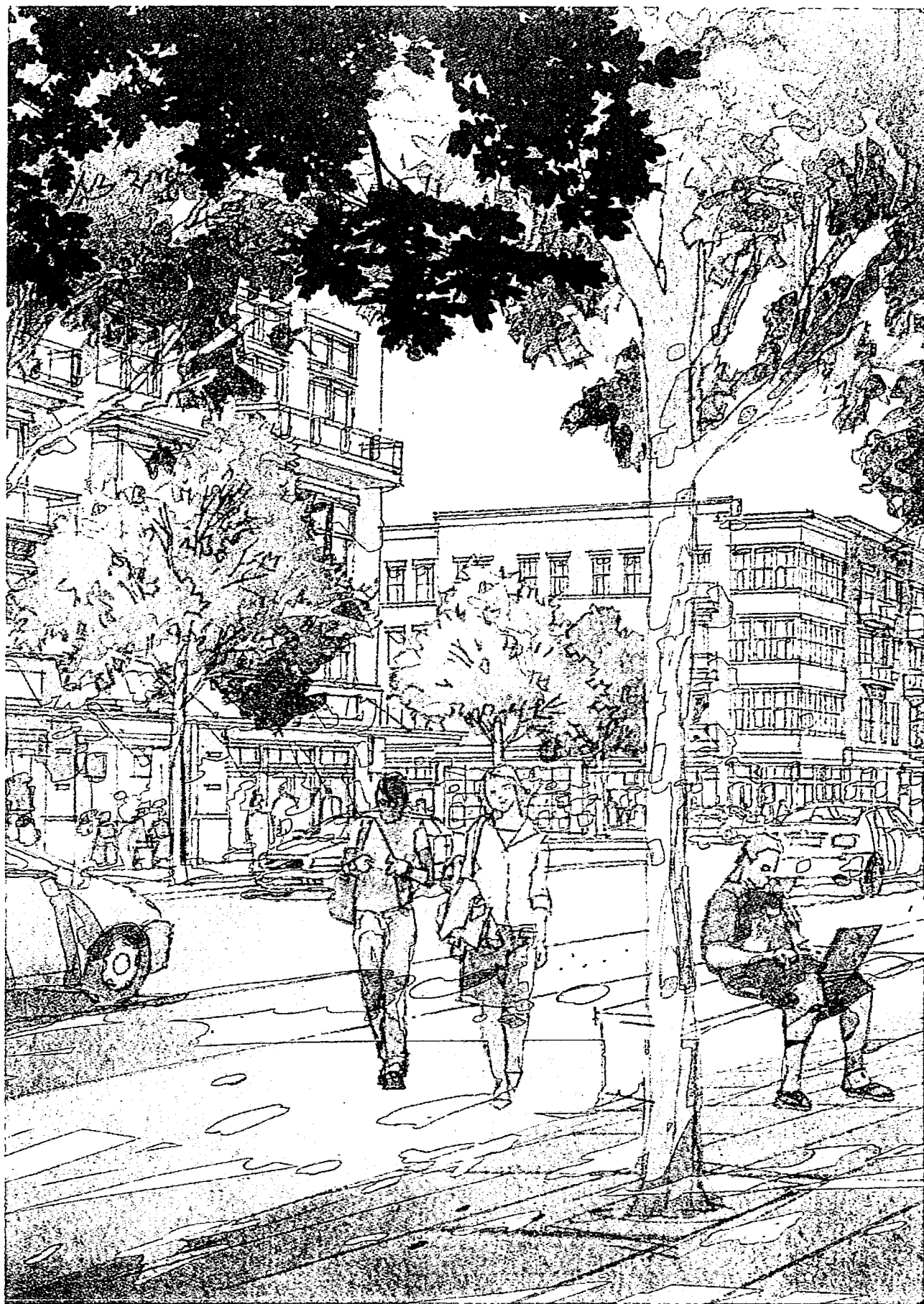

EXECUTIVE SUMMARY

EXECUTIVE SUMMARY

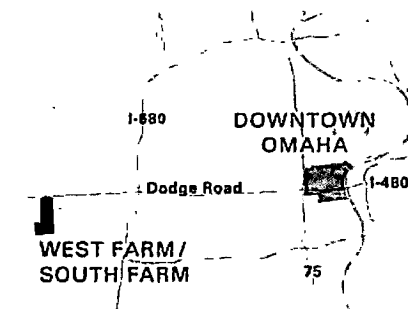

Locator Plan

The West Farm/South Farm Development is a new mixed-use community located on farmland once owned and operated by the historic Boys Town Village and the DeMarco family. This new development is strategically located in the major growth area of western Omaha between West Dodge Road and Pacific Street at the corner of 144th Street.

- » West Farm, the northern part of the development formerly owned by Boys Town, will include a mixed-use town center with shops and restaurants, a retail center, an office park, urban apartment living, and a major new central park and trail system.
- » South Farm, formerly owned by the DeMarco family, will include a new corporate campus for Applied Underwriters, a mixed-use village with neighborhood retail and residential, and an exclusive large lot residential community, all connected by an open space network of rolling hills and trails.
- » In total, the development will include over 1,400,000 square feet of office space, 819,000 square feet of retail, a 300-room hotel, 1,600 apartments, 144 townhouses, and 290 single-family houses. One-third of the total land area will be devoted to parks, trails, and recreation areas.



Boys Town Farm Village in the town center



Development and surrounding area



A mix of uses, including office, residential, and retail, activates the streets



Neighborhood parks serve as the heart of the community

EXECUTIVE SUMMARY

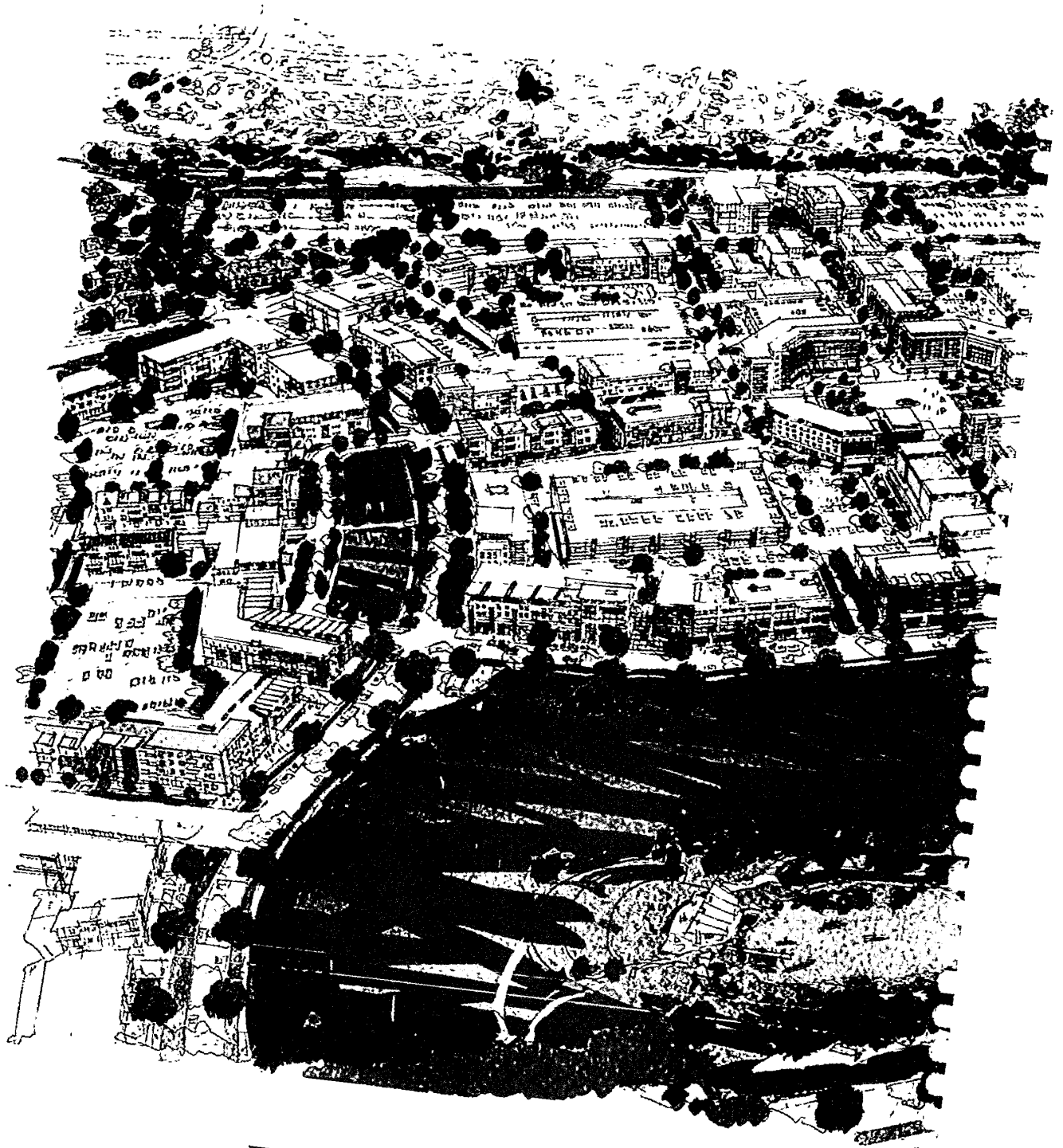





SUMMARY OF MASTER PLAN

SUMMARY OF THE MASTER PLAN

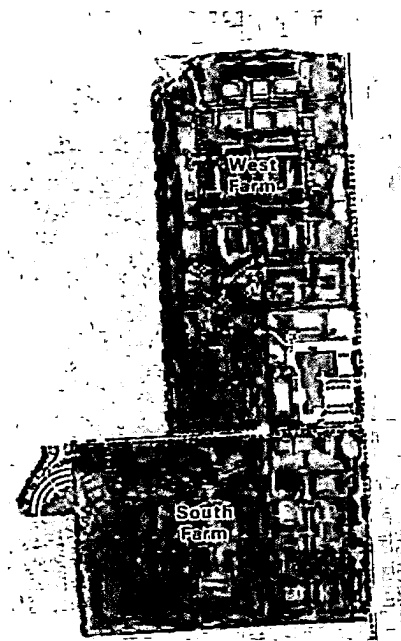

The West Farm/South Farm Development Master Plan is a dramatic new mixed-use development in western Omaha, offering a rich and diverse lifestyle for residents, office workers, and visitors. The plan integrates many aspects of life into a compact, walkable village with safe, comfortable, and interesting streets, parks, and activities.

MIXED-USE DISTRICTS

The core of the project is a pleasant shopping and dining district located in West Farm with a wide selection of restaurants and retailers. Designed for those who love urban life, upstairs apartments and office lofts will further animate the center. A shopping center for fashion and home furnishing retailers is located in the northern area near Dodge Road within easy walking distance of nearby offices and the core. South of Pacific Street is a neighborhood oriented shopping and office district with a major grocer, restaurants, and shops.

RESIDENTIAL NEIGHBORHOODS

Here, the residential neighborhoods set themselves apart by creating a walkable environment based on the finest Omaha neighborhoods from the early 20th century. The houses will be modeled after Omaha's great Tudor, Craftsman, and Colonial houses. Garages will be alley loaded so that streets can be lined with porches, authentic facades, and gardens instead of garage doors.

OPEN SPACE

Nearly one-third of the land development area is devoted to outdoor activities, trails, and recreation. Two large civic parks, a village square, family-oriented neighborhood parks, and a continuous trail looping the site, will offer a healthy lifestyle for residents and office workers.

01 MAR 2017

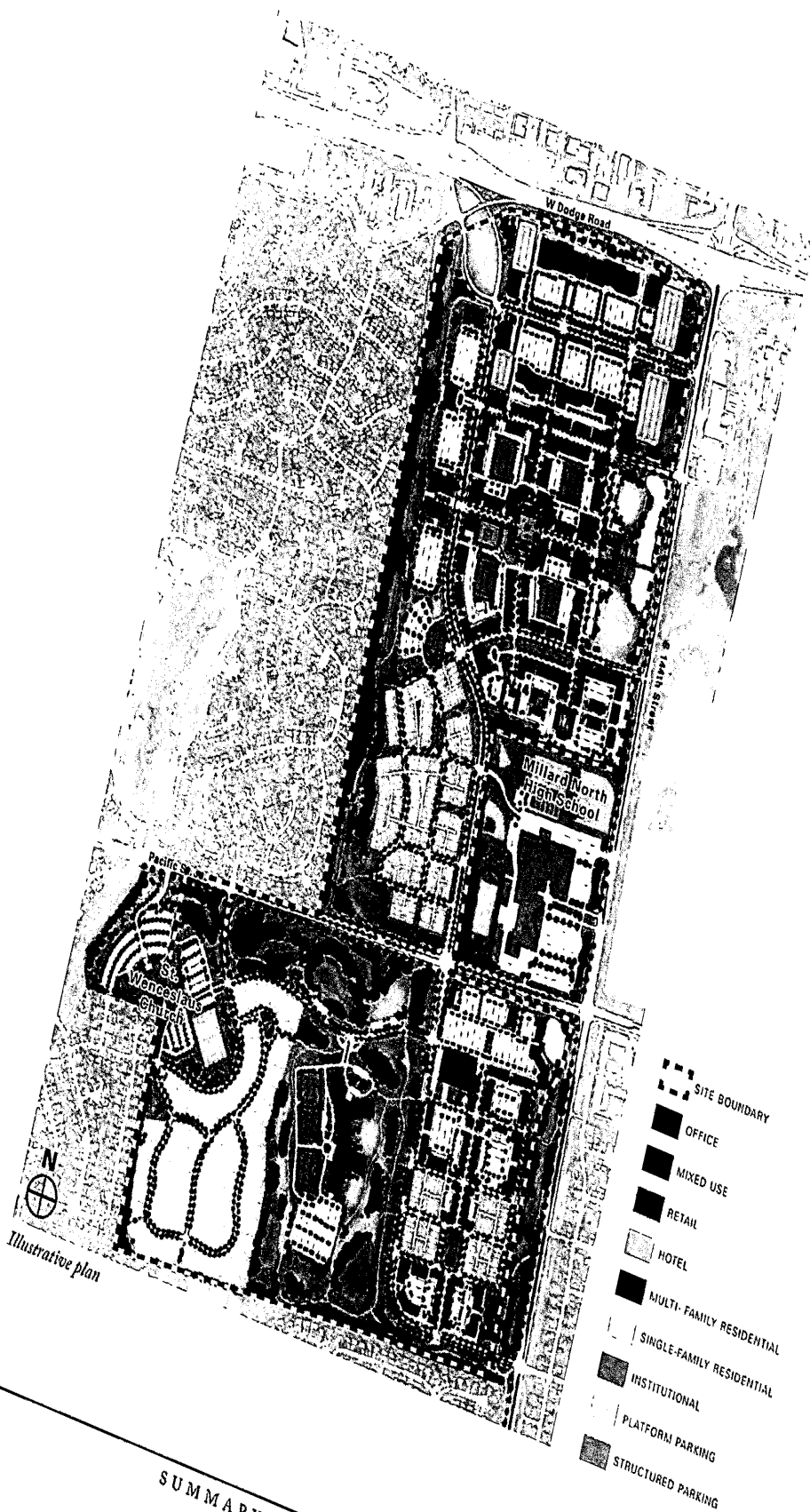

Illustrative plan

SUMMARY OF THE MASTER PLAN

DESIGN AND DEVELOPMENT PRINCIPLES

West Farm/South Farm presents a unique opportunity for enriching western Omaha with a new mixed-use walkable development consisting of several neighborhoods and districts. The following design and development principles were followed in the design process.

DESIGN AND DEVELOPMENT PRINCIPLES
<p>1. CREATE A 24/7 PEDESTRIAN-FRIENDLY ENVIRONMENT</p> <ul style="list-style-type: none"> » Build compact pedestrian friendly mixed-use neighborhoods » Locate many activities of daily living within walking distance » Build interconnected streets to encourage walking and to reduce the number and length of automobile trips, and conserve energy. » Build trails that provide pleasant walking and biking routes connecting to all neighborhoods and adjacent communities. <p>2. PROVIDE A MIX OF USES</p> <ul style="list-style-type: none"> » Office Park » Mixed-use commercial center with retail, residential, and office » Apartment neighborhoods » Single-family neighborhood » Corporate campus for Applied Underwriters » Neighborhood shopping district » Civic parks » Extensive trail network <p>3. PROVIDE A RANGE OF HOUSING CHOICES</p> <ul style="list-style-type: none"> » Urban center apartments and condominiums » Apartment communities » Mansion apartments » Townhouses » Urban single-family houses » Large houses and mansions <p>4. CREATE A UNIQUE RANGE OF PUBLIC SPACES</p> <ul style="list-style-type: none"> » Gateway park with an amphitheater and lake » Farm-to-table garden and dining district » Public square » Residential neighborhood parks » Ravines and natural areas » Trails <p>5. PROVIDE SHARED PARKING AREAS SCREENED FROM PUBLIC STREETS</p> <p>6. DESIGN URBAN BUILDINGS</p> <ul style="list-style-type: none"> » Buildings should define streets and public spaces as places of shared use » Commercial buildings should animate and enrich public streets » Houses should be designed based on Omaha's great residential neighborhoods with beautiful facades, porches, and landscaping — no garage doors facing the street

01 MAR 2017

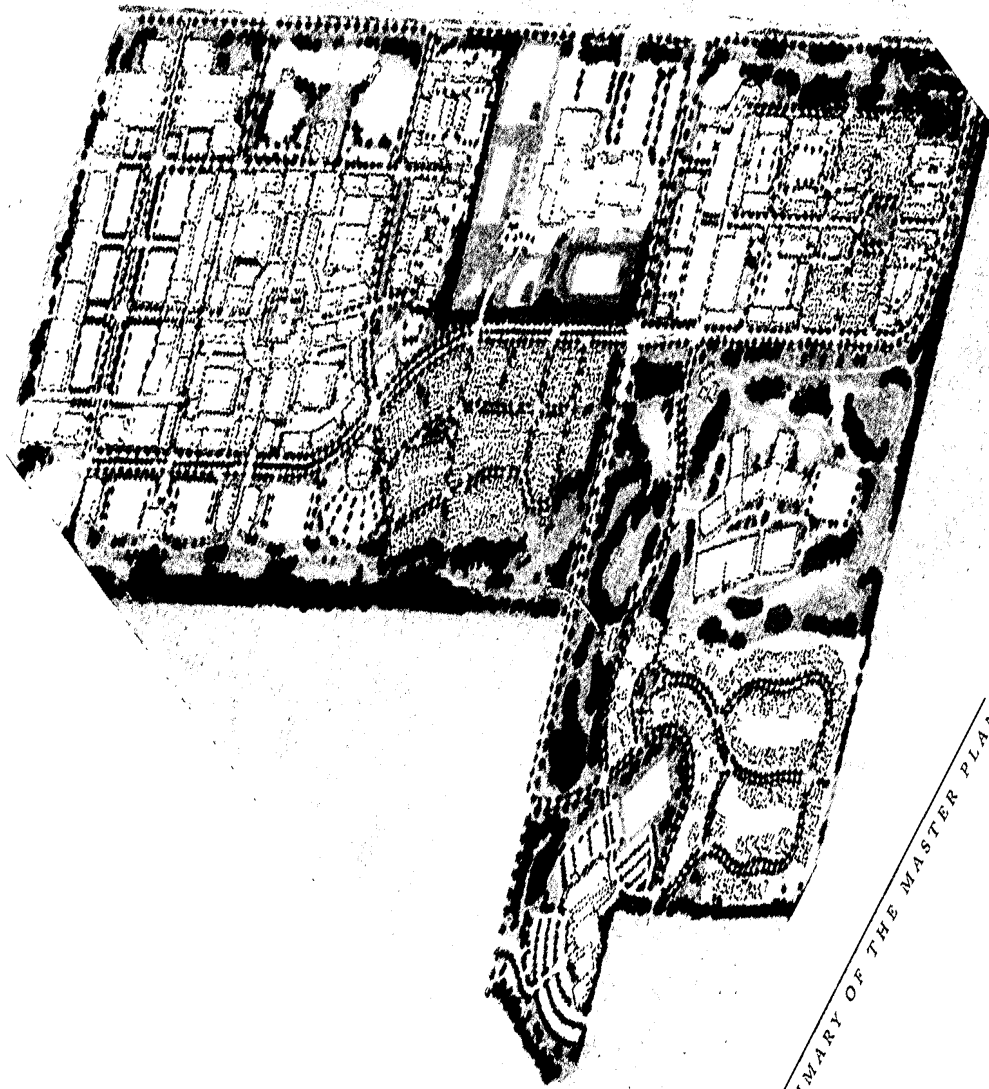

SUMMARY OF THE MASTER PLAN

LAND USE PLAN

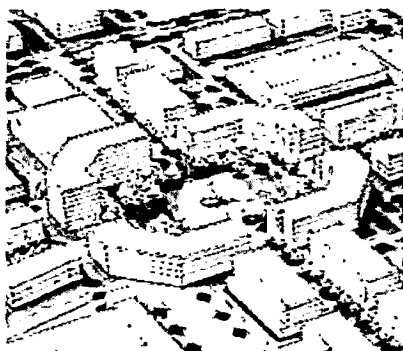

View of Mixed-Use town center

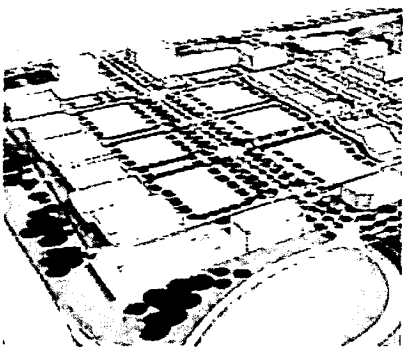

View of commercial center on West Farm

The Land Use Plan consists of two types of land use districts: Mixed-Use and Residential. Both land use categories are found in West Farm and South Farm as shown on the adjacent plan.

MIXED-USE DISTRICTS

The Mixed-Use Districts include open space, the parkway, and streets serving the districts, retail, office, multi-family residential, and institutions. Residential Districts include residential open space, streets serving residential units, multi-family and single family residential development.

Commercial uses including retail and office development are concentrated in the highly visible northern part of West Farm and at the intersection of 144th and Pacific Street in South Farm. The Applied Underwriters offices are located in a pastoral campus setting in South Farm, visible from Pacific Street but buffered from adjacent areas by substantial landscaped open space.

RESIDENTIAL DISTRICTS

Residential Districts are located in the quieter, less visible areas of the two farms adjacent to existing residential neighborhoods. The predominant land use throughout the three districts is single-family housing. However, the South Farm village located in the southeast corner includes attached houses and small multi-family buildings.



Development Summary Chart

District	Office (SF)	Retail (SF)	Hotel (Rooms)	Multi-Family (Units)	Townhouse (Units)	Single Family (Units)
West Farm						
Residential	--	--	--	--	--	162
Mixed-Use	948,100	652,910	300	1,285	25	--
South Farm						
Residential	--	--	--	186	68	128
Mixed-Use	458,800	165,980	--	135	51	--

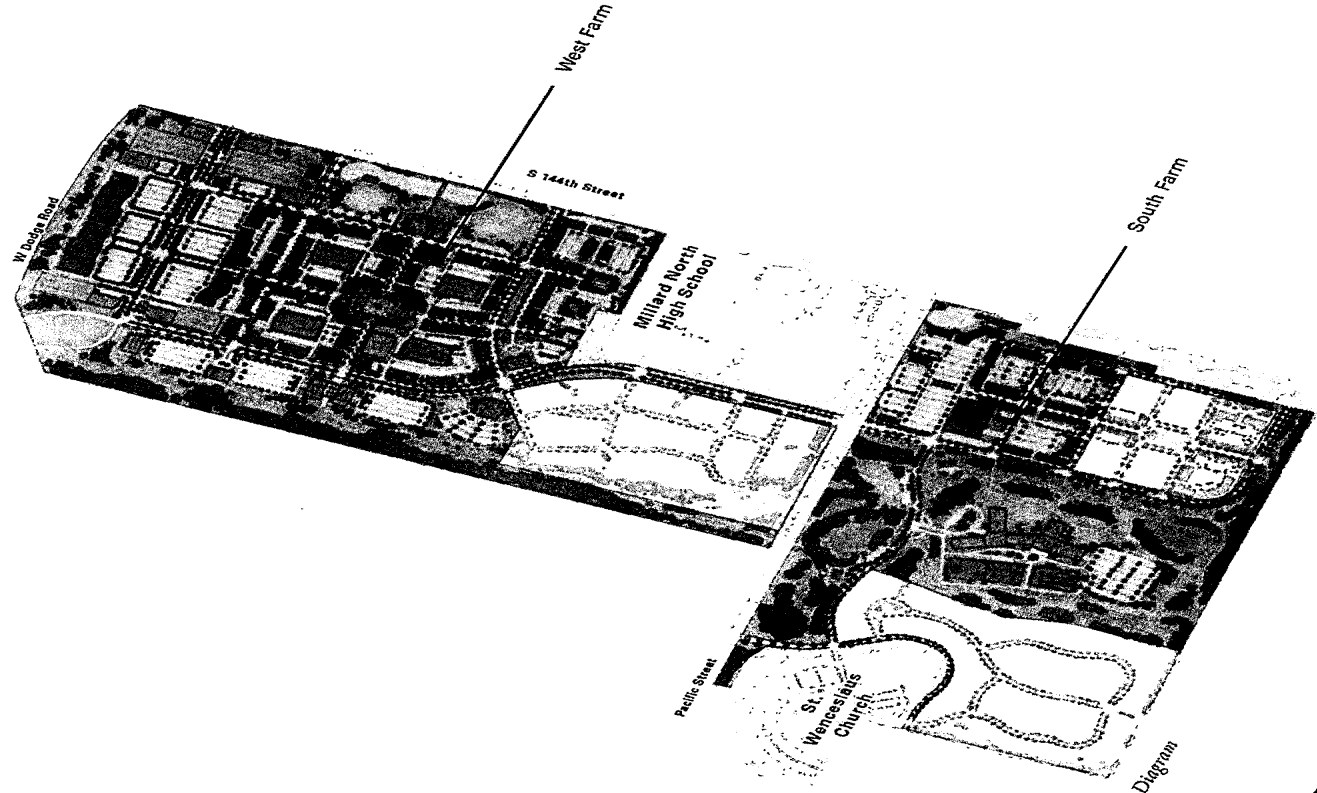
01 MAR 2017



Illustrative Plan Diagram

-  MIXED-USE DISTRICT
-  RESIDENTIAL DISTRICT

SUMMARY OF THE MASTER PLAN

LANDMARKS, FOCAL POINTS, AND AXES

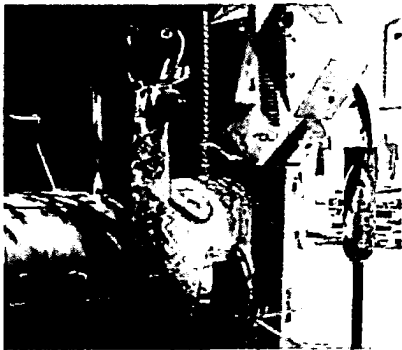

Omaha has a rich tradition of supporting local artists



Existing landmarks on site



Existing landmarks on site

The townscape of West Farm/South Farm is designed to take advantage of key view corridors and points of convergence.

GATEWAYS

Major approaches to West Farm/South Farm from Dodge Road and Pacific Street will have gateway landmarks to announce entry into the development. These may include signs, pavilions, works of art, and special landscapes. Buildings at prominent entries should be designed with corner features and interesting roofscapes to further define the entry experience.

AXIS

View corridors orient visitors to key destinations and animate their experience with visual cues. Major view corridors both north/south and east/west draw visitors to Village Square, the heart of the mixed use village center in West Farm. A north/south view corridor in the South Farm village links the residential community to the neighborhood retail center.

LANDMARKS

Landmarks include highly visible buildings, pavilions, sculptures, signage, and fountains that terminate view corridors or dominate places. One example is the proposed farm cluster at the head of the shopping street facing 144th St.



Perspective showing farm building focal points

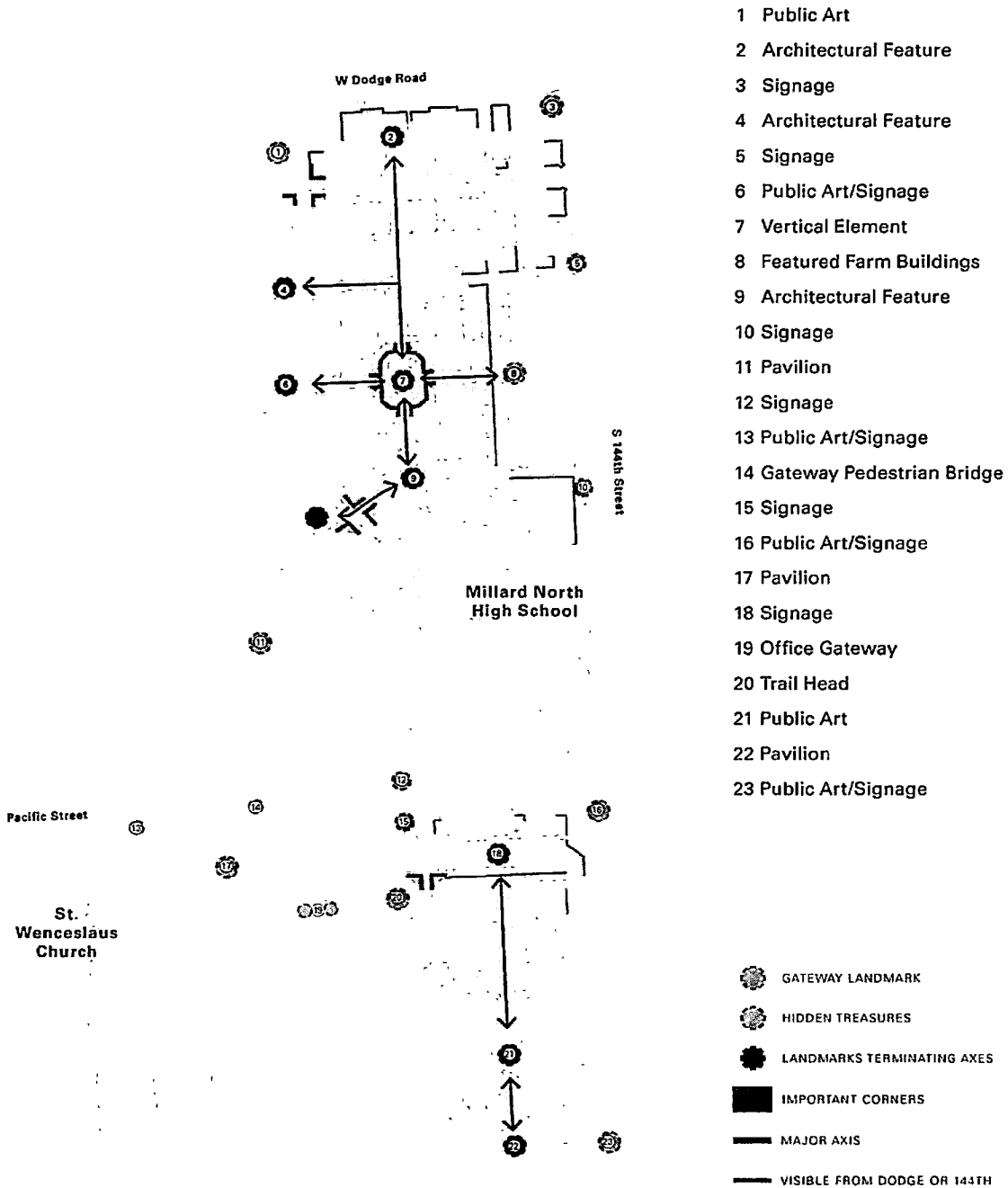

- 1 Public Art
- 2 Architectural Feature
- 3 Signage
- 4 Architectural Feature
- 5 Signage
- 6 Public Art/Signage
- 7 Vertical Element
- 8 Featured Farm Buildings
- 9 Architectural Feature
- 10 Signage
- 11 Pavilion
- 12 Signage
- 13 Public Art/Signage
- 14 Gateway Pedestrian Bridge
- 15 Signage
- 16 Public Art/Signage
- 17 Pavilion
- 18 Signage
- 19 Office Gateway
- 20 Trail Head
- 21 Public Art
- 22 Pavilion
- 23 Public Art/Signage



Landmarks, Focal Points, and Axes Diagram



STREET TYPES



Perspective of new mixed-use street



Example of Residential street



Example of a Commercial street

The street network in West Farm and South Farm is organized into a grid pattern to create walkable communities and to provide motorists with many choices to navigate the site. New streets built on the West Farm/South Farm properties will contribute to overall mobility in western Omaha by expanding the street network and creating alternative routes. Currently, a considerable amount of traffic uses Dodge Road, 144th St, and Pacific St for daily commuting and regional access. The development will add additional trips to the network but will also expand it. Improvements to existing intersections include a new interchange at 150th St and Dodge Rd as well as the widening of 144th St and Pacific St. A new north/south parkway will parallel 144th connecting the interchange at Dodge Rd and 150th St with Pacific just west of Millard North High School and will proceed further south to 144th St. New streets within the site will accommodate the traffic generated by the new development.

Street designs are influenced by the land uses they serve and are conceived as “complete streets.” These are streets designed as beautiful public spaces, with accommodation for motor vehicles, bicycles, pedestrians, street furniture, utilities, and landscaping. The development has the following street types:

- » Dodge Road
- » 144th Street
- » Pacific Street
- » The Boulevard
- » Commercial Boulevard
- » Mixed-Use Streets
- » The Village Square
- » Multi-Family District Streets
- » Residential Neighborhood Streets

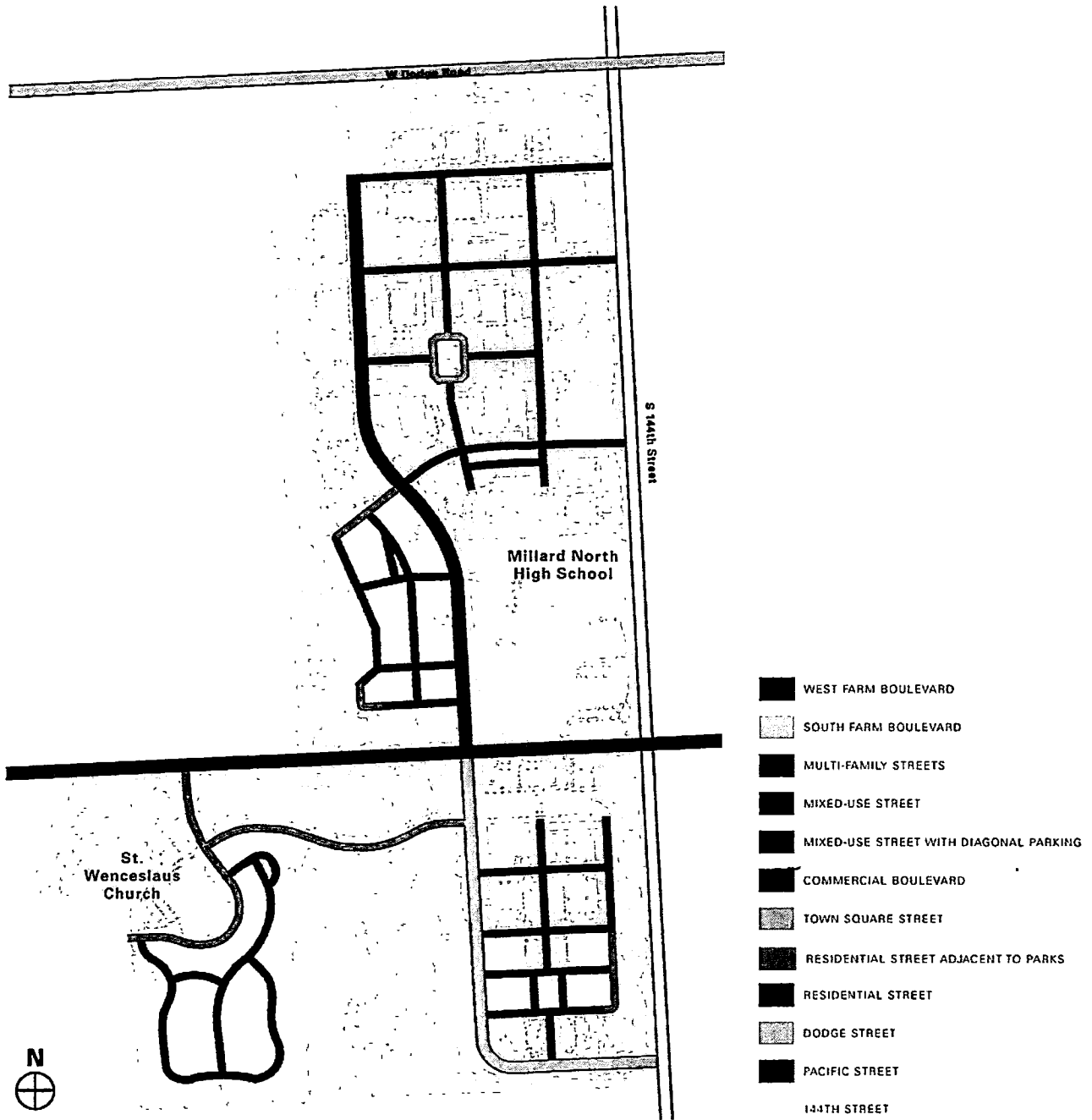

Street Type Diagram

OPEN SPACE SYSTEM



Village Square

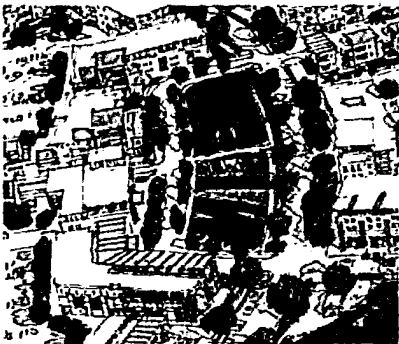

Neighborhood Recreation Area



Perspective of Central Park

West Farm/South Farm will have a rich variety of open spaces that comprise approximately one-third of the total land area of the property. The greenways, recreation areas, and urban squares will add a unique dimension to life for residents and workers in the new development. The open space character will fall into three major categories.

GREENWAYS

These spaces are remnants of the agricultural lands and forested areas that buffer the development from adjacent districts and neighborhoods. These areas are used for trails and stormwater detention and are mostly passive in character.

RECREATION

These are highly programmed open spaces designed for passive daily use and special events such as festivals and concerts. Each recreation area will have a unique role in the life of the community. The Central Area will be the most civic in nature similar to Stinson Park in Aksarben. Pacific Area will be more recreational with fewer programmed activities. The compact residential neighborhoods will have small recreation spaces with play areas designed for families and children.

PUBLIC SQUARES

Village Square will be the center of village life, designed with pavement, strategically placed shade trees, and configured to accommodate a range of festivals, markets, concerts, and seasonal events. Other smaller squares will be located for outdoor dining and to create pedestrian passages.

Open Space Summary	
Type of Open Space	Acreage
Village Square	1.15
Recreation Areas	41.1
Campus	39.2
Neighborhood Recreation	3
Greenways	111.5
Gateway	4.78
Total	200.8

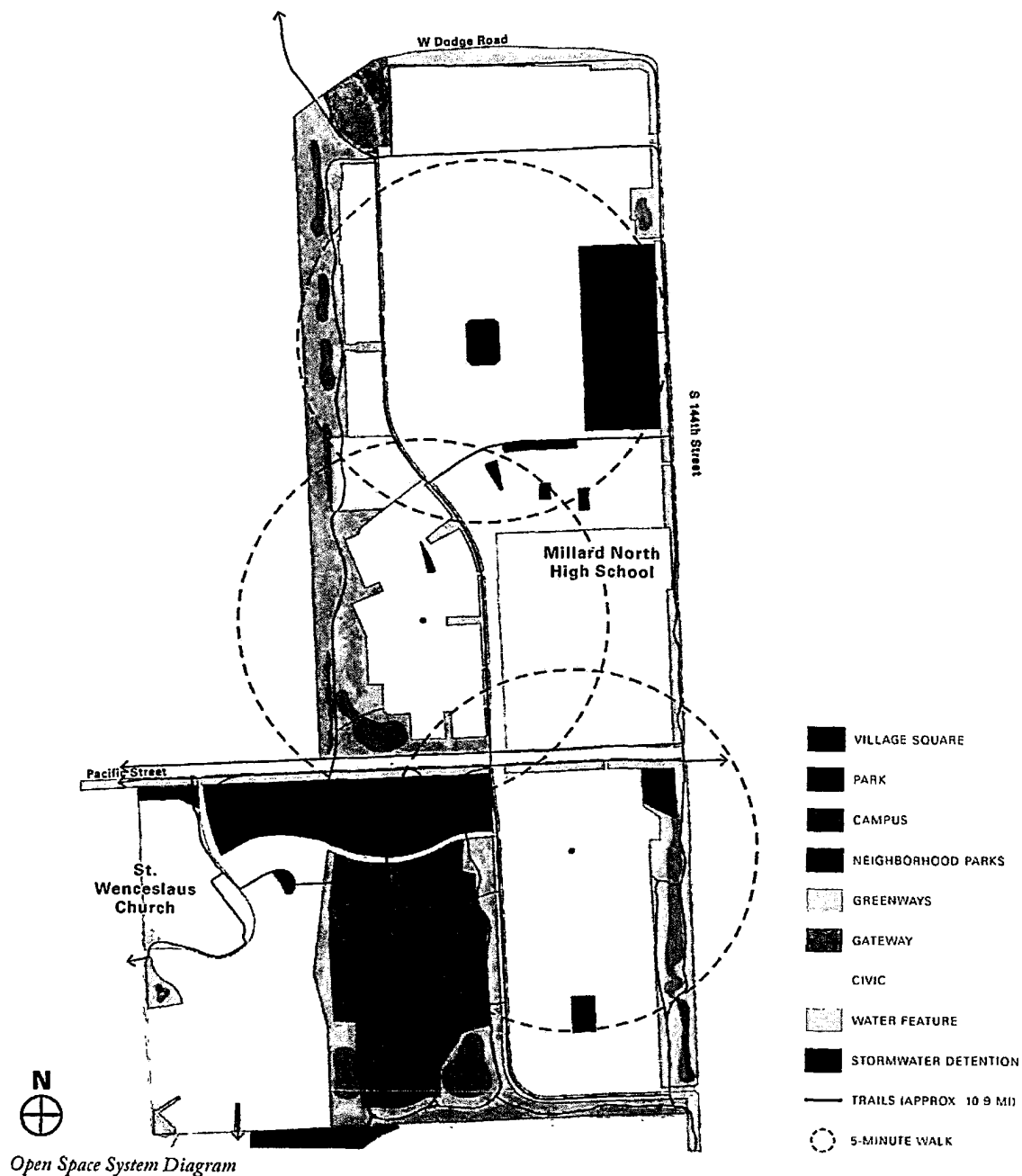

TRAIL SYSTEM

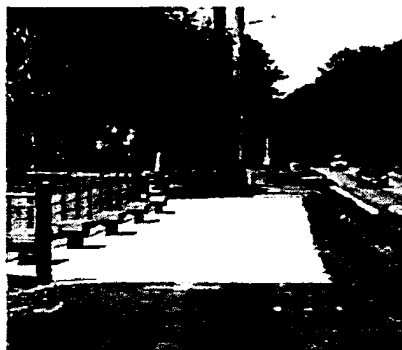

Multi-use trails will parallel streets.



Other trails will meander through natural areas.



Trails will connect residents and office workers with commercial centers

One of the most distinguishing qualities of the West Farm/South Farm plan is the extensive trail network that has been integrated into the design. The trail system will offer running, walk, and bike routes of differing lengths with an endless combination of distances. Trails are located to take advantage of the extensive open space system passing from one park and recreation area to the next. The trail network in West Farm/South Farm will connect to existing trails to the southern neighborhoods.



A trail bridge will cross Pacific Street to provide continuity between West Farm and South farm and improve public safety. The bridge will be a gateway element for the development.



Multi-use trails will be integrated into the design of streets

01 MAR 2017

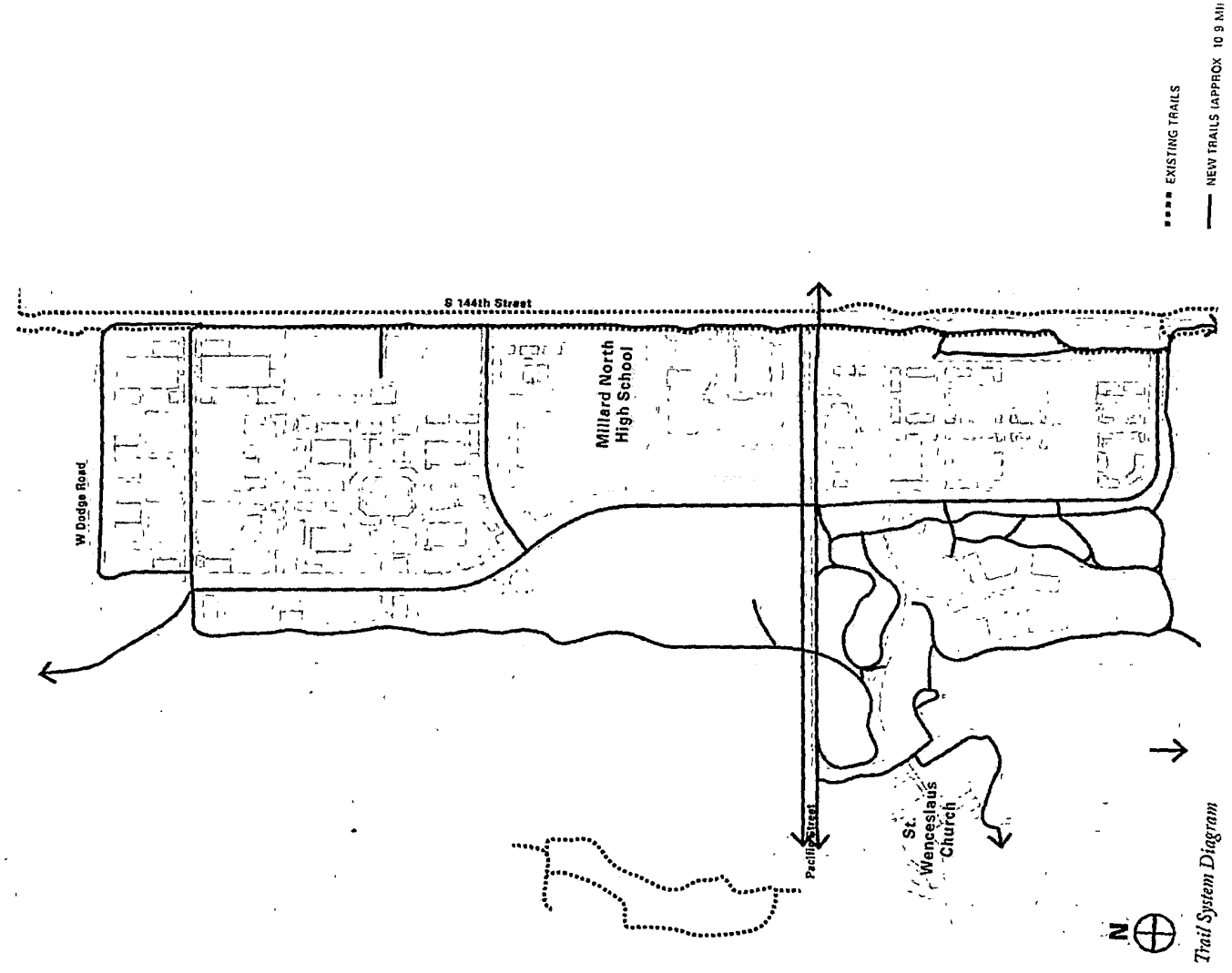

----- EXISTING TRAILS
 - - - - - NEW TRAILS (APPROX 10.9 MI)



Trail System Diagram



**RESIDENTIAL
NEIGHBORHOOD
GUIDELINES**

RESIDENTIAL DISTRICTS

West Farm/South Farm has three Residential Districts that are unique in character. These neighborhoods offer different lifestyles for residents and consequently different housing products.



Example of mansion apartment type

WEST FARM SOUTH DISTRICT

West Farm South District is a single-family residential neighborhood with smaller lot sizes for cottage and village style homes. This neighborhood is within easy walking distance of the Village Center and will be attractive to those families who desire a more urban lifestyle with the comfort of a single-family unit. West Farm South is designed with service lanes and rear access for parking pads and garages. This allows the front of the houses to be designed with porches and other elements in traditional residential vocabularies.



Example of multi-family housing

SOUTH FARM EAST DISTRICT

South Farm East District is a village with cottages, townhouses and small apartment buildings, a neighborhood square, and nearby trails, all within easy walking distance of shopping. This district has the feel of a compact, intimate village. Similar to West Farm South, the blocks have service alleys for rear lot parking freeing up the fronts of the houses to have generous porches and unique design features.

SOUTH FARM WEST DISTRICT

This neighborhood is different from the other two because it is arranged for large lot estate homes with gracious curving streets and deep setbacks. The lots average ½ acre in size to fit large homes, pools, dependencies and yards. Like the other two districts, residents have immediate access to an extensive recreational trail system.



Example of single-family development

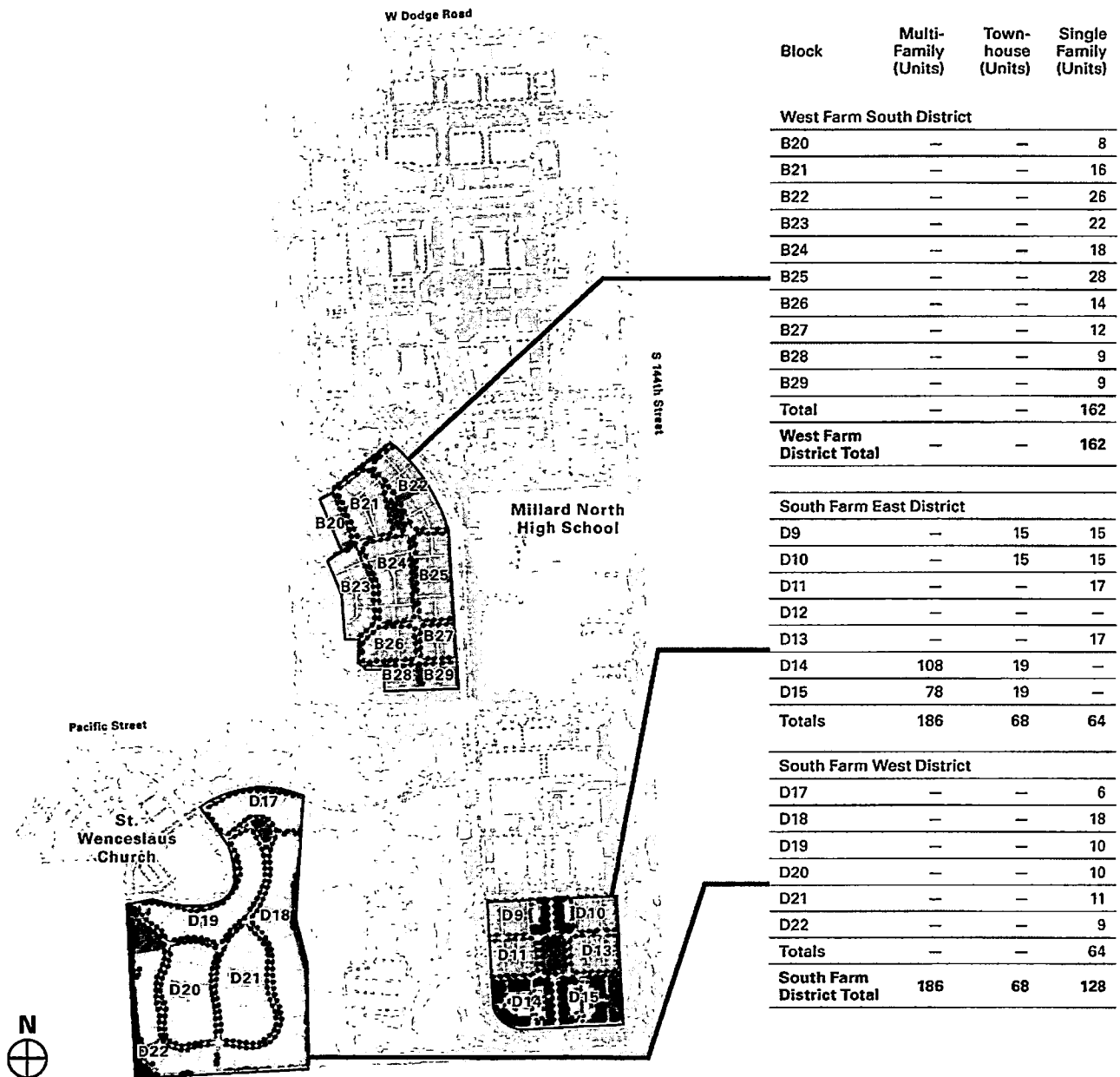

Block	Multi-Family (Units)	Town-house (Units)	Single Family (Units)
West Farm South District			
B20	--	--	8
B21	--	--	16
B22	--	--	26
B23	--	--	22
B24	--	--	18
B25	--	--	28
B26	--	--	14
B27	--	--	12
B28	--	--	9
B29	--	--	9
Total	--	--	162
West Farm District Total	--	--	162
South Farm East District			
D9	--	15	15
D10	--	15	15
D11	--	--	17
D12	--	--	--
D13	--	--	17
D14	108	19	--
D15	78	19	--
Totals	186	68	64
South Farm West District			
D17	--	--	6
D18	--	--	18
D19	--	--	10
D20	--	--	10
D21	--	--	11
D22	--	--	9
Totals	--	--	64
South Farm District Total	186	68	128

Residential Block Diagram

RESIDENTIAL DISTRICTS

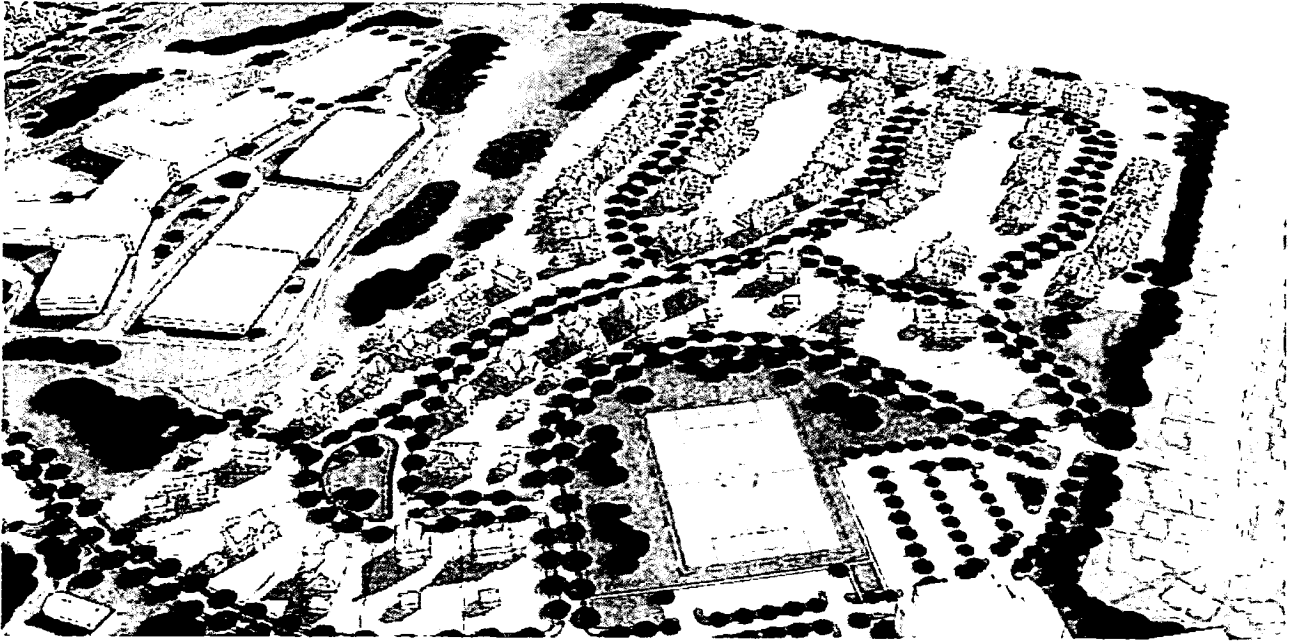

South Farm West District



View of South Farm East District

01 MAR 2017

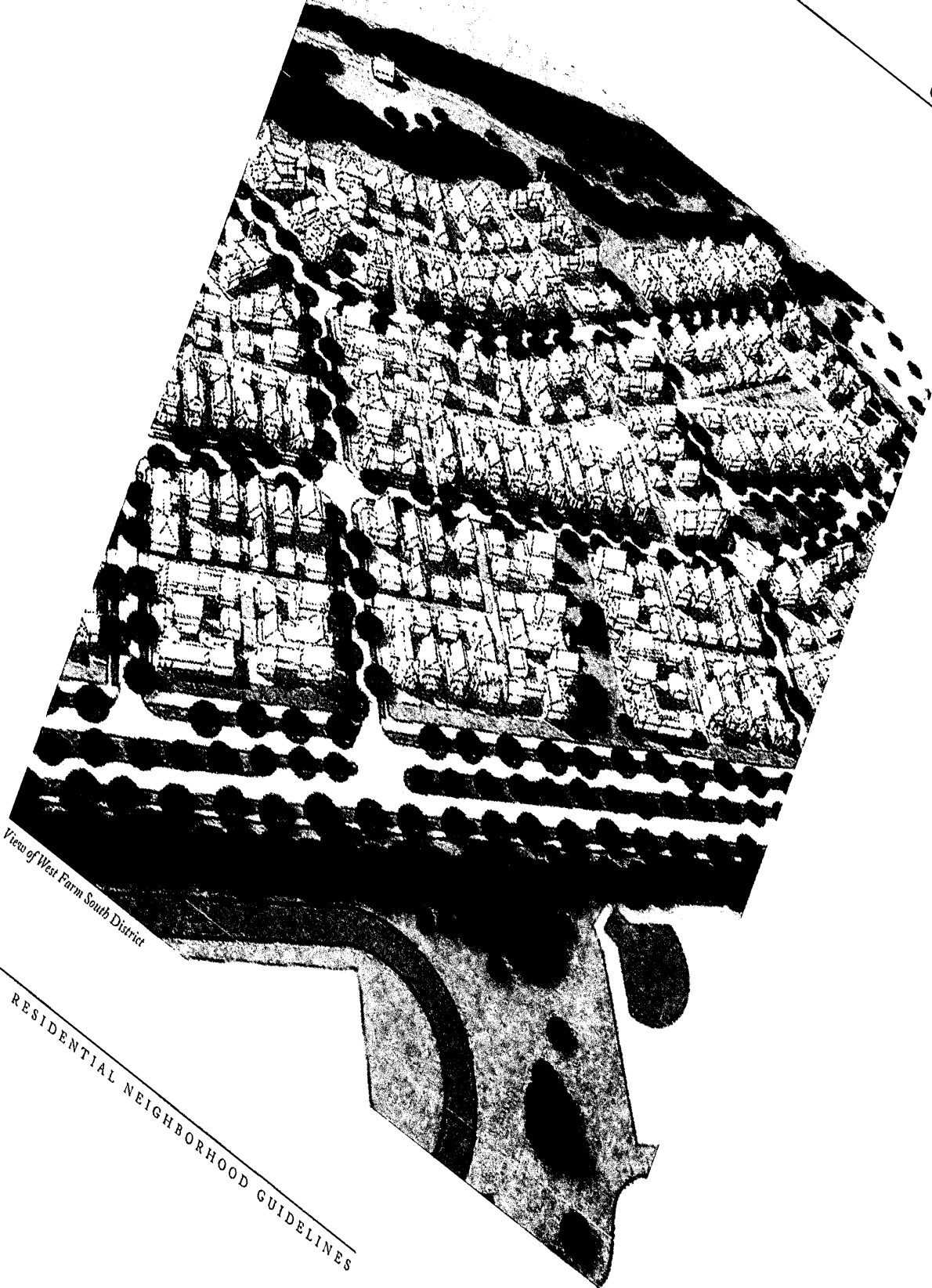

View of West Farm South District

RESIDENTIAL NEIGHBORHOOD GUIDELINES

NEIGHBORHOOD RECREATION AREAS



Neighborhood Recreation Space

Three different open spaces are designed into the residential districts;

NEIGHBORHOOD SQUARES

This recreation area features a pavilion for community events, a tot lot for young families, and an open lawn for informal field activities. It is a living room for the neighborhood.

RESIDENTIAL COURTS

Houses with front porches are grouped along a common yard that connects one street to another as would a street but without the street. The landscaped lawn court is a unique shared address that adds value for the houses that are grouped around it.

TRAIL PASSAGES

At points in each district, passages between houses are located to provide short cuts and direct access from one place to another. These passages are extensions of the larger trail system.



Neighborhood Gathering Spaces



Perspective of Neighborhood Square

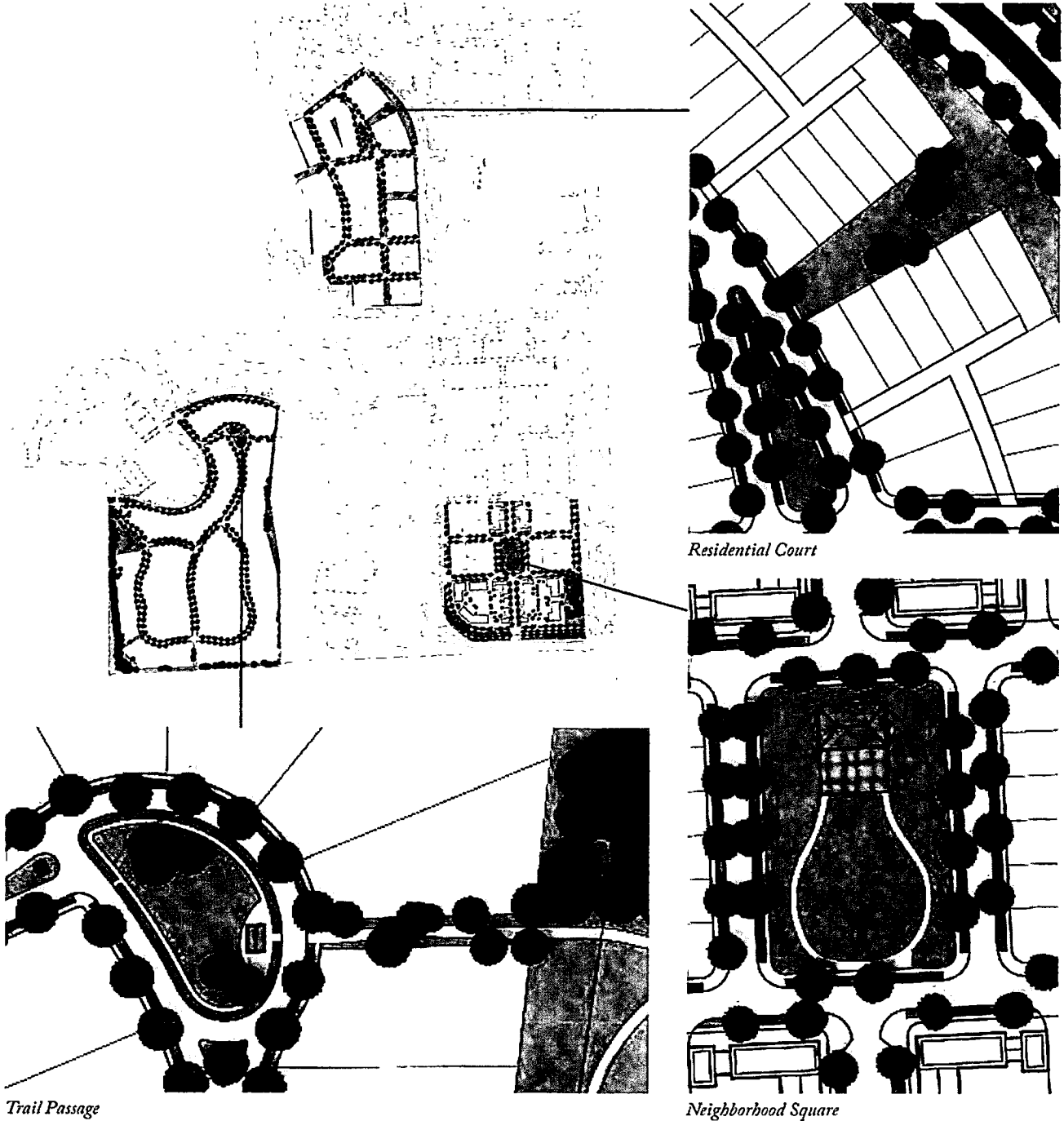

Residential Court

Trail Passage

Neighborhood Square

RESIDENTIAL STREETS

The street network in residential districts is organized into a grid of streets creating small blocks that are attractive to pedestrians and easy to navigate for motorists. Streets are designed to discourage cut-through traffic and speeding and conform to Omaha's street design standards for residential neighborhoods. Two basic types of streets are illustrated in this section.

MULTI-FAMILY STREETS

In multi-family areas where there is increased residential density, 43-foot-wide streets are designed with designated on-street parking spaces and two travel lanes.

RESIDENTIAL STREETS

In single-family areas, the standard 25 feet wide Omaha residential street is used. This informal "yield" street provides enough space for on-street parking and two-way traffic.

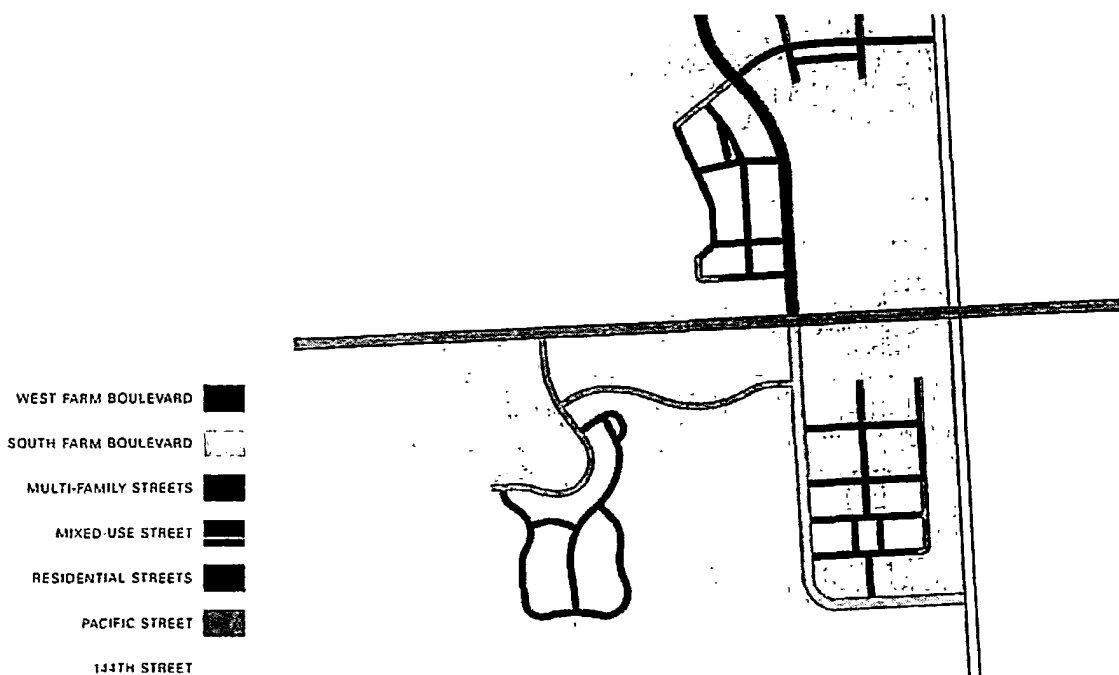



Multi-Family Streets

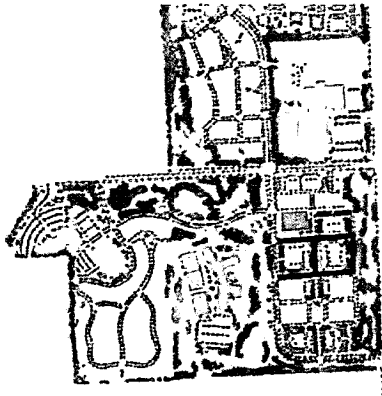

Apartment Districts in West Farm/South Farm will need easy access for a higher concentration of activity that would be found in single-family neighborhoods. Apartment streets are similar in design to Commercial streets but with more landscaping and less sidewalk area. On-street parking is provided for visitors and ground floor retail uses that may be found in apartment developments. Buildings are set back 10 feet from the street right of way line to create space for front yard landscaping to separate residential units from sidewalks. Trees are planted in continuous landscaped verges. Trees are planted in continuous landscaped verges.

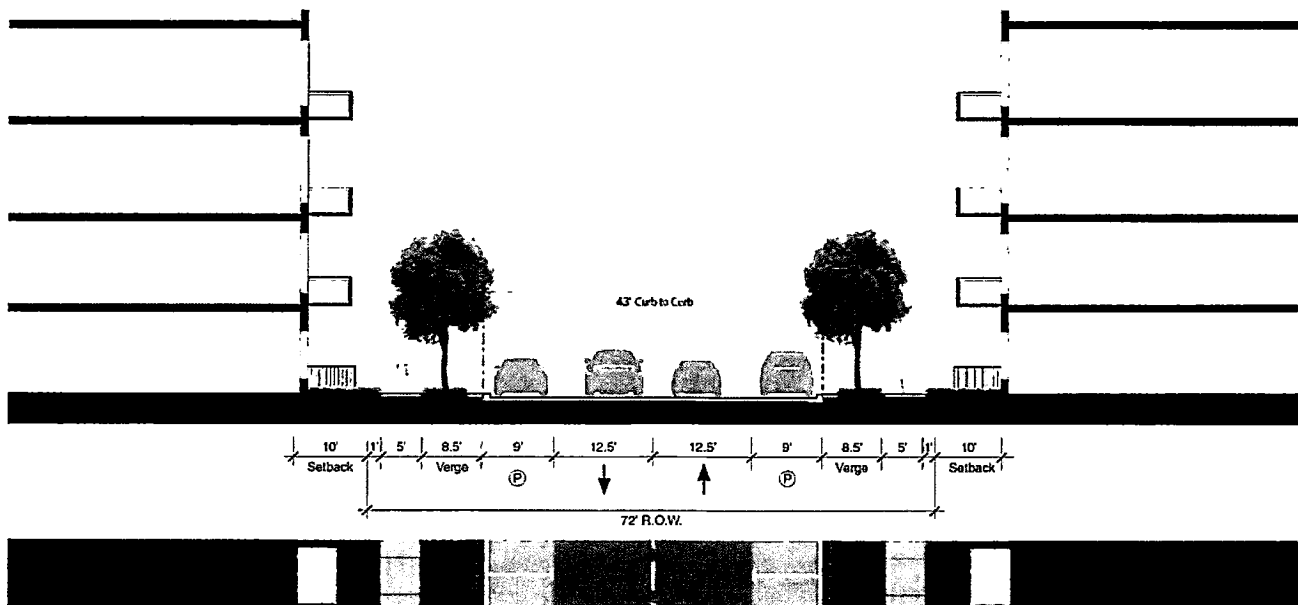

Section for Apartment Streets

RESIDENTIAL STREETS

Residential Streets and Alleys

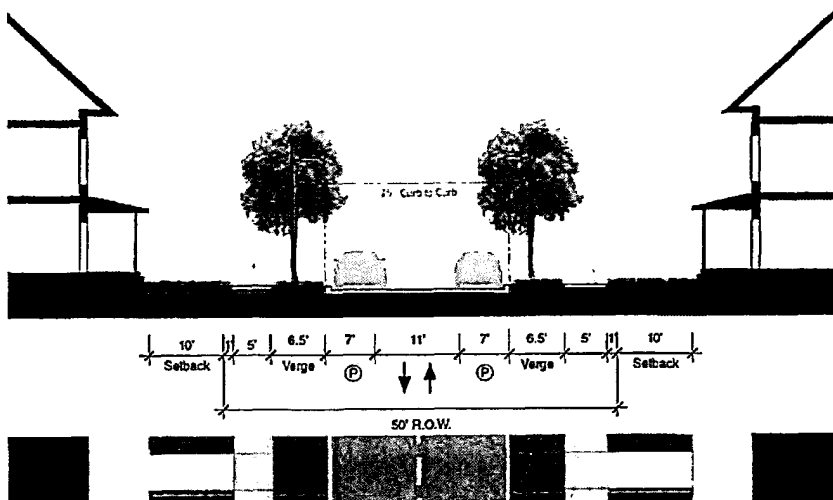
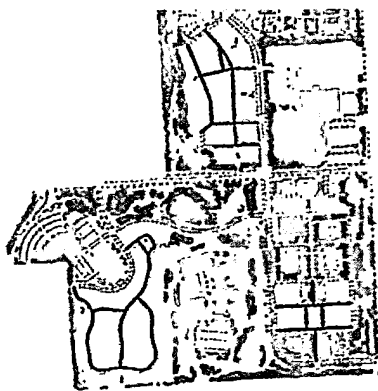

Section for Typical Residential Streets

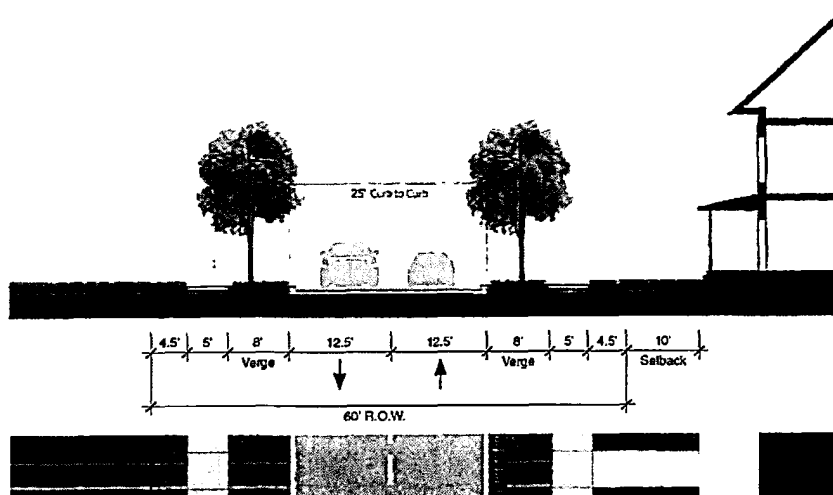
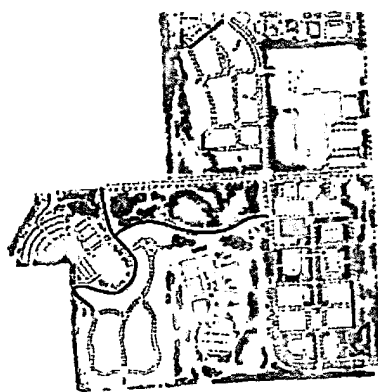

Section for Residential Streets adjacent to open space



Example of Residential Street

RESIDENTIAL STREETS

Streets in residential districts are designed to Omaha's residential street standards. These streets allow on-street parking on both sides and two-way traffic but are designed to a 25-foot width. This requires that cars sometimes must yield to on-coming traffic if cars are parked in the vicinity. This type of street is popular across the United States because it discourages speeding and provides enough space for vehicles of all sizes. The streets are designed with tree lawns and sidewalks. Two sections are shown, a typical internal street with homes on both sides, and a residential street along a recreation area with homes on one side.



Example of Residential Alley

RESIDENTIAL ALLEYS

West Farm/South and South Farm/East are designed with service alleys that provide access to lots for garages and parking areas. Service alleys also provide space for utilities including electricity, cable, gas, and water taking pressure off of the street for routing these services. Each lot will have utility service entries, parking, and space for garbage containers.



Example of Residential Alley

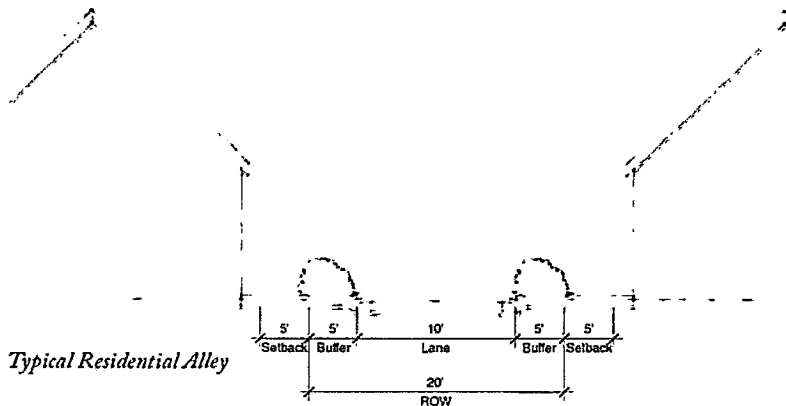

Typical Residential Alley

RESIDENTIAL FRONT YARD SETBACKS



Examples of Residential Setback

The three residential districts have different front yard setbacks for buildings. The two village districts have shallow front yards characteristic of urban neighborhoods. For houses, the setback is dimensioned to the front of the porch or the closest portion of the house facade. For apartment buildings, the setback is to the main building mass. In both single-family attached and detached buildings and apartment buildings, the setback provides a front yard for landscaping and grade transitions. The first floor of residential buildings should always be set a couple of feet above sidewalk level to create additional privacy. The South Farm West district has deep front setbacks for larger lawn and garden areas. Estate lot and mansion setbacks are a minimum of 20 feet.







Examples of Residential Setback

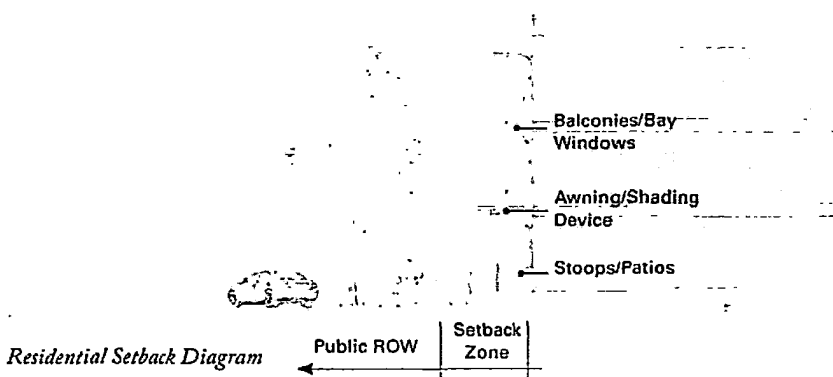

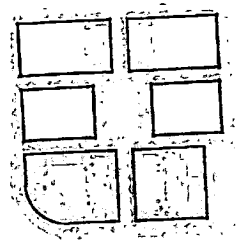
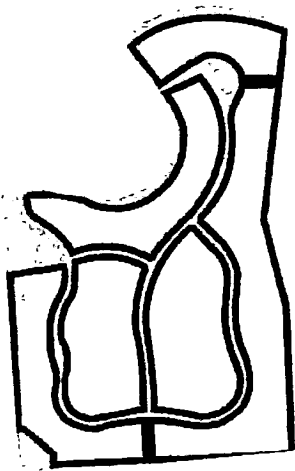
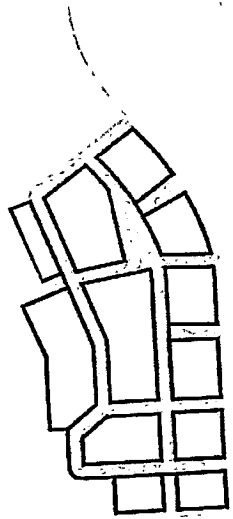
Example of Residential Alley





-  20' SETBACK
-  15 SETBACK
-  10' SETBACK

Setback Diagram

RESIDENTIAL BUILDING TYPES

Multi-Family Housing

Multi-family Housing includes the following building types:

APARTMENT BUILDINGS

Conventional apartment units with corridor access and surface parking mid-block

SOFT LOFT BUILDINGS

Urban loft units with taller floor to floor heights and loft finishes

MAISONETTE BUILDINGS

Multi-unit building with ground floor units accessed from the street with surface and/or tuck under parking

MANSION APARTMENT BUILDINGS

Small apartment buildings that appear like large houses

The ground floor of the multi-family housing facing the street must be residential units or amenities. Parking is not permitted within 20 feet of the street at the ground floor. Rear "tuck-under" parking is permitted. "Podium buildings" with parking filling the whole ground floor and apartments above must comply with design guidelines.

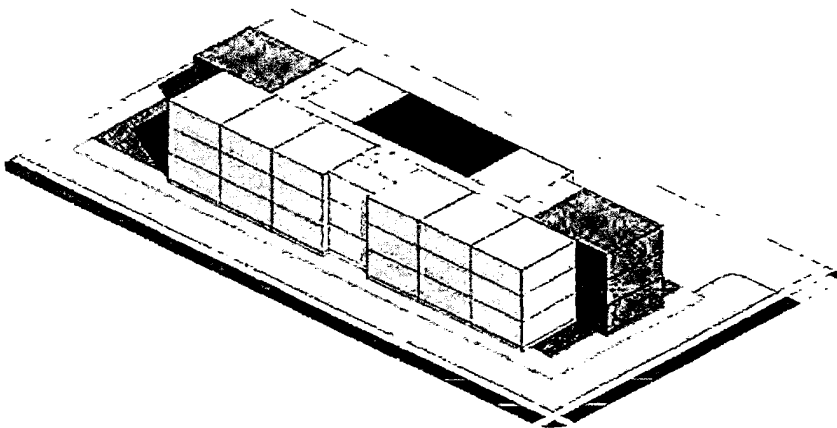

TYPICAL APARTMENT BUILDING *May range from 3–5 stories with 10-foot floor-to-floor heights.*

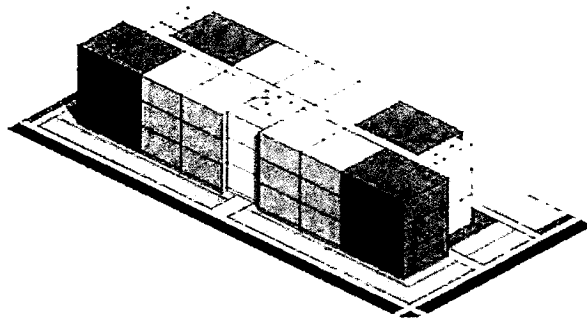

SOFT LOFT BUILDING *Taller floor to floor heights allow for loft units with mezzanines. These buildings may range from 2–8 stories.*

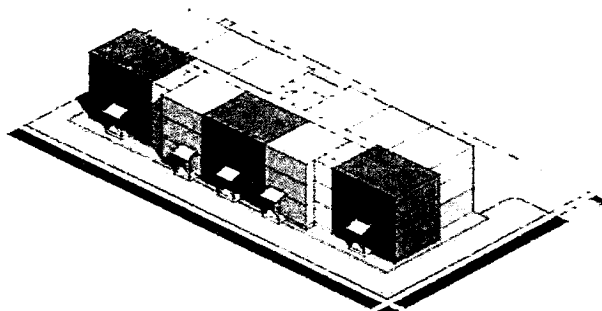
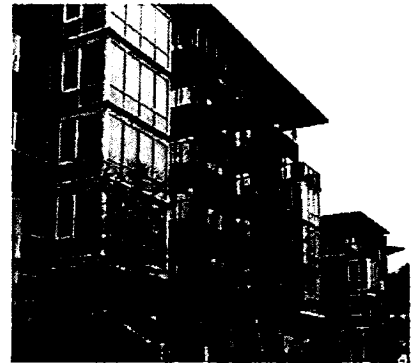

MAISONETTE BUILDING *Ground floor units are access from stoops on the street. Tuck-under parking is encouraged in the rear of the ground floor.*

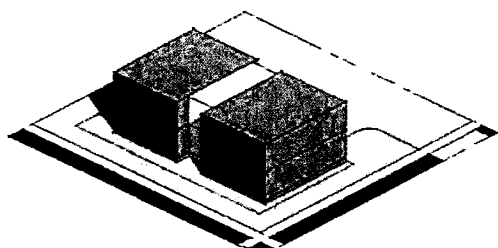

MANSION APARTMENT BUILDING *4–6 units are accessed from a shared central stair. These range from 2–3 stories.*



RESIDENTIAL BUILDING TYPES

Attached Housing

Attached houses are two or more single-family houses that share a common wall. Three forms of attached housing are included in the master plan.

CORNER DUPLEX

Two townhouses are attached and located on a corner to resemble a large house with a main body and attached wing. Each unit has a separate entrance and porch. These are attractive on corners because each street has a facing house at the intersection.

MODIFIED TOWNHOUSES

These buildings consist of individual houses attached with single story garage structures. They look like separate houses from the street even though they are joined. These units are great for shallow lots where there is not enough backyard space for parking and outdoor activities.

TOWNHOUSES

These are single-family houses of two or three stories in height that share common walls. They come in many different widths and plan configurations.

TOWNHOUSE/ROWHOUSE This versatile building type creates a continuous street facade. They can be parked in a court, detached garages, or tuck-under parking in the rear of the house.

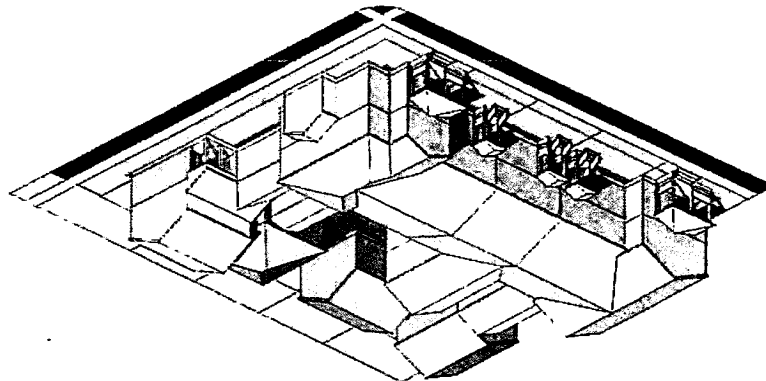

MODIFIED TOWNHOUSE Townhouses are connected by single bay garages. These work well on shallower lots.

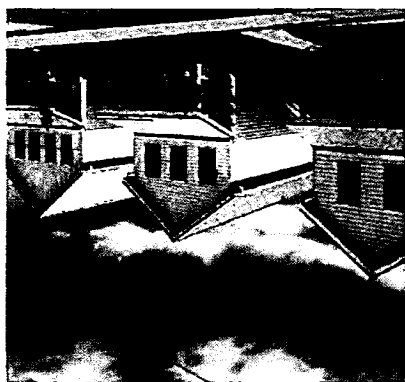
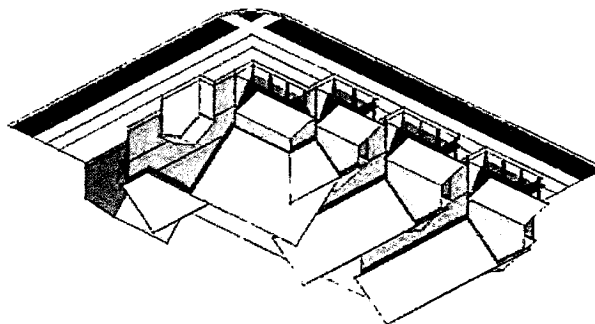

CORNER DUPLEX Articulated as a large house with two fronts, making it ideal for corner lots

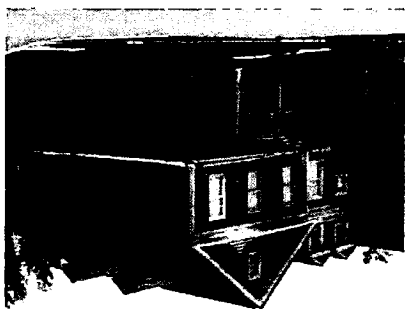
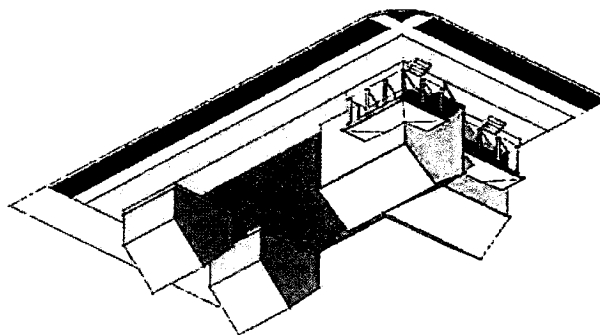

RESIDENTIAL BUILDING TYPES

Single-Family Housing

Single-family houses in West Farm/South Farm will be built on a variety of lot sizes, offering a range of price points and living styles. Houses range in size from narrow lots to mansions. House designs will be based on traditional residential vocabularies found in Omaha's best neighborhoods. The house massing, front facade, and the front yard is most important for creating attractive and beautiful streets. The first floor of houses facing the street should be living space with porches, welcoming entrances, and appropriate landscaping. The back of the house is the appropriate place for private outdoor living spaces and parking. Parking for houses in the development — with the exception of mansion lots — will be from rear lanes. This is a unique departure from typical housing developments in Omaha and will become a new model based on historic traditions for neighborhood design.

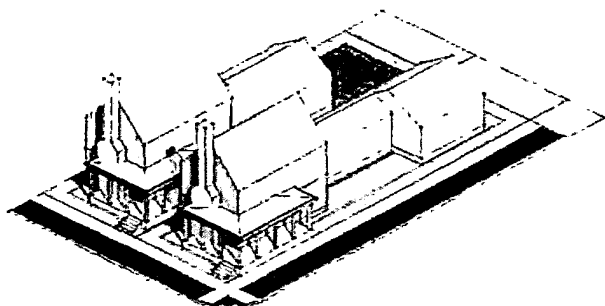

SIDE ENTRY LOT
Typical Lot Width: 30'–35'
Typical Front Setback: 10'
Height (Stories): 2

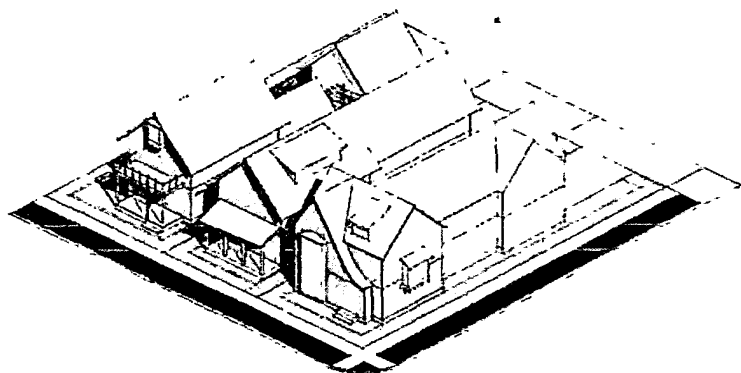

COTTAGE LOT
Typical Lot Width: 35'–45'
Typical Front Setback: 10'
Height (Stories): 1.5–2

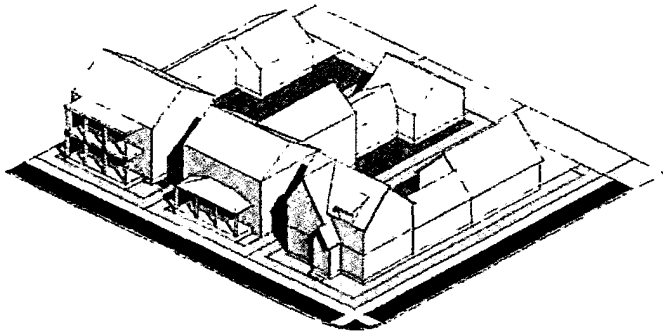

NEIGHBORHOOD LOT
Typical Lot Width: 45'-55'
Typical Front Setback: 10'
Height (Stories): 1.5-2

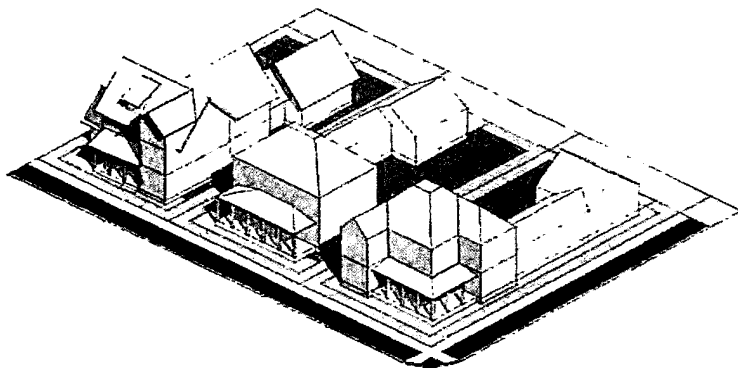

VILLAGE LOT
Typical Lot Width: 55'-65'
Typical Front Setback: 15'
Height (Stories): 2

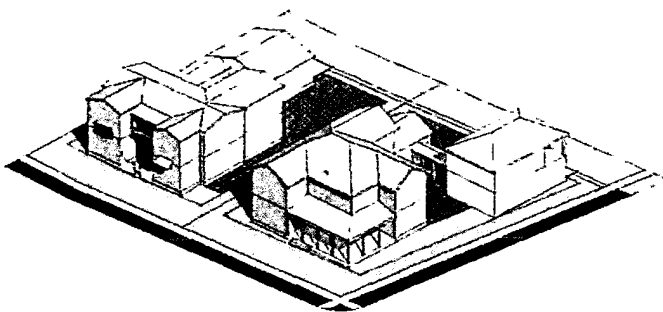

ESTATE LOT
Typical Lot Width: 65'+
Typical Front Setback: 20'-40'
Height (Stories): 2



01 MAR 2017

EXHIBIT B2



OMAHA, NEBRASKA | 01 MARCH 2017

West Farm Mixed-Use District Plan

Prepared for **N NODDLE™**
COMPANIES

Prepared by URBAN DESIGN ASSOCIATES

TABLE OF CONTENTS



PREPARED FOR
Noddle Development Company

CONSULTANT TEAM
Urban Design Associates
HDR, Inc.

HR&A Advisors
Lamp Rynearson & Associates, Inc.

WEST FARM/SOUTH FARM MASTER PLAN SUMMARY

WEST FARM/SOUTH FARM MASTER PLAN 2

WEST FARM MASTER PLAN

WEST FARM MASTER PLAN 8

WEST FARM MIXED-USE DEVELOPMENT PLAN

LAND USE PLAN 12

MASSING DIAGRAMS 14

LANDMARKS, FOCAL POINTS, AND AXES 16

OPEN SPACE SYSTEM 18

OPEN SPACES IN WEST FARM 20

TRAIL SYSTEM 22

STREET TYPES 26

MIXED-USE DISTRICT STREETS 28

BUILDING SETBACKS 34

ACCESS AND SERVICE 36

PARKING 38

BUILDING TYPES 40

BUILDING TYPES IN PLAN 46

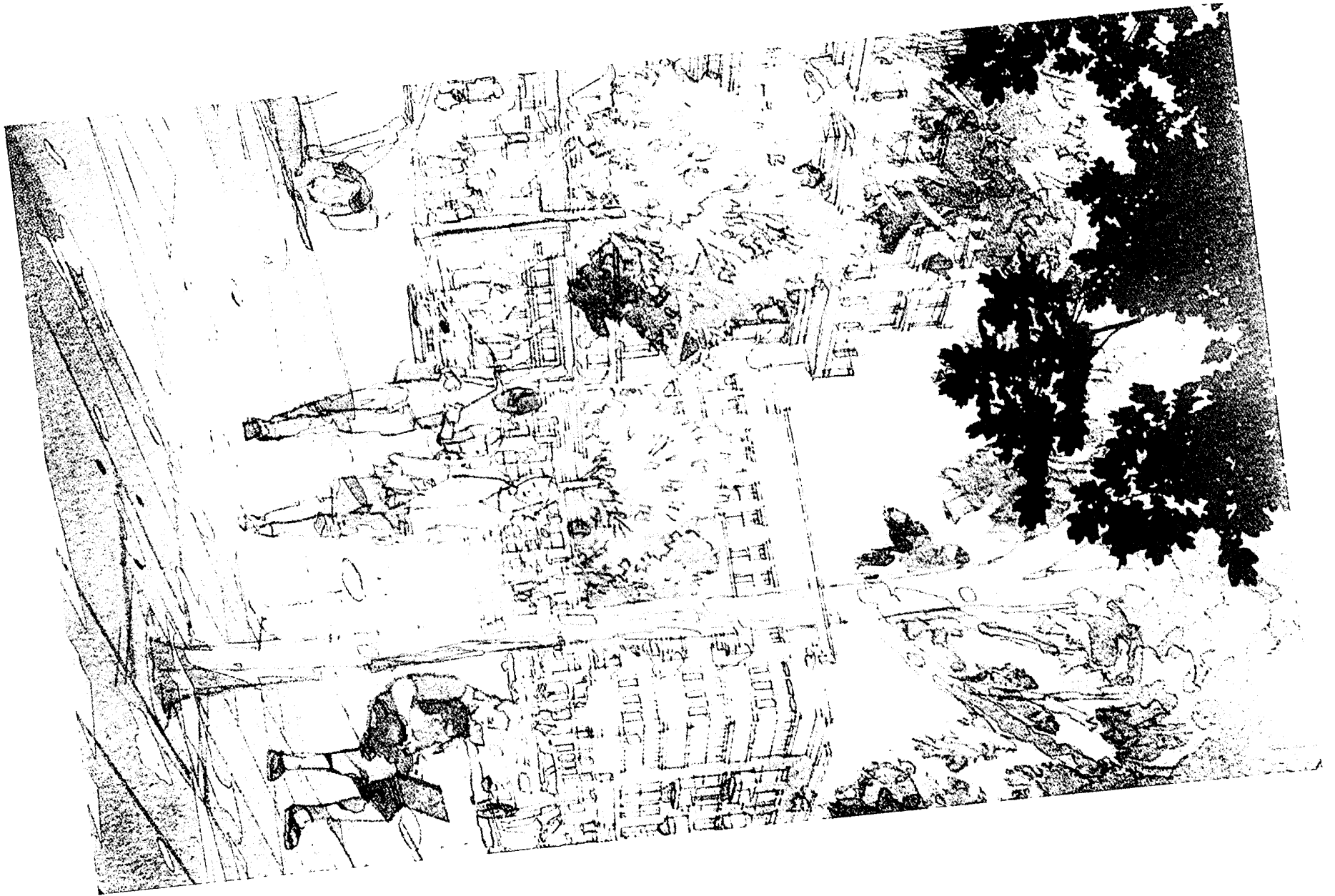

**WEST FARM/SOUTH FARM
MASTER PLAN SUMMARY**

WEST FARM/SOUTH FARM MASTER PLAN

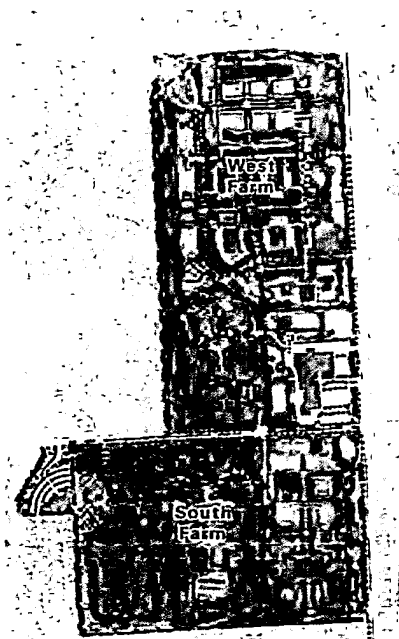

The West Farm/South Farm Master Plan is a dramatic new mixed-use development in western Omaha, offering a rich and diverse lifestyle for residents, office workers, and visitors. The plan integrates many aspects of life into a compact, walkable village with safe, comfortable, and interesting streets, parks, and activities. The West Farm/South Farm Master Plan includes 1,400,00 SF of office; 819,000 of retail; 1,600 multi-family units; 144 townhouses; and 290 single family units.

MIXED-USE DISTRICTS

The core of the project is a pleasant shopping and dining district located in West Farm with a wide selection of restaurants and retailers. Designed for those who love urban life, upstairs apartments and office lofts will further animate the center. A shopping center for fashion and home furnishing retailers is located in the northern area near Dodge Road within easy walking distance of nearby offices and the core. South of Pacific Street is a neighborhood oriented shopping and office district with a major grocer, restaurants, and shops.

RESIDENTIAL NEIGHBORHOODS

Here, the residential neighborhoods set themselves apart by creating a walkable environment based on the finest Omaha neighborhoods from the early 20th century. The houses will be modeled after Omaha's great Tudor, Craftsman, and Colonial houses. Garages will be alley loaded so that streets can be lined with porches, authentic facades, and gardens instead of being lined with garage doors.

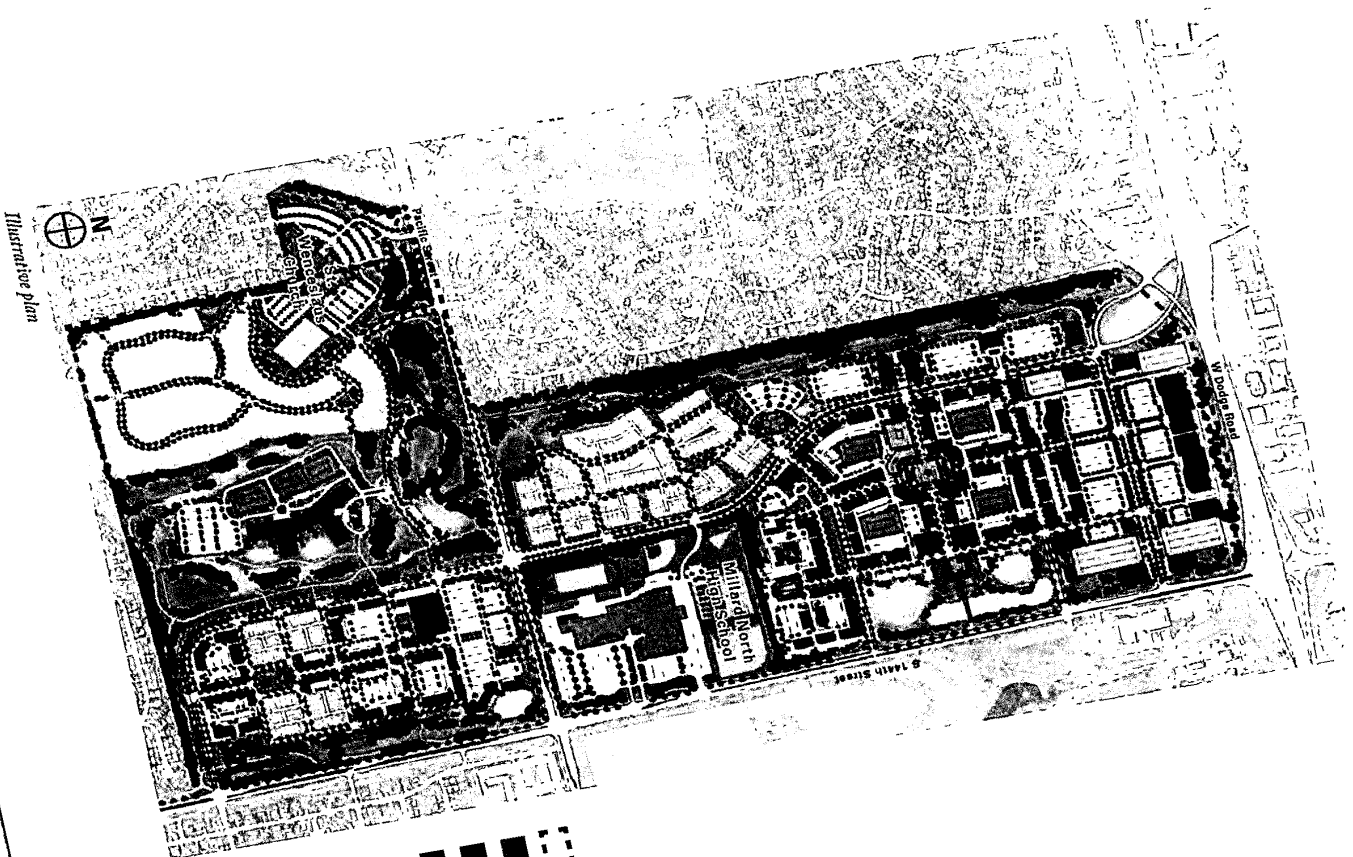

- SITE BOUNDARY
- OFFICE
- MIXED USE
- RETAIL
- HOTEL
- MULTI-FAMILY RESIDENTIAL
- SINGLE-FAMILY RESIDENTIAL
- INSTITUTIONAL
- PLATFORM PARKING
- STRUCTURED PARKING

EXECUTIVE SUMMARY

01 MAR 2017

DESIGN AND DEVELOPMENT PRINCIPLES

West Farm/South Farm presents a unique opportunity for enriching western Omaha with a new mixed-use walkable development consisting of several neighborhoods and districts. The following design and development principles were followed in the design process.

DESIGN AND DEVELOPMENT PRINCIPLES
<p>1. CREATE A 24/7 PEDESTRIAN-FRIENDLY ENVIRONMENT</p> <ul style="list-style-type: none"> » Build compact pedestrian friendly mixed-use neighborhoods » Locate many activities of daily living within walking distance » Build interconnected streets to encourage walking and to reduce the number and length of automobile trips, and conserve energy. » Build trails that provide pleasant walking and biking routes connecting to all neighborhoods and adjacent communities. <p>2. PROVIDE A MIX OF USES</p> <ul style="list-style-type: none"> » Office Park » Mixed-use commercial center with retail, residential, and office » Apartment neighborhoods » Single-family neighborhood » Corporate campus for Applied Underwriters » Neighborhood shopping district » Civic parks » Extensive trail network <p>3. PROVIDE A RANGE OF HOUSING CHOICES</p> <ul style="list-style-type: none"> » Urban center apartments and condominiums » Apartment communities » Mansion apartments » Townhouses » Urban single-family houses » Large houses and mansions <p>4. CREATE A UNIQUE RANGE OF PUBLIC SPACES</p> <ul style="list-style-type: none"> » Gateway park with an amphitheater and lake » Farm-to-table garden and dining district » Public square » Residential neighborhood parks » Ravines and natural areas » Trails <p>5. PROVIDE SHARED PARKING AREAS SCREENED FROM PUBLIC STREETS</p> <p>6. DESIGN URBAN BUILDINGS</p> <ul style="list-style-type: none"> » Buildings should define streets and public spaces as places of shared use » Commercial buildings should animate and enrich public streets » Houses should be designed based on Omaha's great residential neighborhoods with beautiful facades, porches, and landscaping — no garage doors facing the street

EXECUTIVE SUMMARY

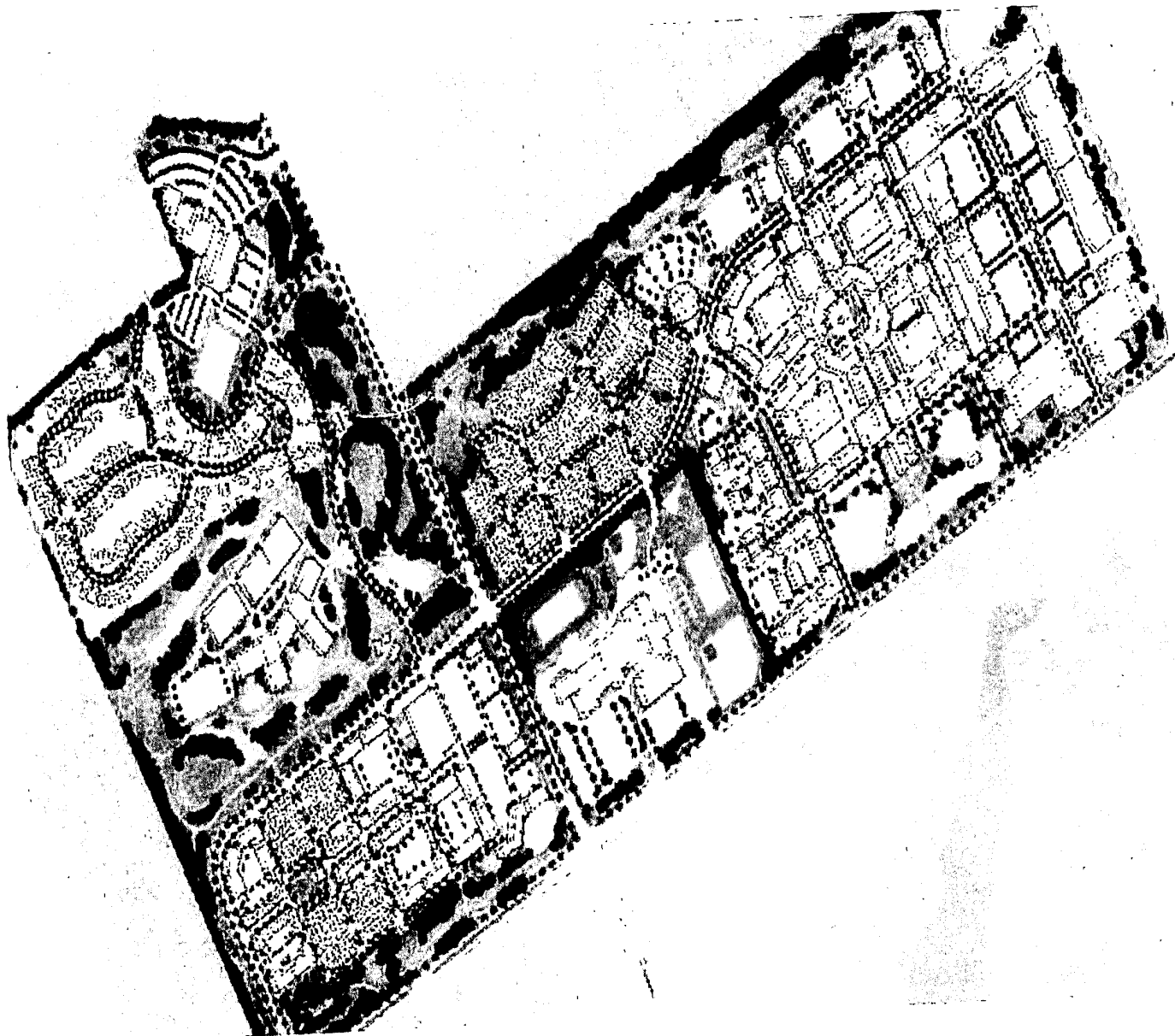





WEST FARM MASTER PLAN

WEST FARM MASTER PLAN

The West Farm Master Plan is a dramatic new mixed-use development in western Omaha, offering a rich and diverse lifestyle for residents, office workers, and visitors. The plan integrates many aspects of life into a compact, walkable village with safe, comfortable, and interesting streets, parks, and activities.

MIXED USE DISTRICTS

The core of the project is a pleasant shopping and dining district located in West Farm with a wide selection of restaurants and retailers. Designed for those who love urban life, upstairs apartments and office lofts will further animate the center. A shopping center for fashion and home furnishing retailers is located in the northern area near Dodge Road within easy walking distance of nearby offices and the core. South of Pacific Street is a neighborhood oriented shopping and office district with a major grocer, restaurants, and shops.









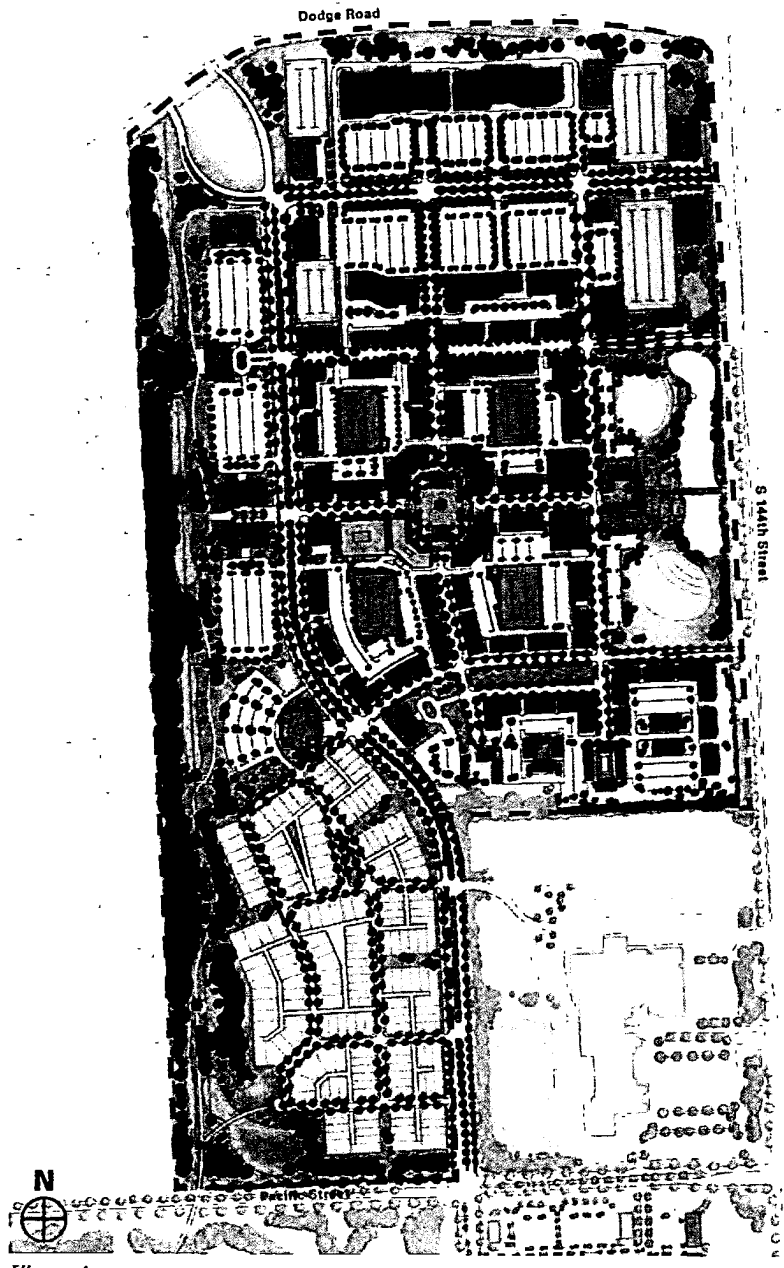

RESIDENTIAL DISTRICTS

Here, the residential neighborhoods set themselves apart by creating a walkable environment based on the finest Omaha neighborhoods from the early 20th century. The houses will be modeled after Omaha's great Tudor, Craftsman, and Colonial houses. Garages will be alley loaded so that streets can be lined with porches, authentic facades, and gardens instead of being lined with garage doors.

West Farm Master Plan Development Quantities

District	Office (SF)	Retail (SF)	Hotel (Rooms)	Institutions (SF)	Multi-Family (Units)	Townhouse (Units)	Single Family (Units)
Residential	—	—	—	—	—	—	162
Mixed-Use	948,100	652,910	300	25,300	1,285	25	—
Total	948,100	652,910	300	25,300	1,285	25	162



-  SITE BOUNDARY
-  OFFICE
-  MIXED USE
-  RETAIL
-  HOTEL
-  MULTI-FAMILY RESIDENTIAL
-  SINGLE-FAMILY RESIDENTIAL
-  INSTITUTIONAL
-  PLATFORM PARKING
-  STRUCTURED PARKING

WEST FARM







**WEST FARM MIXED-USE
DEVELOPMENT PLAN**

LAND USE PLAN

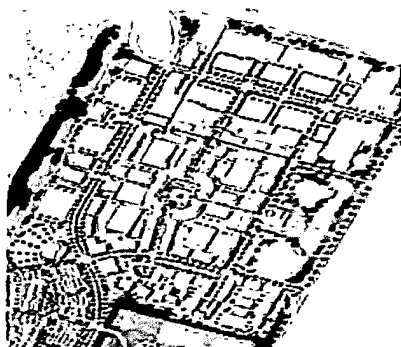

Aerial View of Mixed-Use District



View of Village Square

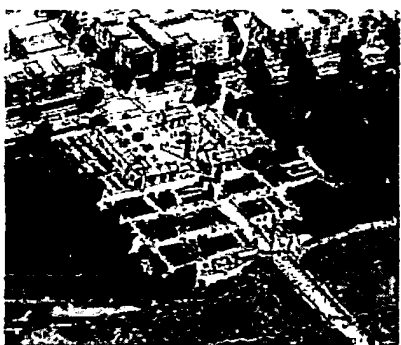

View of Historic Farm Buildings

The Land Use Plan consists of two types of land use districts: Mixed-Use and Residential. Both land use categories are found in West Farm as shown on the adjacent plan.

MIXED USE DISTRICT

The Mixed-Use District includes open space, the boulevard, and streets serving the district; 652,910 SF of retail; 948,000 SF of Commercial uses, including retail and office development, are concentrated in the highly visible northern part of West Farm.

RESIDENTIAL DISTRICT

Residential Districts include residential open space, streets serving residential units, multi-family and single family residential development. The Residential District is located in a quieter less visible area of West Farm adjacent to Millard North High School. The predominant land use in this district is single-family housing. This district is described in greater detail in the West Farm/South Farm Master Plan.

Table 4.1 Mixed Use District Development Summary Chart

Block	Multi-Family (Units)	Town (Units)	Office (SF)	Retail (SF)	Hotel (Room)	Institutional (SF)
B1	—	—	330,000	169,800	—	—
B4	—	—	110,000	—	—	—
B5	—	—	80,000	61,300	—	—
B6	—	—	—	89,000	—	—
B7	—	—	200,000	14,400	—	—
B8	—	—	50,000	—	—	—
B9	275	—	—	76,950	—	—
B10	147	—	98,100	91,850	—	—
B11	—	—	—	25,000	—	—
B12	—	—	50,000	—	—	—
B13	198	—	—	48,900	300	—
B14	309	—	—	73,410	—	—
B15	—	—	—	—	—	25,300
B16	—	—	30,000	—	—	—
B17	103	17	—	—	—	—
B18	253	8	—	2,300	—	—
Total	1,285	25	948,100	652,910	300	25,300

DRAFT | 01 MAR 2017

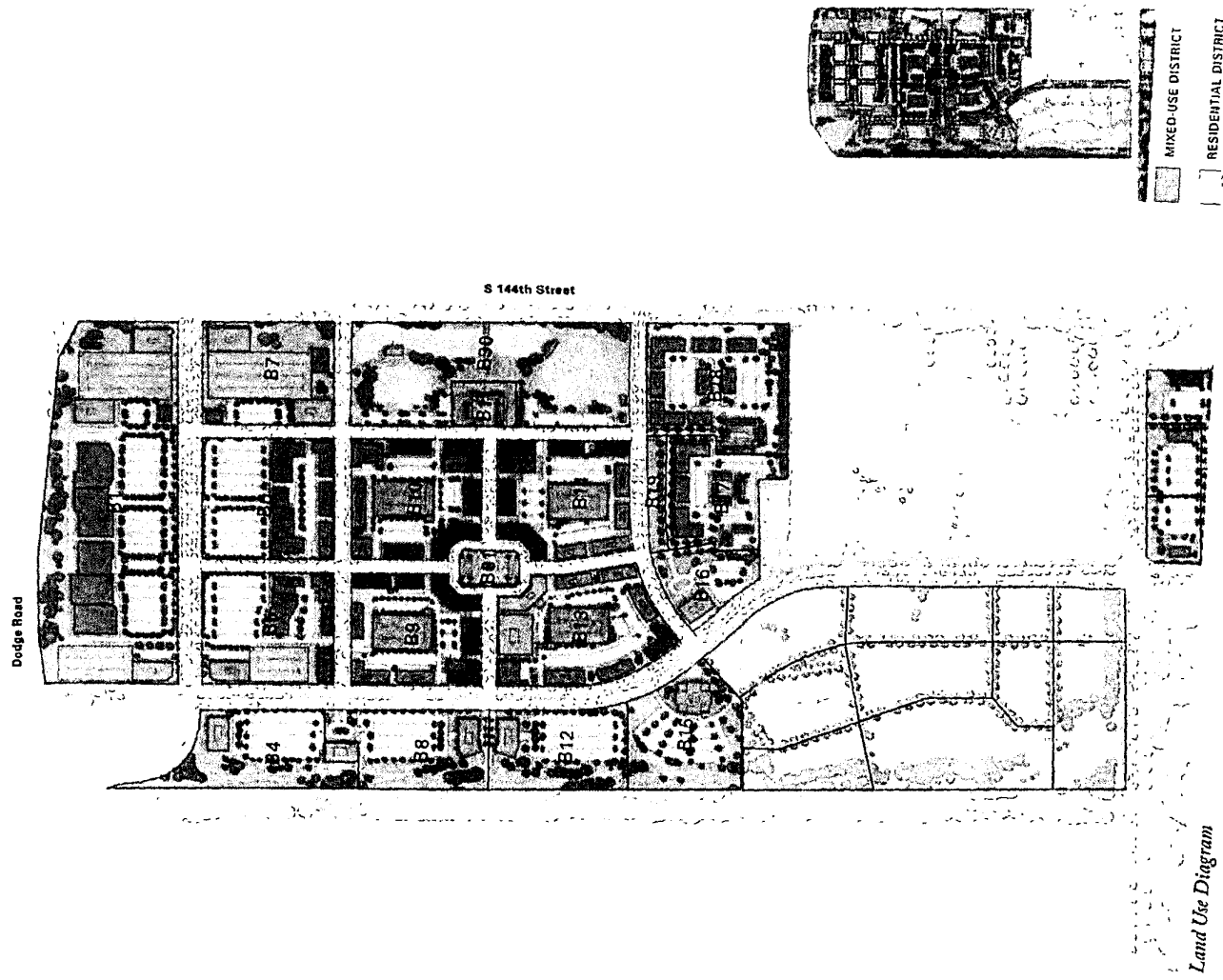

Land Use Diagram

MASSING DIAGRAMS

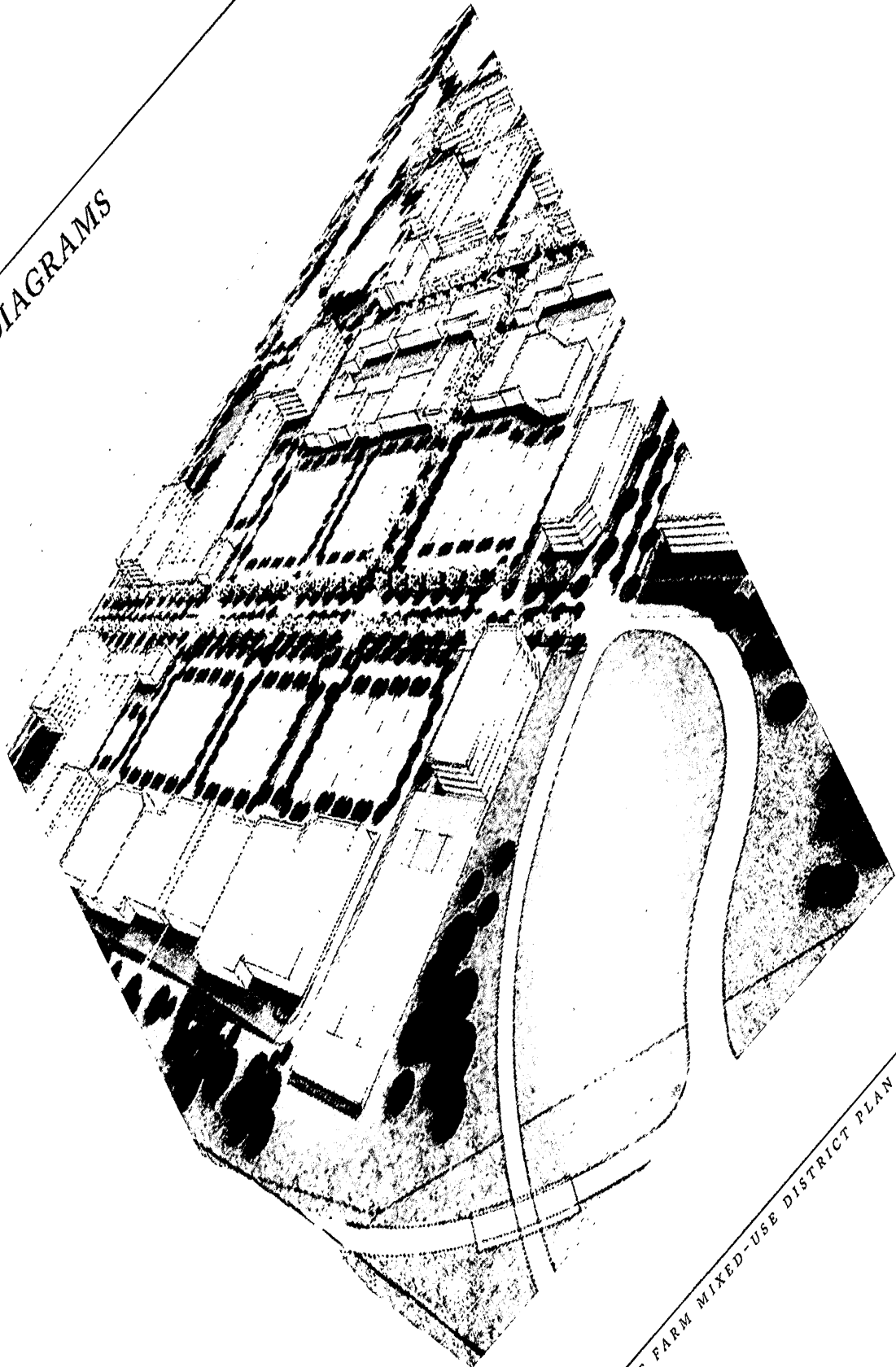

View of Mixed-Use town center

WEST FARM MIXED-USE DISTRICT PLAN

DRAFT | 01 MAR 2017

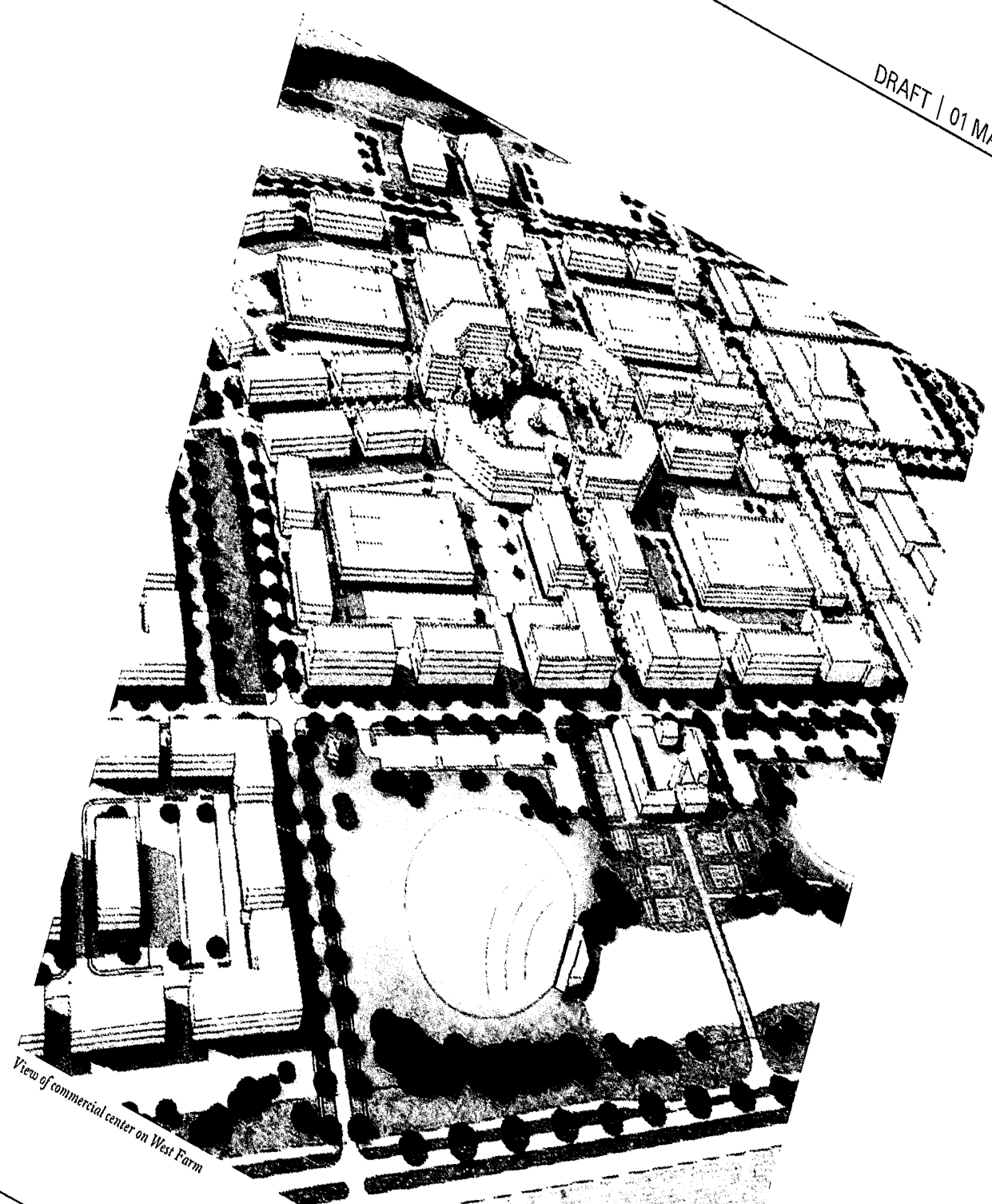

View of commercial center on West Farm

WEST FARM MIXED-USE DISTRICT GUIDELINES

LANDMARKS, FOCAL POINTS, AND AXES

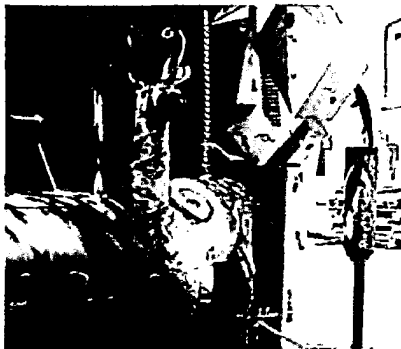

Omaha has a rich tradition of supporting local artists



Existing landmarks on site



Existing landmarks on site

The townscape of West Farm is designed to take advantage of key view corridors and points of convergence.

GATEWAYS

Major approaches to West Farm from Dodge Rd and Pacific St will have gateway landmarks to announce entry. These may include signs, pavilions, works of art, and special landscapes. Buildings at prominent entries should be designed with corner features and interesting roofscapes to further define the entry experience.

AXIS

View corridors orient visitors to key destinations and animate their experience with visual cues. Major view corridors both north/south and east/west draw visitors to Village Square, the heart of the mixed-use village center in West Farm.

LANDMARKS

Landmarks include highly visible buildings, pavilions, sculptures, signage, and fountains that terminate view corridors or dominate places. One example is the proposed farm cluster at the head of the shopping street facing 144th St.



Perspective showing farm building focal points



- 1 Public Art
- 2 Architectural Feature
- 3 Signage
- 4 Architectural Feature
- 5 Signage
- 6 Public Art/Signage
- 7 Vertical Element
- 8 Featured Farm Buildings
- 9 Architectural Feature
- 10 Signage
- 11 Pavilion
- 12 Signage
- 13 Gateway Pedestrian Bridge
- 14 Architectural Feature

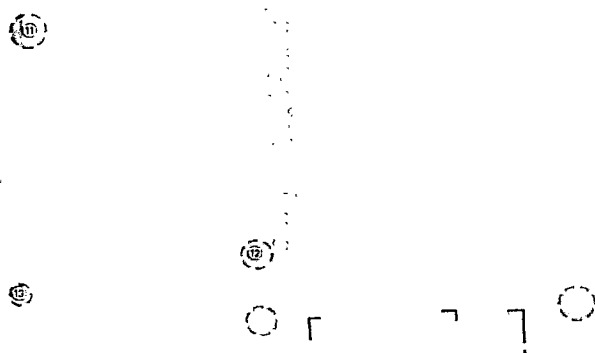
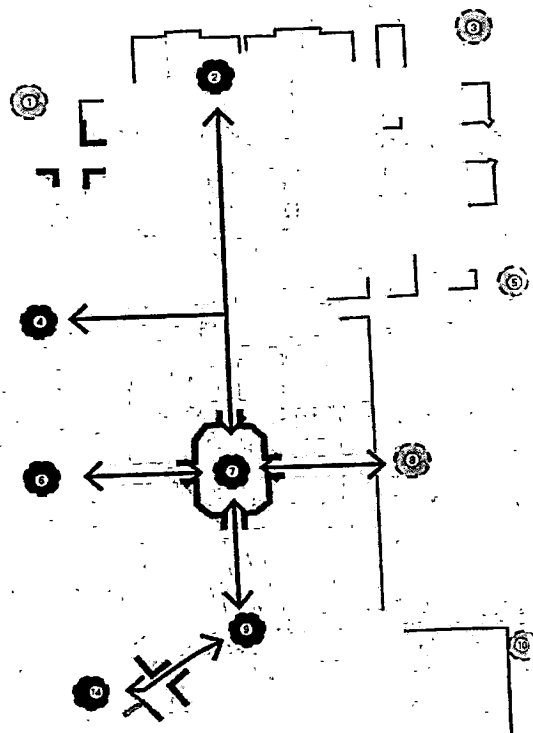

Landmarks, Focal Points, and Axes Diagram

- GATEWAY LANDMARK
- HIDDEN TREASURES
- LANDMARKS TERMINATING AXES
- IMPORTANT CORNERS
- MAJOR AXIS
- VISIBLE FROM DODGE OR 144TH

OPEN SPACE SYSTEM



Village Square showing a farmers market



Village Square informal sitting areas

West Farm will have a rich variety of open spaces that comprise approximately one-third of the total land area of the property. The greenways, recreation areas, and urban squares will add a unique dimension to life for residents and workers in the new development.

GREENWAYS

These spaces are remnants of the agricultural lands and forested areas that buffer the development from adjacent districts and neighborhoods. These areas are used for trails and stormwater detention and are mostly passive in character.

RECREATION AREAS

These are highly programmed open spaces designed for passive daily use and special events such as festivals and concerts. The Central Area will be the most civic in nature similar to Stinson Park in Aksarben. The residential neighborhood will have small recreation spaces with play areas designed for families and children.

PUBLIC SQUARES

Village Square will be the center of village life. It is designed with pavement, strategically placed shade trees, and configured to accommodate a range of festivals, markets, concerts, and seasonal events. Other smaller squares will be located for outdoor dining and to create pedestrian passages.



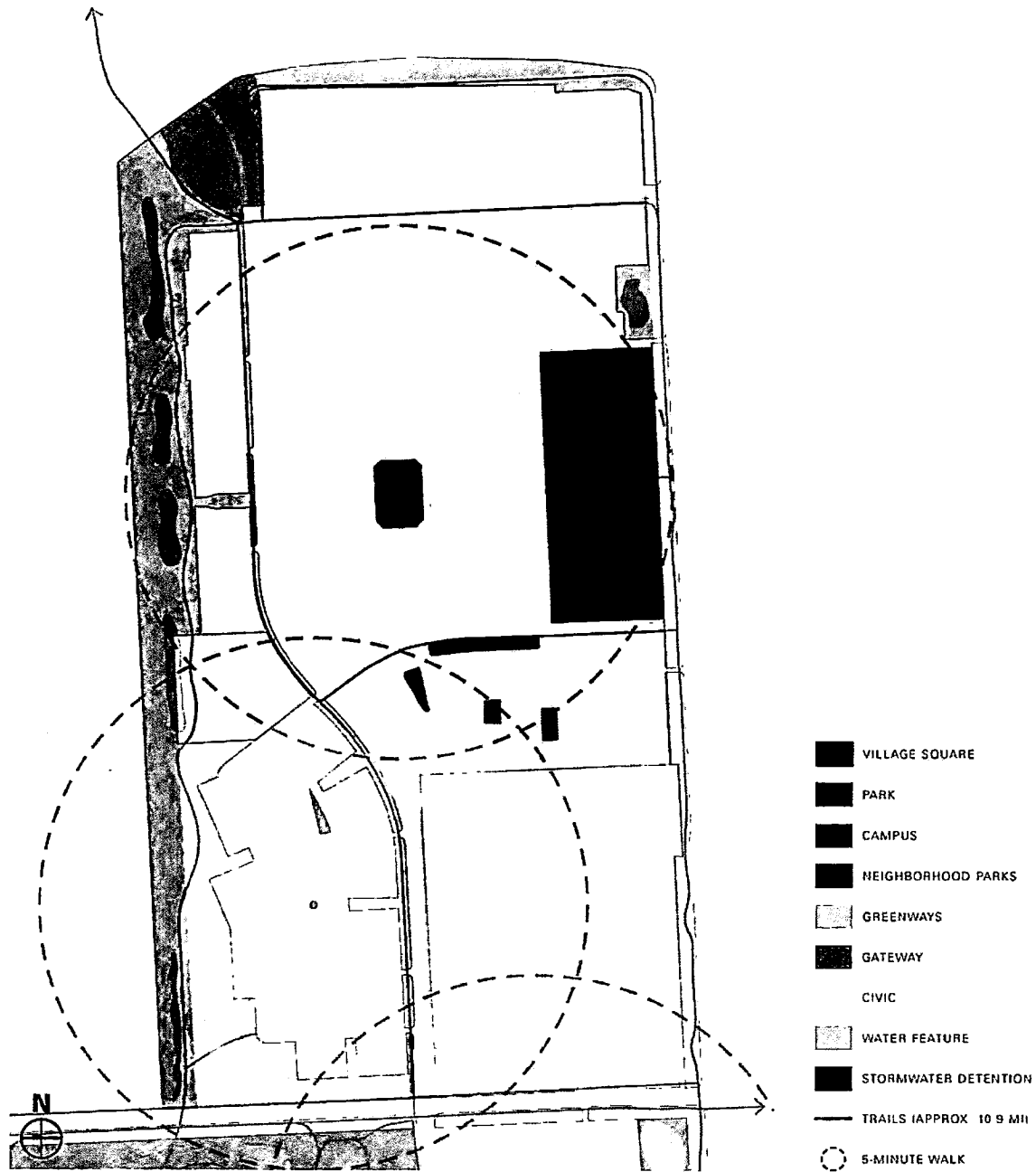

Open Space System Diagram

OPEN SPACES IN WEST FARM

GREENWAY

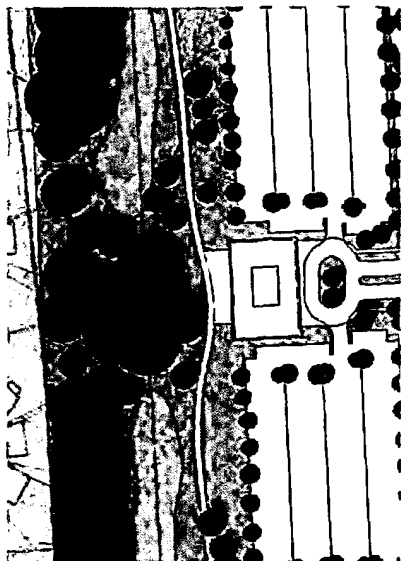

Partial plan of a Greenway



Example of a Greenway environment

NEIGHBORHOOD SQUARE

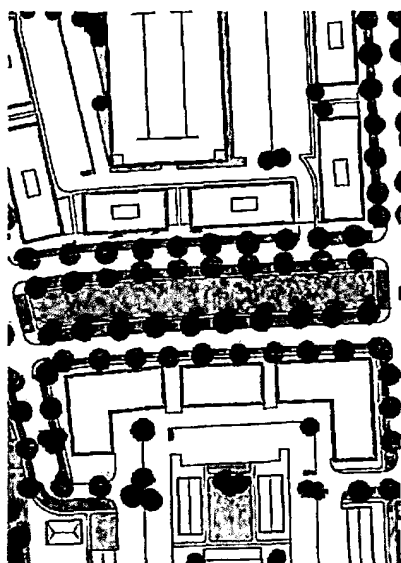

Plan of Neighborhood Square



Perspective of Neighborhood Square



RECREATION AREA

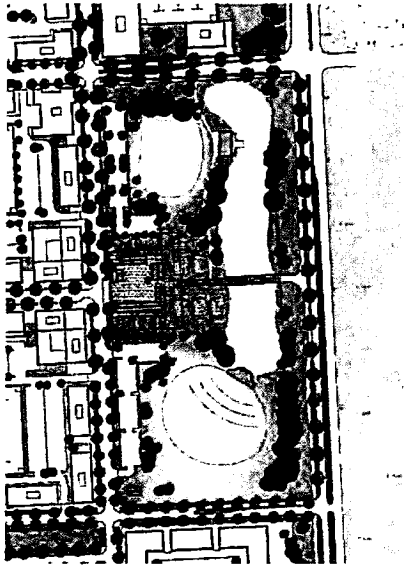

Plan of Central Recreation Area



Perspective of Central Recreation Area

VILLAGE SQUARE

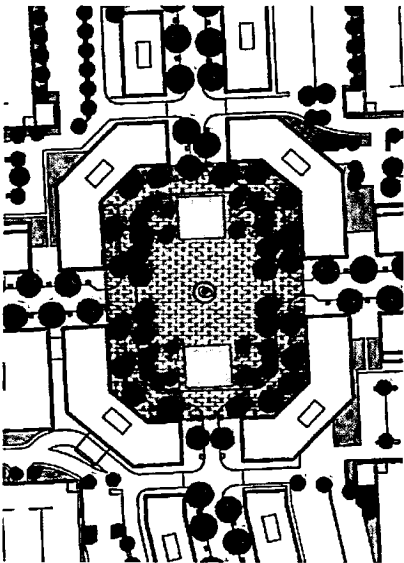

Plan of Village Square



Perspective of Village Square

TRAIL SYSTEM

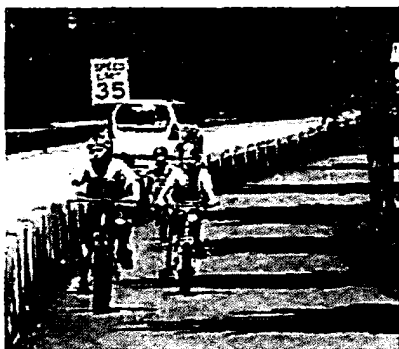

Multi-use trails will parallel streets

One of the most distinguishing qualities of the West Farm plan is the extensive trail network that has been integrated into the design. The trail system will offer running, walking, and biking routes of differing lengths with an endless combination of distances. Trails are located to take advantage of the extensive open space system passing from one park and recreation area to the next. Some of the trails will follow along the Boulevard and other important streets in West Farm as separated multi-use paths. Other trails will follow along stream courses in the greenway in more pastoral settings.



Other trails will meander through natural areas



Trails will connect residents and office workers with commercial centers



Multi-use trails will be integrated into the design of streets

DRAFT | 01 MAR 2017

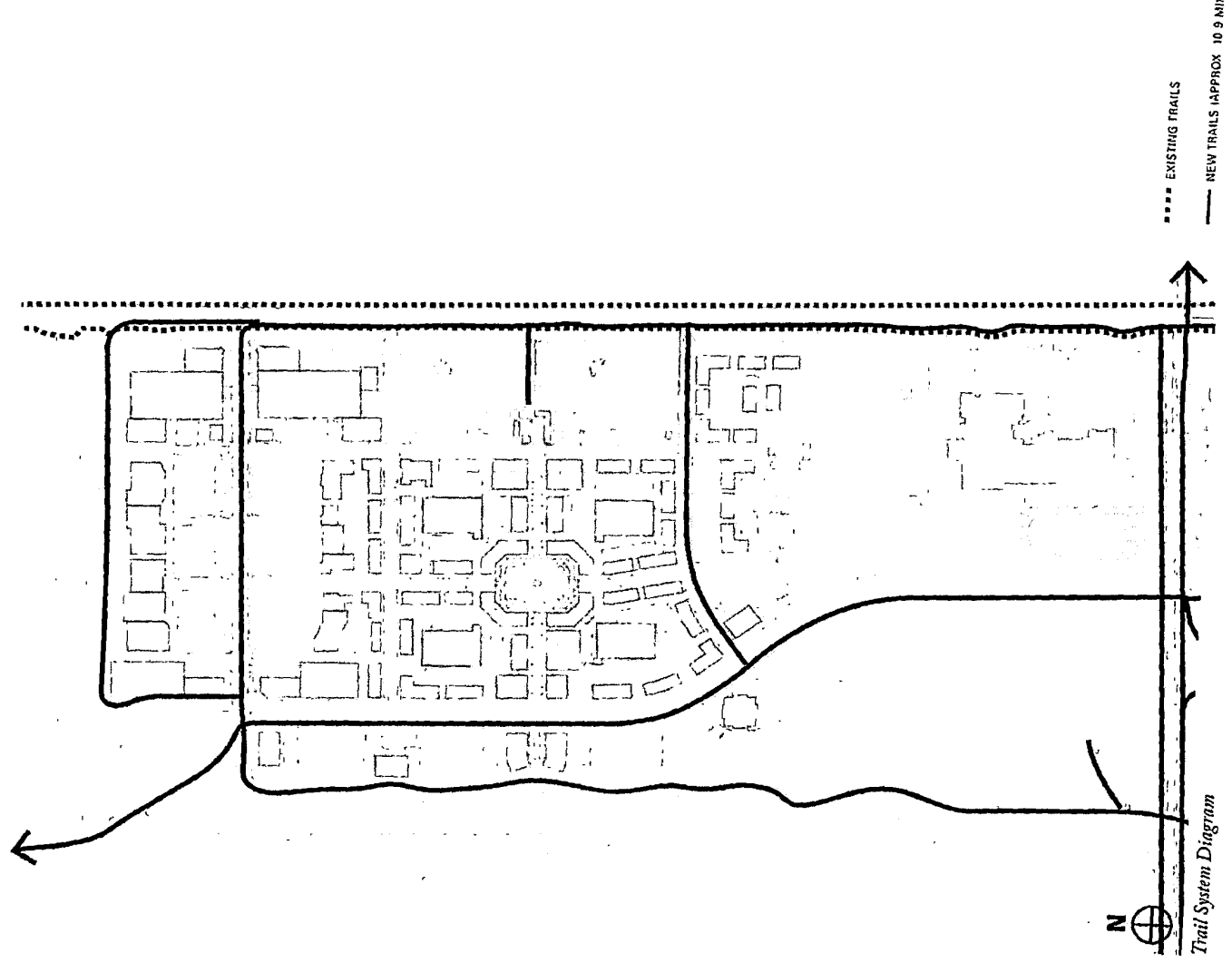

WEST FARM MIXED-USE DISTRICT GUIDELINES

STREET TYPES



Perspective of new mixed-use street



Example of a Residential Street



Example of a Commercial Street

The street network in West Farm/South Farm is organized into a grid pattern to create walkable communities and to provide motorists with many choices to navigate the site. New streets built on the West Farm/South Farm properties will contribute to overall mobility in western Omaha by expanding the street network and creating alternative routes. Currently, a considerable amount of traffic uses Dodge Rd, 144th St, and Pacific St for daily commuting and regional access. The development will add additional trips to the network but will also expand it. Improvements to existing intersections include a new interchange at 150th St and Dodge Rd, as well as the widening of 144th St and Pacific St. A new north/south parkway will parallel 144th St connecting the interchange at Dodge Rd and 150th St with Pacific St just west of Millard North High School and will proceed further south to 144th St. New streets within the site will accommodate the traffic generated by the new development.

Street designs are influenced by the land uses they serve and are conceived as “complete streets.” These are streets designed as beautiful public spaces, with accommodation for motor vehicles, bicycles, pedestrians, street furniture, utilities, and landscaping. The development has the following street types:

- » Dodge Road
- » 144th Street
- » Pacific Street
- » The Boulevard
- » Commercial Boulevard
- » Mixed-Use Streets
- » The Village Square
- » Multi-Family District Streets
- » Residential Neighborhood Streets

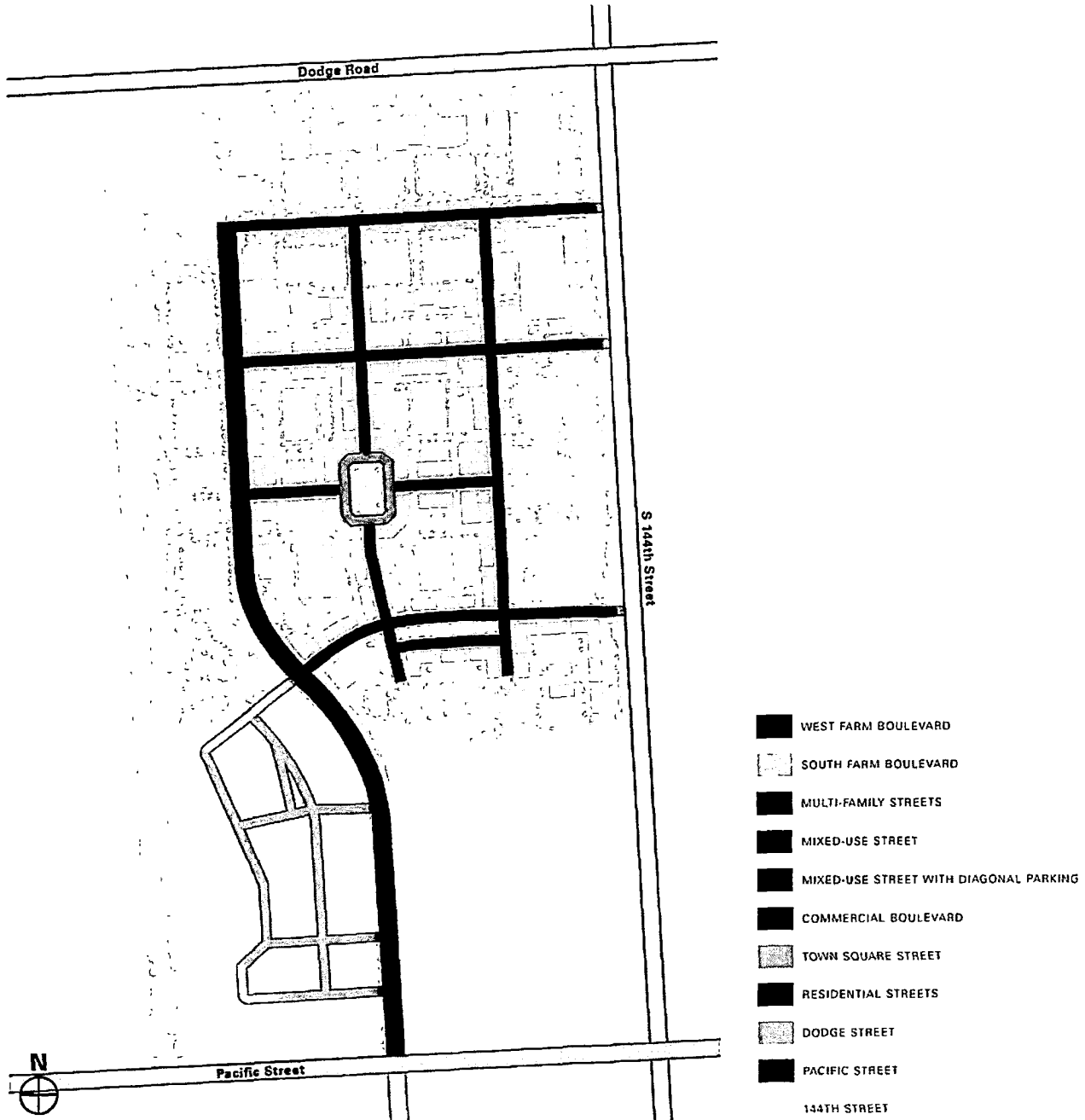

Street Type Diagram

STREET TYPES

West Farm Boulevard

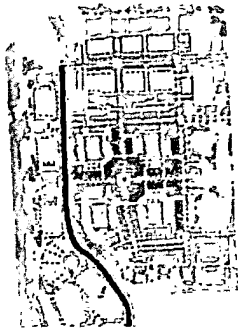

West Farm Boulevard is the major circulation spine for the West Farm development, extending from the interchange at 150th St and Dodge Rd to Pacific Street west of Millard North High School. The Boulevard is a “complete street,” designed with two travel lanes in each direction and left turn lanes at the intersection. West Farm Boulevard runs parallel to 144th St and will distribute traffic to reduce congestion in the road network. It will provide access to the mixed-use and residential districts.

The design includes a generous landscaped median and deep tree lawns (verges) between the roadway, and pedestrian walks creating the impression of a continuous greenway. A 14-foot multi-use trail follows the Boulevard the entire length for use by cyclists and pedestrians.

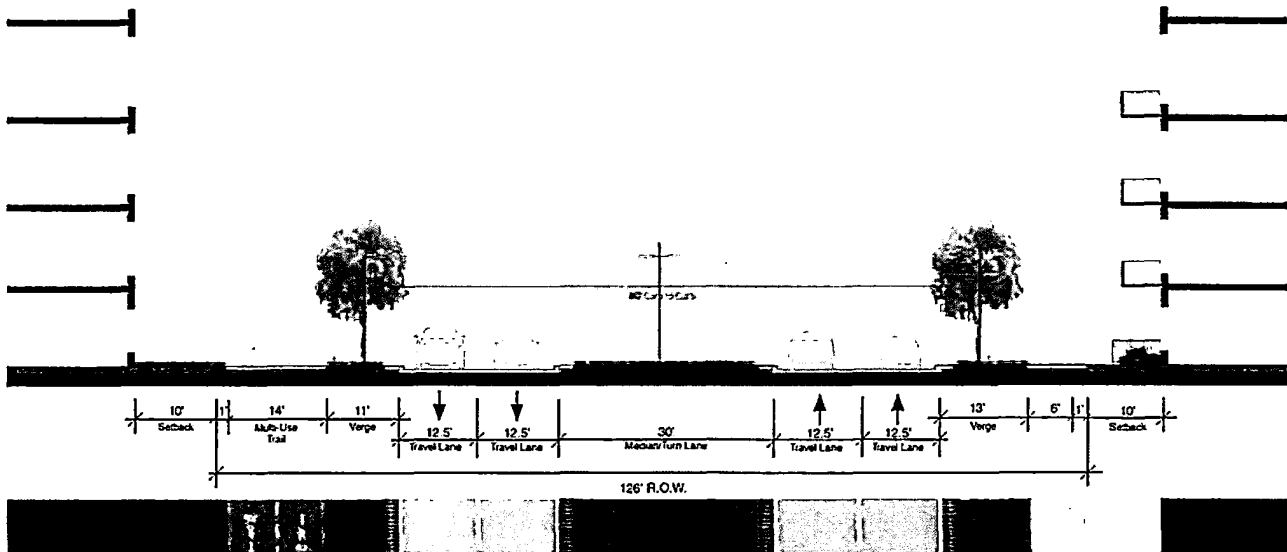

Section



Commercial Boulevard

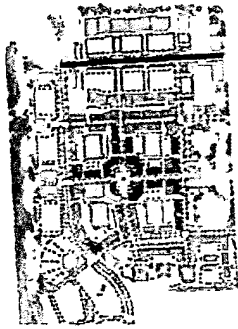

Commercial Boulevard is the central road serving the office park and regional retail center in the northern part of West Farm, proceeding east/west from the interchange at 150th St and Dodge Rd to 144th St. Given the large parking requirements for both the retail stores and office buildings, this street is designed as a four-lane boulevard with turn lanes for easy access to parking areas. The 126-foot right-of-way provides space for gateway landscaping and sidewalks that will create an attractive address for the development. The 20-foot setbacks beyond the boulevard right-of-way will provide plenty of space for additional landscaping to buffer views of the parking lots.

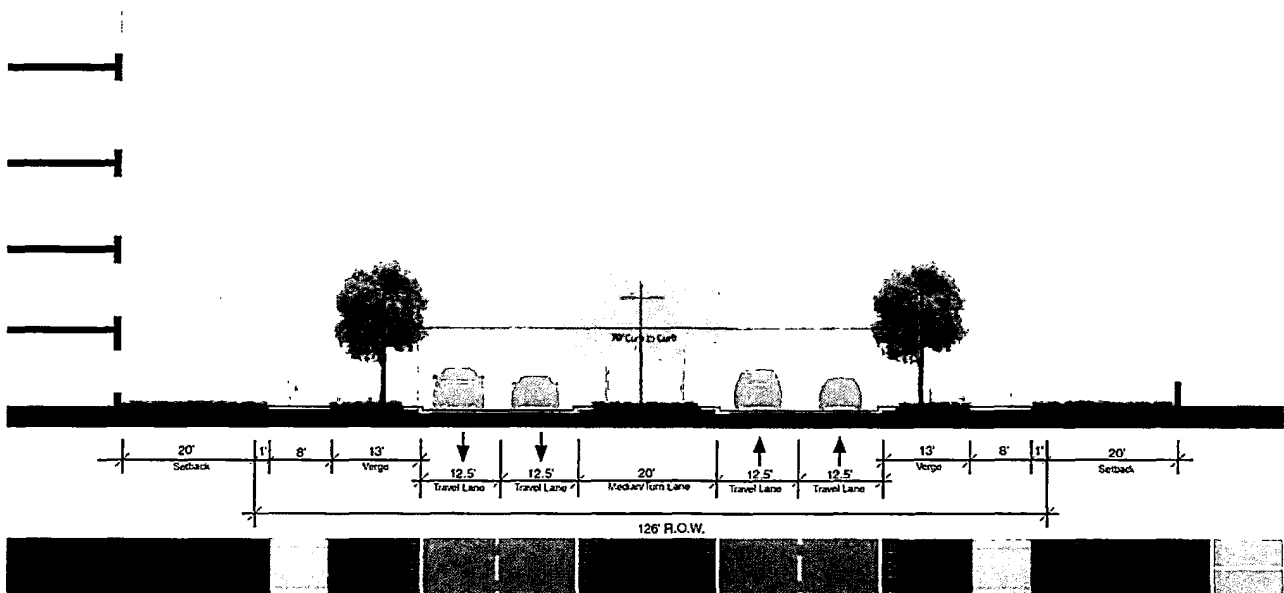

Section

MIXED-USE DISTRICT STREETS

Mixed-Use Street — Parallel Parking

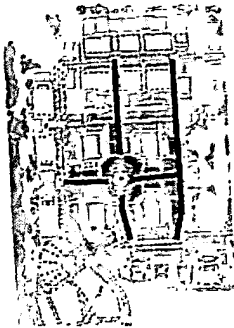

A majority of streets in the village center are two lane streets with parallel parking on both sides. The sidewalks are approximately 15 feet deep with areas for tree planting and pedestrian movement. In commercial areas, buildings are set back 10 feet to create a wider pedestrian realm for shopping and outdoor dining. The setback is an ideal location for outdoor cafes and retail displays. This area also permits overhanging signage, awnings, and balconies without protruding into the street right-of-way. The building face to face dimension is very similar to traditional shopping streets across the US.

In residential areas of the village center the 10-foot setback creates a front yard zone and place for transitioning from sidewalk level to residential floor level.

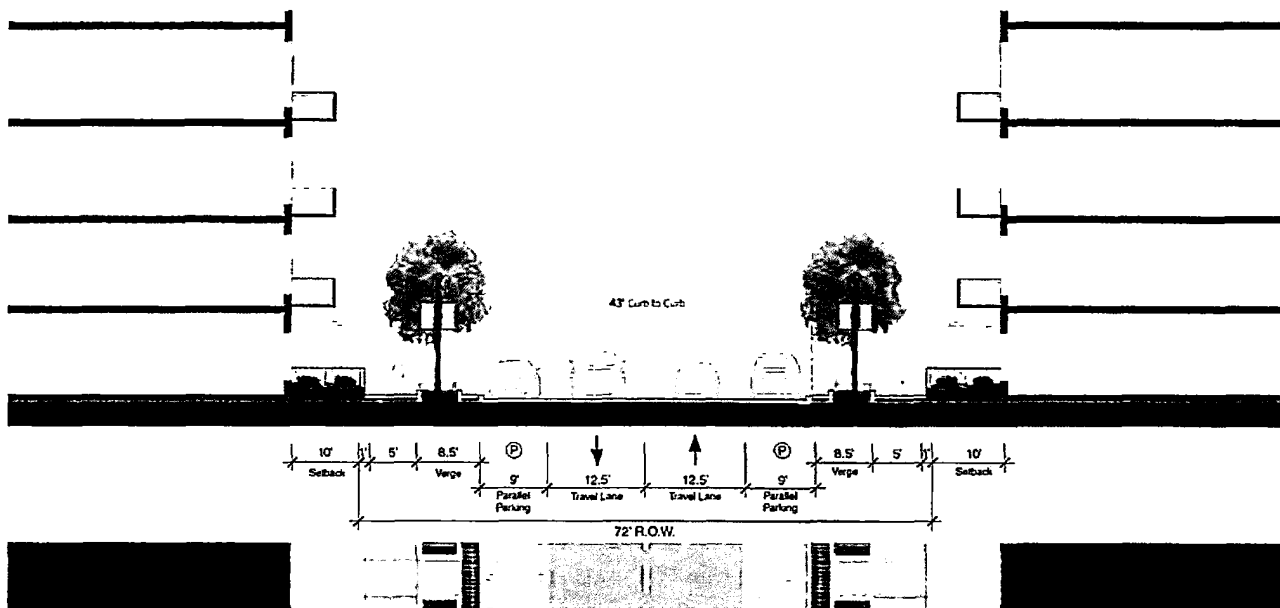

Section



Mixed-Use Street — Diagonal Parking

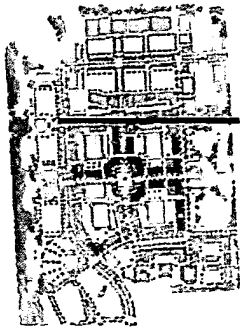

This two lane shopping street has diagonal parking on both sides. Occasionally, parking spaces are replaced with large planting areas for street trees and ground cover to partially conceal the adjacent diagonally parked cars. The sidewalks are approximately 10 feet wide providing space for pedestrian circulation and street furnishings. In commercial areas, buildings are set back 10 feet to create a wider pedestrian realm for shopping and outdoor dining. The setback is an ideal location for outdoor cafes and retail displays. This area also permits overhanging signage, awnings, and balconies without protruding into the street right-of-way. The building face to face dimension is very similar to traditional shopping streets across the US.

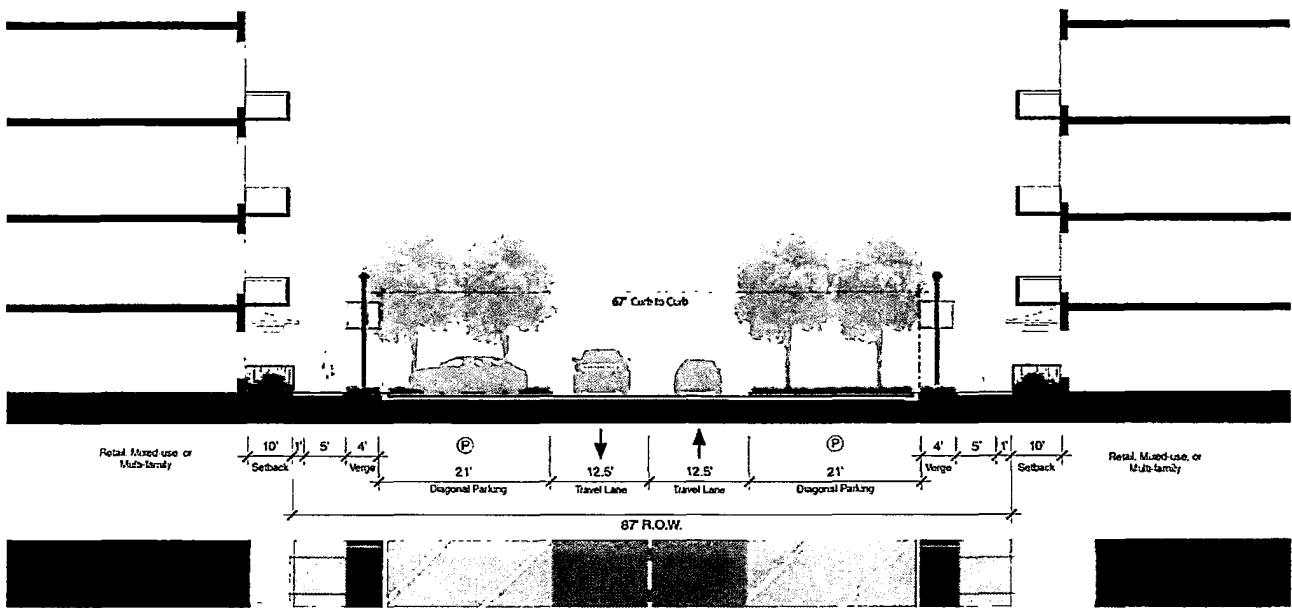

Section

MIXED-USE DISTRICT STREETS

Town Square Street

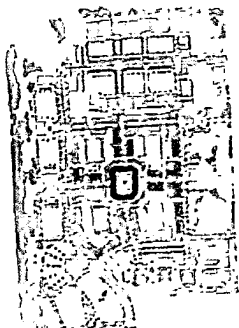

The Town Square is a unique public space that is designed to be pedestrian dominant. The Town Square will be the central event space that will host markets, concerts, public rallies, and other programmed events. On occasion the square may be closed off to traffic to enable activities to expand from wall to wall. To achieve maximum flexibility the surface will be flat, designed without curbs to reduce tripping hazards.

The design of the vehicular lanes should signal to the motorist that they must slow down and yield to pedestrians. The lanes will be identified with special paving and bollards.

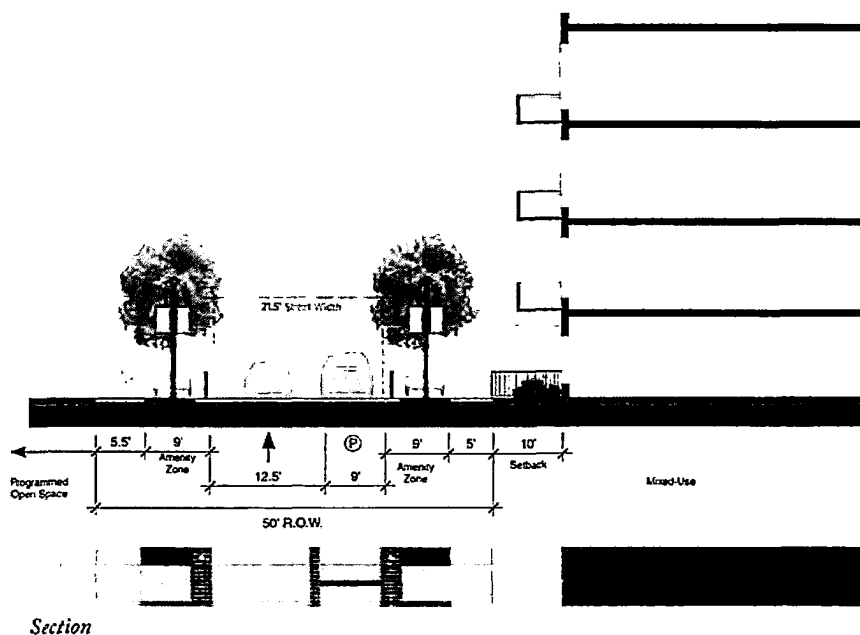

Section



Multi-Family Street

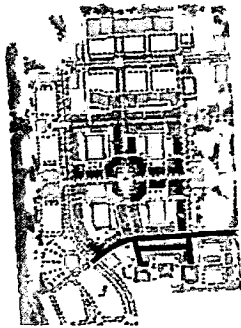

Apartment districts in West Farm will need easy access for a higher concentration of activity that would be found in single-family neighborhoods. Apartment streets are similar in design to Commercial streets but with more landscaping and less sidewalk area. On-street parking is provided for visitors and ground floor retail uses that may be found in apartment developments. Buildings are set back 10 feet from the street right of way line to create space for front yard landscaping to separate residential units from sidewalks. Trees are planted in continuous landscaped verges. Trees are planted in continuous landscaped verges.

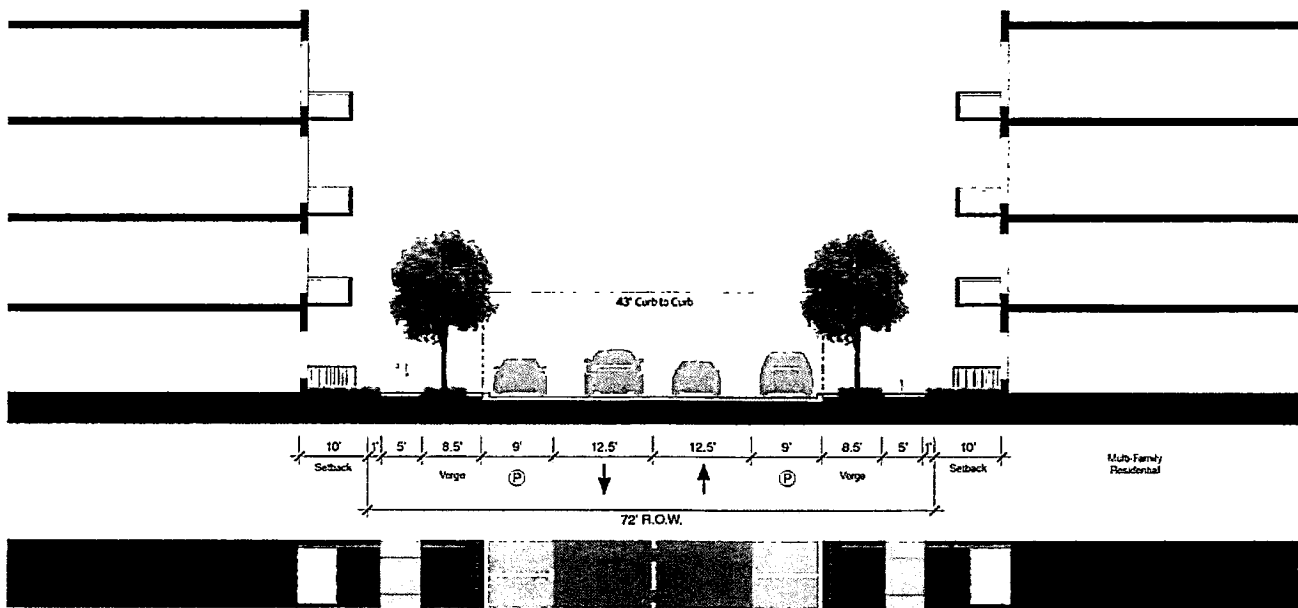

Section

MIXED-USE DISTRICT STREETS

Service Alley

West Farm is designed with service alleys that provide access to commercial and mixed-use buildings. Service lanes should be dimensioned to accommodate delivery trucks and emergency vehicles. They are also used to provide access to visitor and accessible parking spaces adjacent to buildings, parking lots and parking garages. Service alleys also provide space for utilities including electricity, cable, gas, and water, taking pressure off of the street for routing these services. Each building will have utility service entries and space for garbage containers and delivery docks.

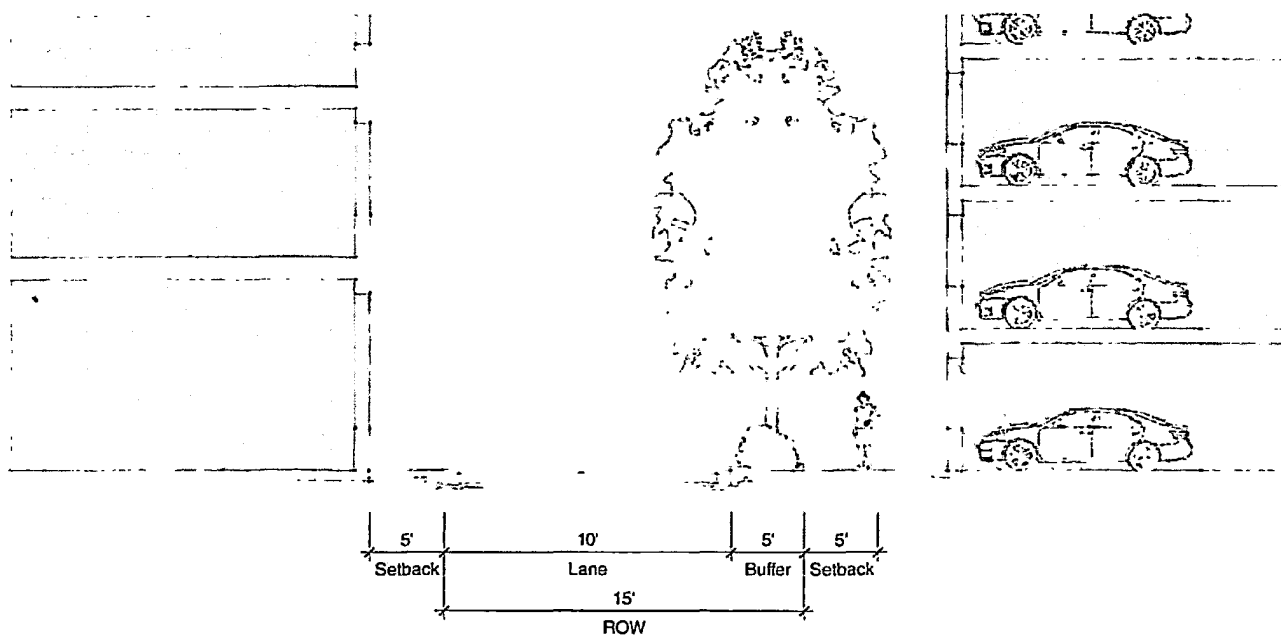

Street section for Service Lanes



Residential Alley



Example of Residential Alley

West Farm is designed with service alleys that provide access to lots for garages and parking areas. Service alleys also provide space for utilities including electricity, cable, gas, and water taking pressure off of the street for routing these services. Each lot will have utility service entries, parking, and space for garbage containers.

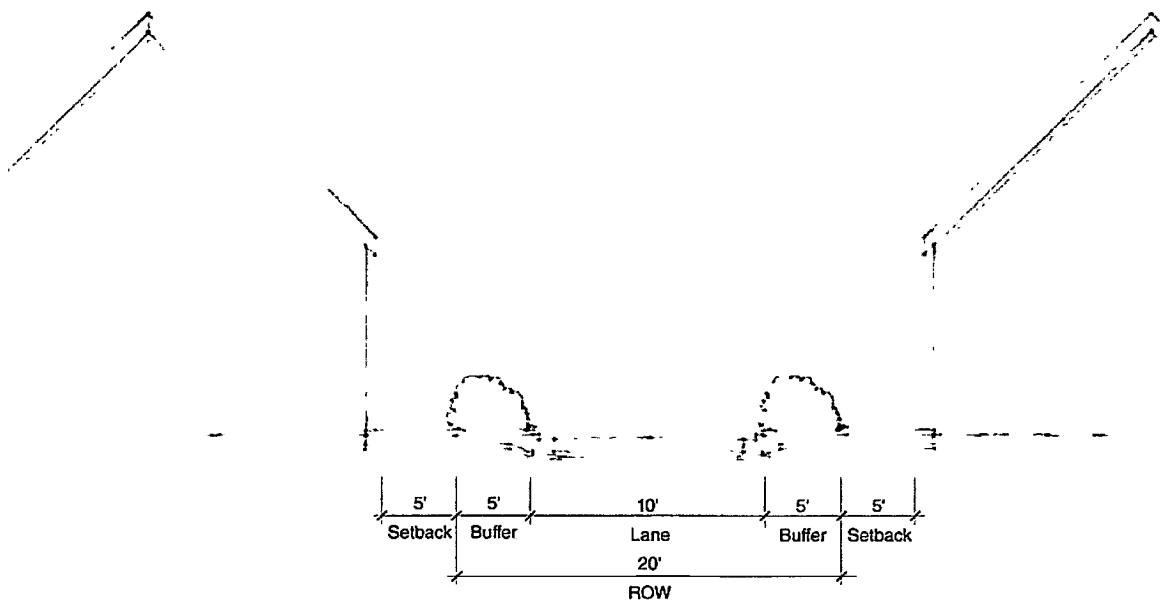

Street section for Residential Alleys

BUILDING SETBACKS



Examples of Residential Setback



Examples of Residential Setback



Examples of Commercial Setback



Examples of Commercial Setback

Most building setbacks in West Farm are 10 feet from the street right-of-way line. For commercial buildings, the 10-foot dimension is used in a couple of different ways. For office buildings without street related activity, a landscaped setback is recommended. For commercial and mixed-use buildings with active ground-floor uses connected to the street including retail offices, shops, and restaurants, the 10-foot setback provides additional sidewalk depth for outdoor retail, street signage, sidewalk cafes, and other outdoor activities. The setback provides space for elements that overhang the front facade of buildings including awnings, canopies, projecting signs, and balconies.

For houses, the setback is dimensioned to the front of the porch or the closest portion of the house facade. For apartment buildings, the setback is to the main building mass. In both single-family attached and detached buildings and apartment buildings, the 10-foot setback provides a front yard for landscaping and grade transitions. The first floor of residential buildings should always be set a couple of feet above sidewalk level to create additional privacy. Estate lot and mansion setbacks are a minimum of 20 feet.

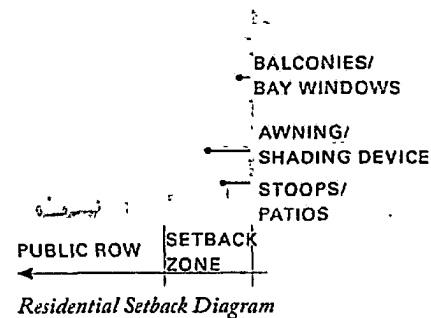
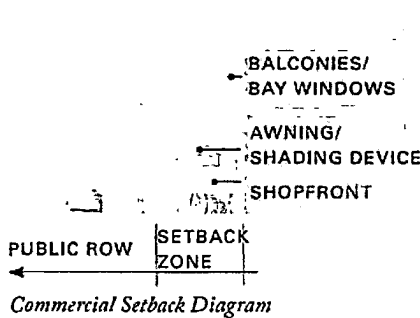

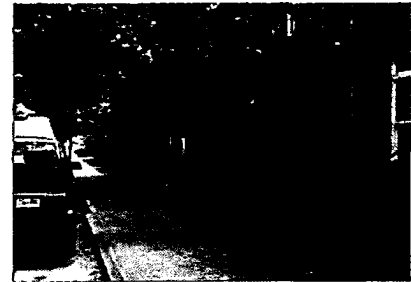
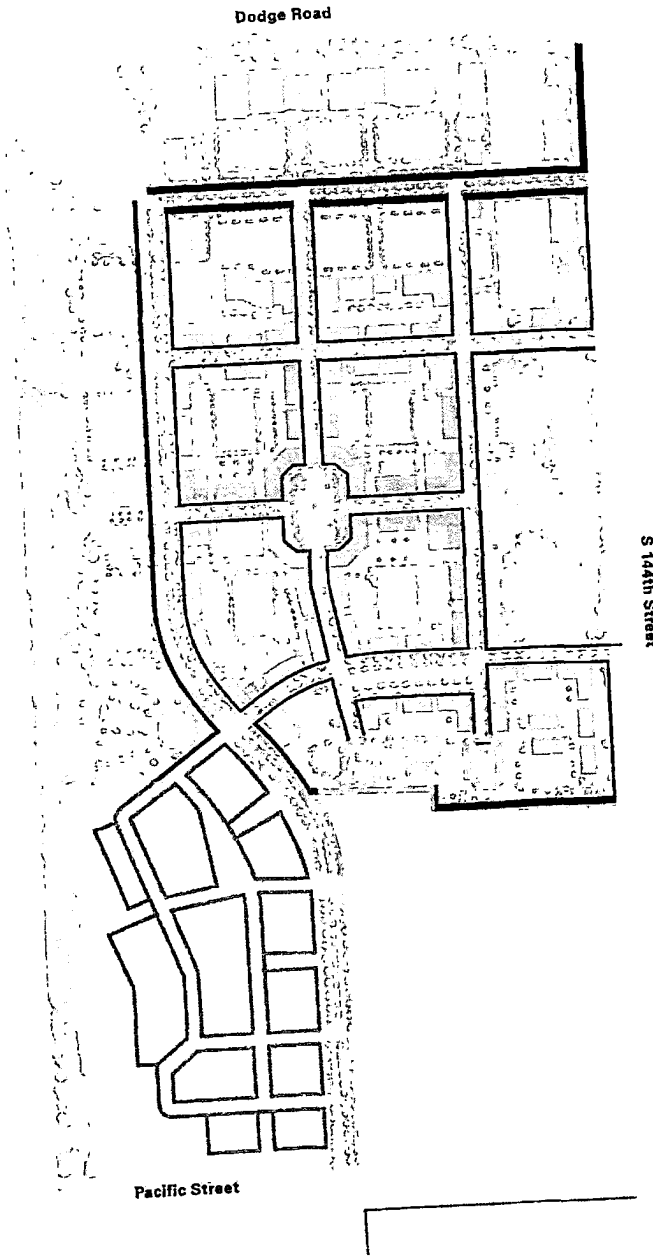



Examples of Residential Setback



Examples of Residential Setback

-  10' SETBACK
-  15' SETBACK
-  20' SETBACK



Setback Diagram

ACCESS AND SERVICE



Example of appropriate screening with fencing



Example of appropriate screening with a structure

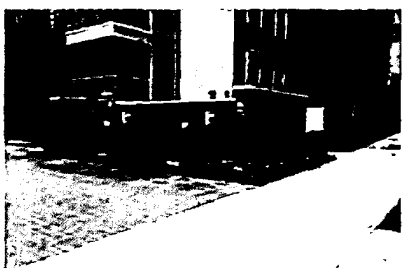

Example of appropriate screening with walls and landscaping



Example of appropriate screening with architectural walls

Service to all buildings should be located at the rear of the building in the middle of the blocks. One curb cut per block is permitted on all streets of less than 350 feet in length for access to service lanes, and two curb cuts for blocks longer than 350 feet.

Loading areas and dumpsters are required to be internal to the block and accessed by service lanes. No service doors shall face onto primary streets or parks. Loading docks, dumpsters, and building equipment should be screened from view with walls and landscaping. The service lanes and mid-block areas will be used for parking and accessible to the general public. These mid-block areas should be as attractive as they can be.

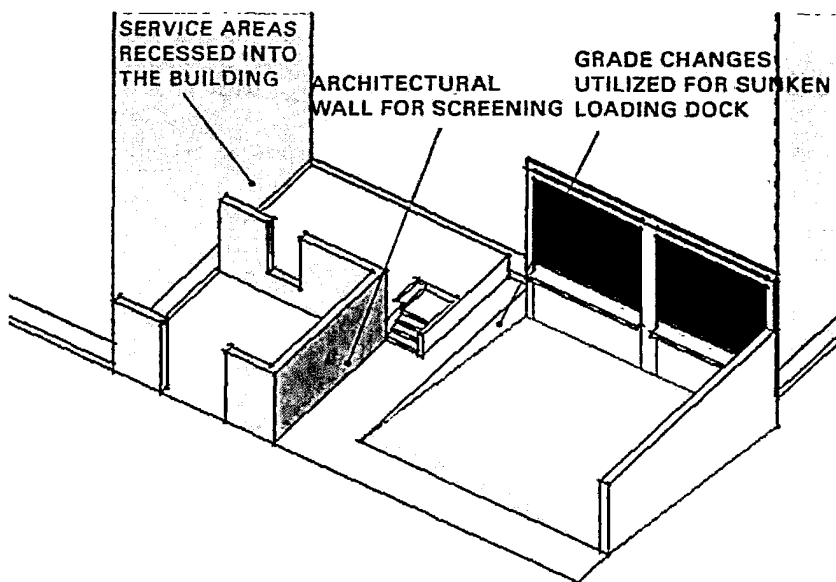

Appropriate service frontage diagram

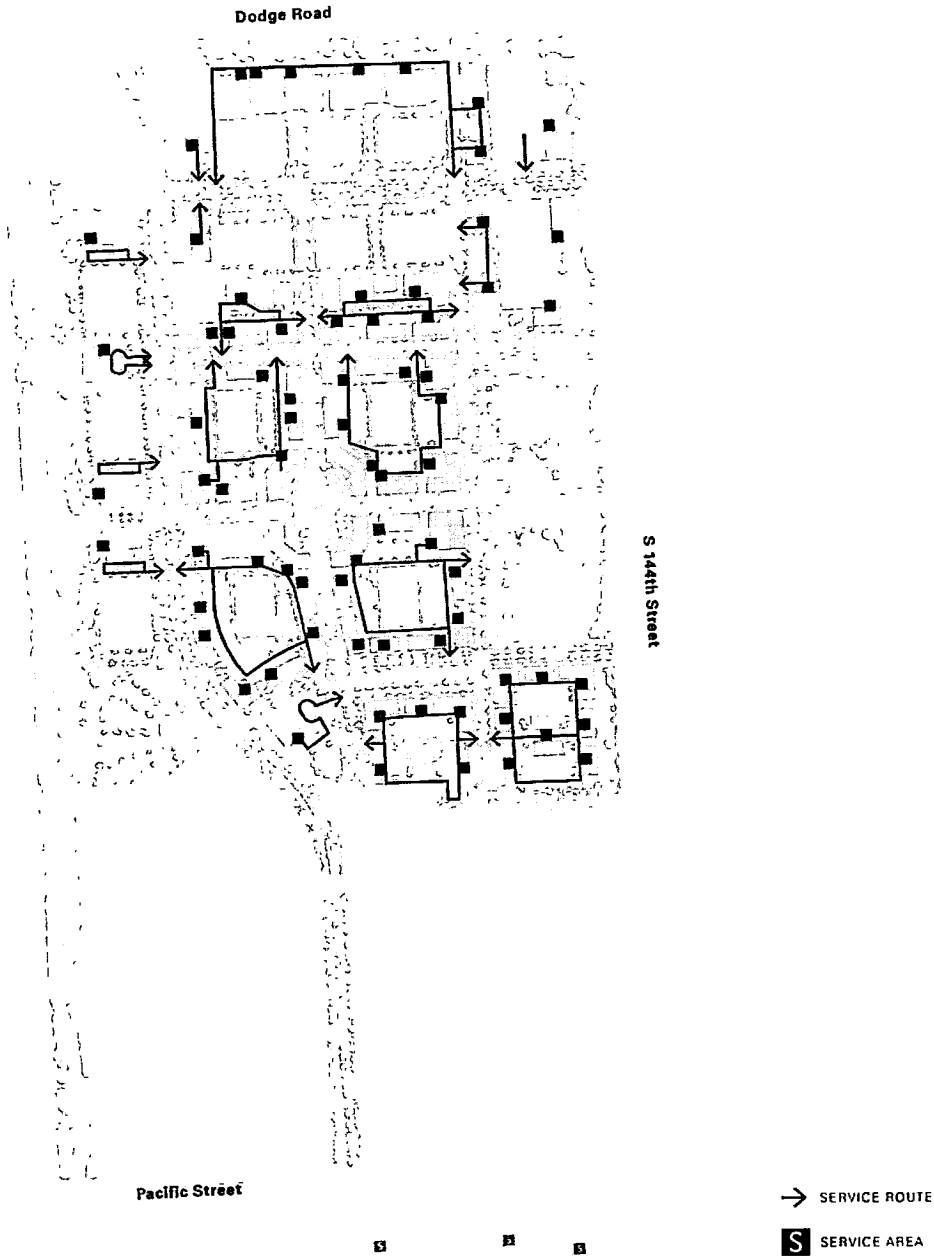

Access and Service Diagram

PARKING

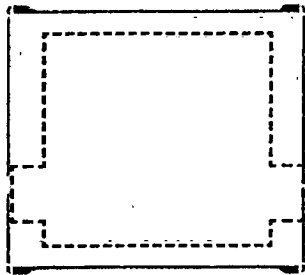

Diagram of required parking setbacks

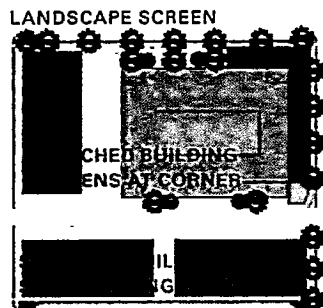
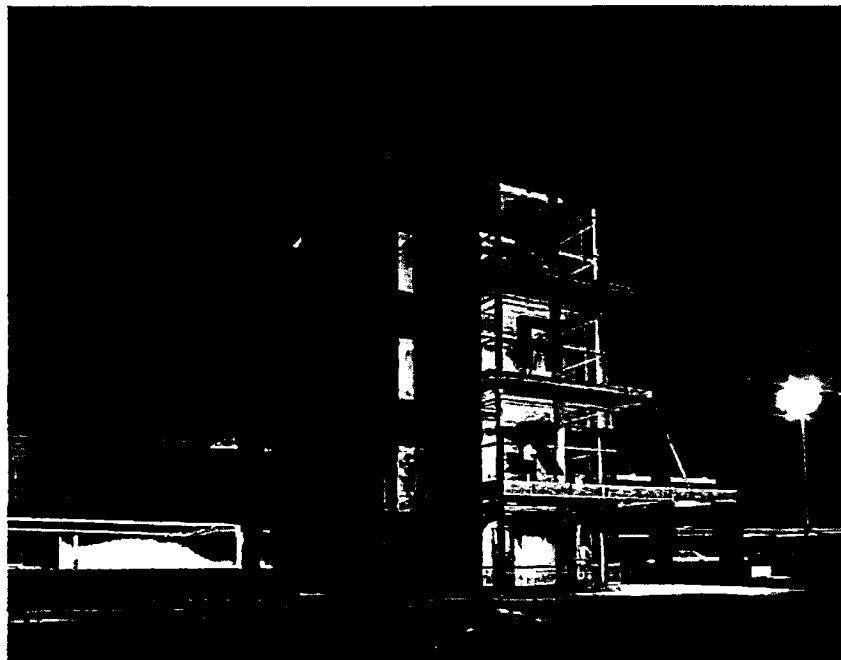

Diagram of design techniques to hide parking

Parking is permitted in the middle of development blocks. The minimum setback for all parking is 10 feet. Parking lots should meet the landscaping standards required by the City of Omaha. Attractive passages and pedestrian connections should be provided between the mid-block parking area and streets. Much of the success of a retail district is the ease and attractiveness of parking and walking to shopping streets.

In some instances, parking garages will be required. Garages may be concealed with free standing street-oriented buildings or attached liner buildings. Access to garages for motorists and pedestrians should be clear and direct. Elevator lobbies should be highly visible and well illuminated at night.

Parking is not permitted inside buildings along street frontages at the ground floor. Street frontages must have active residential and commercial uses. Parking is permitted on the ground floor in the back.



Midblock parking garage with highly visible elevator lobbies and pedestrian entrance

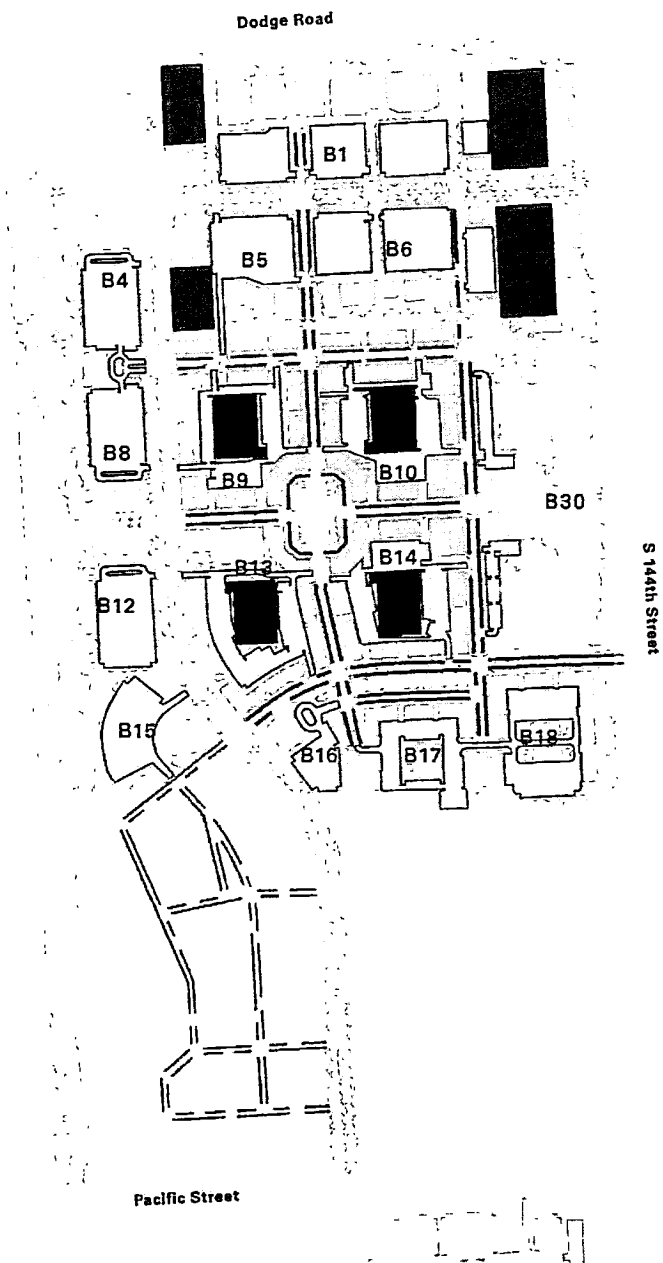

West Farm Mixed Use District

Block	On Street	Surface	Structured
B1	—	724	1,500
B4	—	306	—
B5	46	319	320
B6	72	512	—
B7	—	108	800
B8	—	406	—
B9	50	188	510
B10	50	208	710
B12	—	292	—
B13	69	178	568
B14	64	266	426
B15	—	346	—
B16	19	107	—
B17	41	218	—
B18	14	344	—
B30	22	177	—
Total	447	4,699	4,834

- ON-STREET PARKING
- SURFACE LOT
- SINGLE LEVEL PARKING DECK
- PARKING GARAGE



Parking Location Diagram

BUILDING TYPES



Example of a Mixed-Use Building



Example of a Mixed-Use Street



Example of a Retail Building

Retail, Mixed-use, and Office Buildings

This category includes single-story retail buildings, multi-story buildings with ground floor retail and upper floor offices or residential, and office buildings. In most instances, these buildings will be located fronting a street and will contribute towards making an important public space. These buildings should be lively, attractive, and inviting. They may include storefronts, commercial signage, canopies, awnings, and large windows for transparency and openness. The ground floor facing the street must be occupied space (active uses such as retail and office). Parking is not permitted within 20 feet of the street at the ground floor. Rear "tuck-under" parking is permitted. The ground floor of these buildings is typically 16 to 20 feet in height to accommodate retail uses and commercial lobbies.

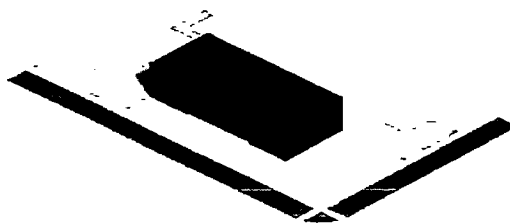

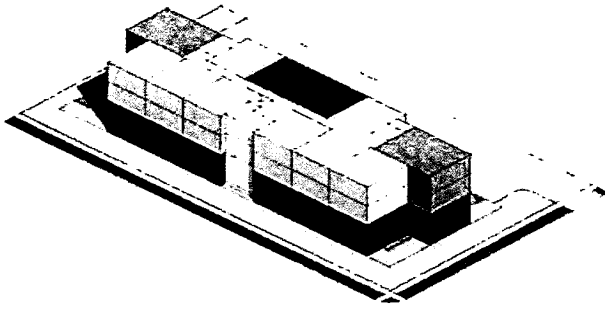

Mixed Use Building Type

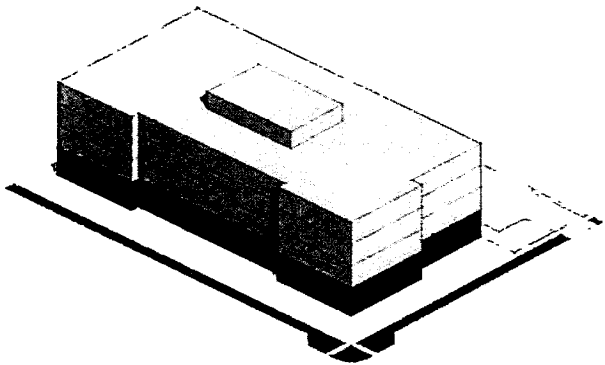

Office over Retail

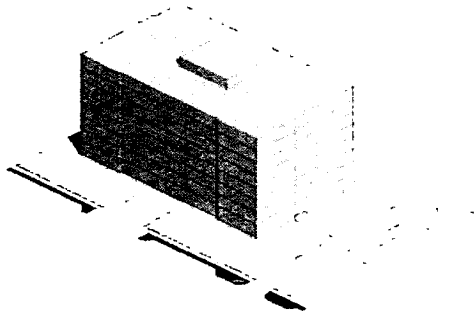

Office

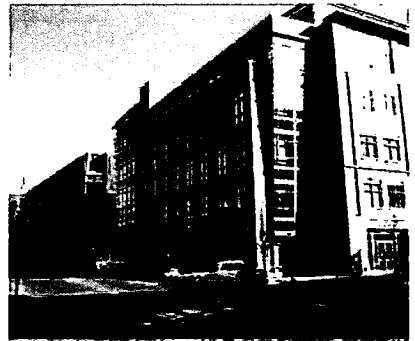

BUILDING TYPES

Multi-Family Housing

Multi-family Housing includes the following building types:

APARTMENT BUILDINGS

Conventional apartment units with corridor access and surface parking mid-block

SOFT LOFT BUILDINGS

Urban loft units with taller floor to floor heights and loft finishes

MAISONETTE BUILDINGS

Multi-unit building with ground floor units accessed from the street with surface and/or tuck under parking

MANSION APARTMENT BUILDINGS

Small apartment buildings that appear like large houses

The ground floor of the multi-family housing facing the street must be residential units or amenities. Parking is not permitted within 20 feet of the street at the ground floor. Rear “tuck-under” parking is permitted. “Podium buildings” with parking filling the whole ground floor and apartments above must comply with design guidelines.

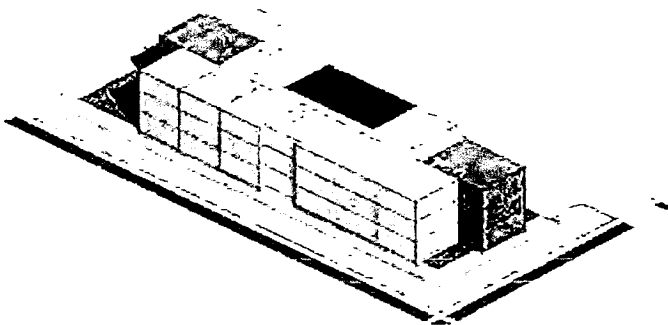

TYPICAL APARTMENT BUILDING

May range from 3–5 stories with 10-foot floor-to-floor heights.



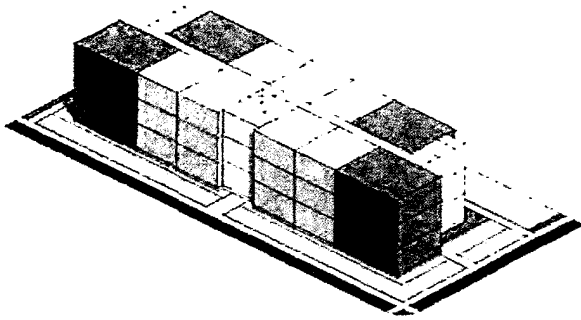

SOFT LOFT BUILDING

*Taller floor to floor heights allow for loft units with mezzanines.
These buildings may range from 2–8 stories.*

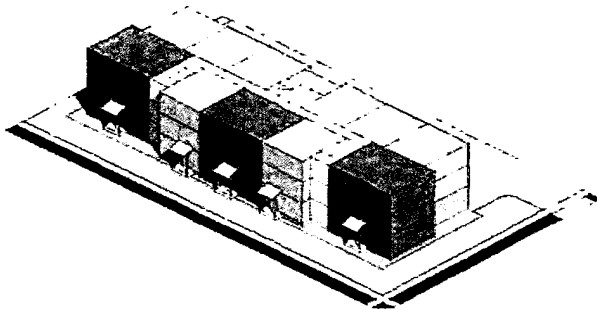
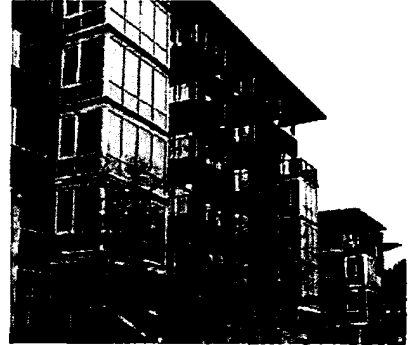

MAISONETTE BUILDING

*Ground floor units are access from stoops on the street.
Tuck-under parking is encouraged in the rear of the ground floor.*

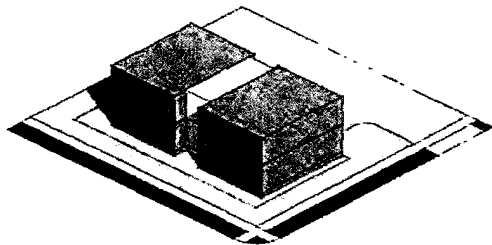

MANSION APARTMENT BUILDING

*4–6 units are accessed from a shared central stair.
These range from 2–3 stories.*



BUILDING TYPES

Attached Housing

Attached houses are two or more single family houses that share a common wall. Three forms of attached housing are included in the master plan.

LINER TOWNHOUSES

These are single family houses backing to a parking structure. Placement of the units helps conceal views of the garage.

CORNER DUPLEX

Two townhouses are attached and located on a corner to resemble a large house with a main body and attached wing. Each unit has a separate entrance and porch. These are attractive on corners because each street has a facing house at the intersection.

MODIFIED TOWNHOUSES

These buildings consist of individual houses attached with single story garage structures. They look like separate houses from the street even though they are joined. These units are great for shallow lots where there is not enough backyard space for parking and outdoor activities.

TOWNHOUSES

These are single-family houses of two or three stories in height that share common walls. They come in many different widths and plan configurations.

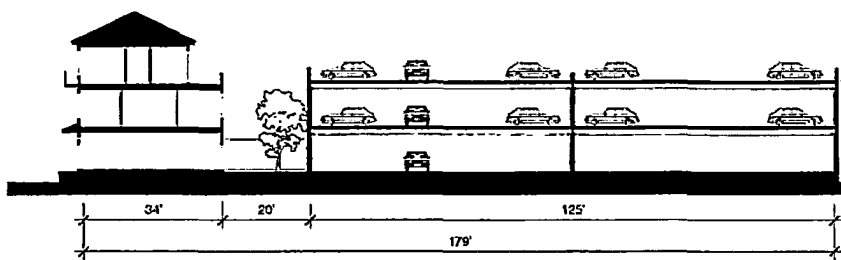

LINER TOWNHOUSES
Single-family houses backing to a parking structure

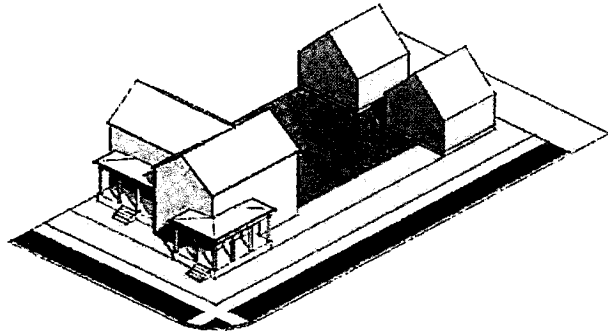

CORNER DUPLEX
Articulated as a large house with two fronts, making it ideal for corner lots

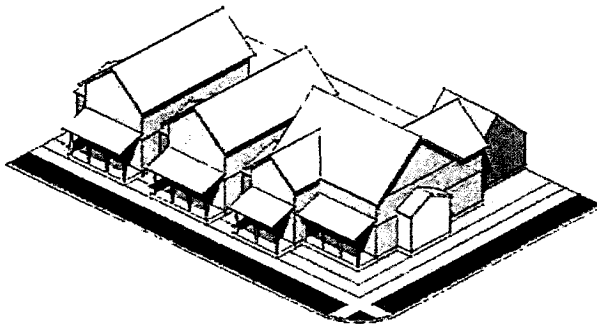

MODIFIED TOWNHOUSE
Townhouses are connected by single bay garages. These work well on shallower lots.

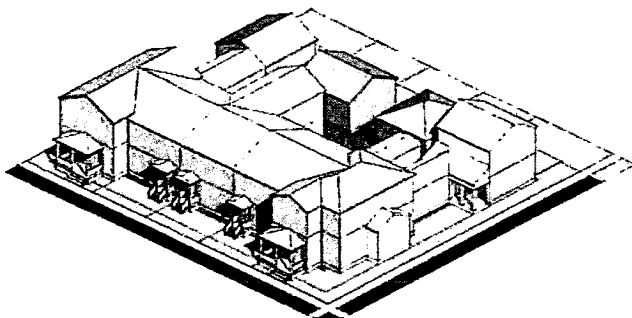

TOWNHOUSE/ROWHOUSE
This versatile building type creates a continuous street facade. They can be parked in a court, detached garages, or tuck-under parking in the rear of the house.

BUILDING TYPES IN PLAN

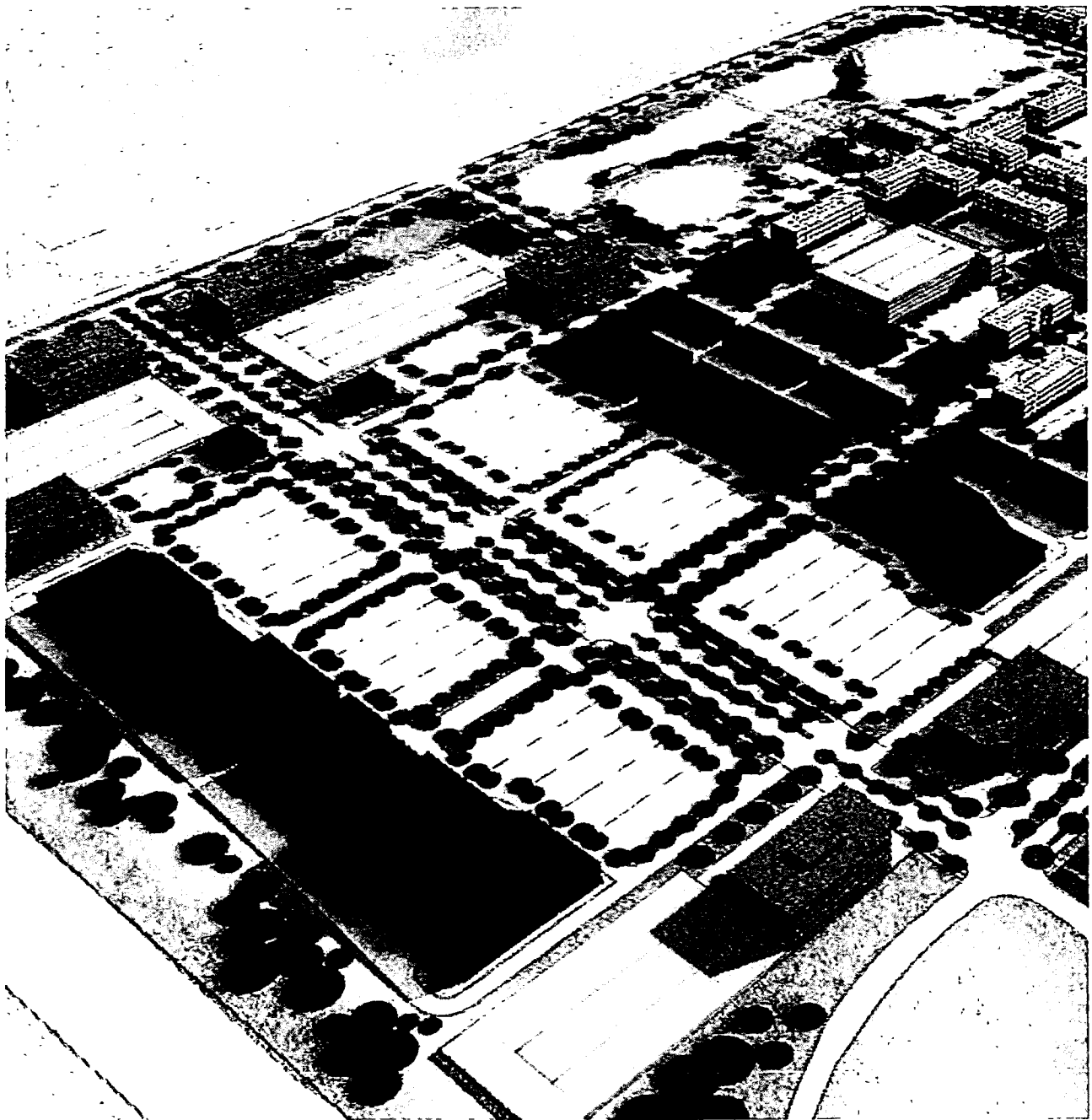

View of West Farm Mixed-Use District looking Southeast

DRAFT | 01 MAR 2017

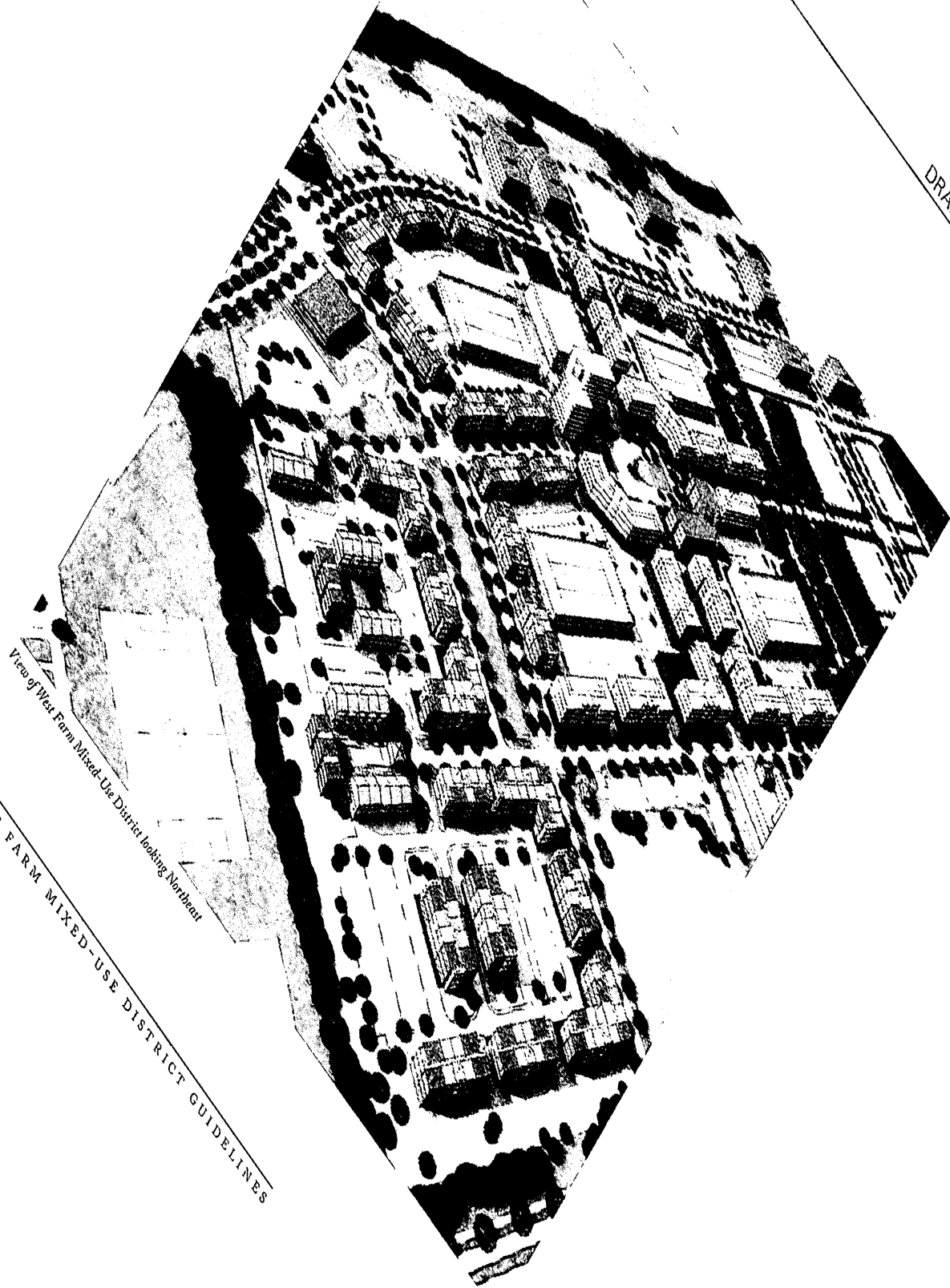

View of West Farm Mixed-Use District looking Northeast

WEST FARM MIXED-USE DISTRICT GUIDELINES





OMAHA, NEBRASKA | JUNE 23, 2017

West Farm/South Farm Design Guidelines

Prepared by URBAN DESIGN ASSOCIATES

West Farm/ South Farm Design Guidelines

PREPARED FOR

New West Farm Holdings LLC

South Farm Holdings LLC

CONSULTANT TEAM

Urban Design Associates

HDR, Inc.

HR&A Advisors

Lamp Rynearson & Associates, Inc.

TABLE OF CONTENTS

INTRODUCTION

The Plan	2
----------	---

ARCHITECTURAL PATTERNS

INTRODUCTION	6
Building Principles	6
SUSTAINABILITY	8
Green Development Principles	8
BUILDING TYPES	10
DETACHED HOUSING	14
Overview	14
Architectural Styles	15
Massing and Composition	16
Assembly Kit	17
ATTACHED HOUSING	18
Overview	18
Unit Massing and Composition	19
Building Composition	20
Assembly Kit	21
MULTI-FAMILY RESIDENTIAL BUILDINGS	22
Overview	22
Basic Structure and Articulation	23
Facade Composition	24
Assembly Kit	25
MIXED USES BUILDINGS	26
Overview	26
Basic Structure and Articulation	27
Facade Composition	28
Assembly Kit	29

OFFICE BUILDINGS	30
Overview	30
Basic Structure and Articulation	31
Facade Composition	32
Assembly Kit	33
FREE-STANDING BUILDINGS	34
Overview	34
Basic Structure and Articulation	35
Facade Composition	36
Assembly Kit	37
LARGE RETAIL BUILDINGS	38
Overview	38
Basic Structure and Articulation	39
Facade Composition	40
Assembly Kit	41
STRUCTURED PARKING	42
Overview	42
Freestanding	43
Podium	44
2-Deck Platform	45
ASSEMBLY KIT	
OVERVIEW	48
1. BAY ARTICULATION	50
1a. Architectural Bays	50
1b. Bay Design Principles	51
2. DOORS AND WINDOWS	52
2a. Punched Openings	52
2b. Continuous Assemblies	53
3. ROOF FORMS	54
3a. Sloped Roofs	54
3b. Flat Roofs	55

TABLE OF CONTENTS

4. ENTRANCES	56
4a. Residential	56
4b. Storefronts	57
5. WINDOW BAYS AND BALCONIES	58
5a. Projecting Bays	58
5b. Balconies	59
6. ADDITIONAL ELEMENTS	60
7. MATERIALS	62

SIGNAGE GUIDELINES

OVERVIEW	66
Objectives	67
COMMUNITY ART	70
SIGN TYPES	72

LANDSCAPE PATTERNS

BACKGROUND	78
Public Open Space Plan	78
OVERVIEW	80
Landscape Patterns for Private Development	80
MIXED-USE DISTRICT LANDSCAPES	82
West Farm Mixed-Use District	83
West Farm Large Retail Area	84
South Farm Mixed-Use District	85
RESIDENTIAL DISTRICT LANDSCAPES	86
West Farm South	87
South Farm West	88
South Farm East	89



BUILDINGS AND LOTS GUIDELINES	90
Landscape Zones	90
Front Yard Elements	92
Side-Street and Rear Yard Elements	94
Paving and Terrace Materials	96
Fencing, Walls, and Plant Borders	98
Parking Area Landscape Elements	100
Sustainability Elements	102
Plant Palette	104

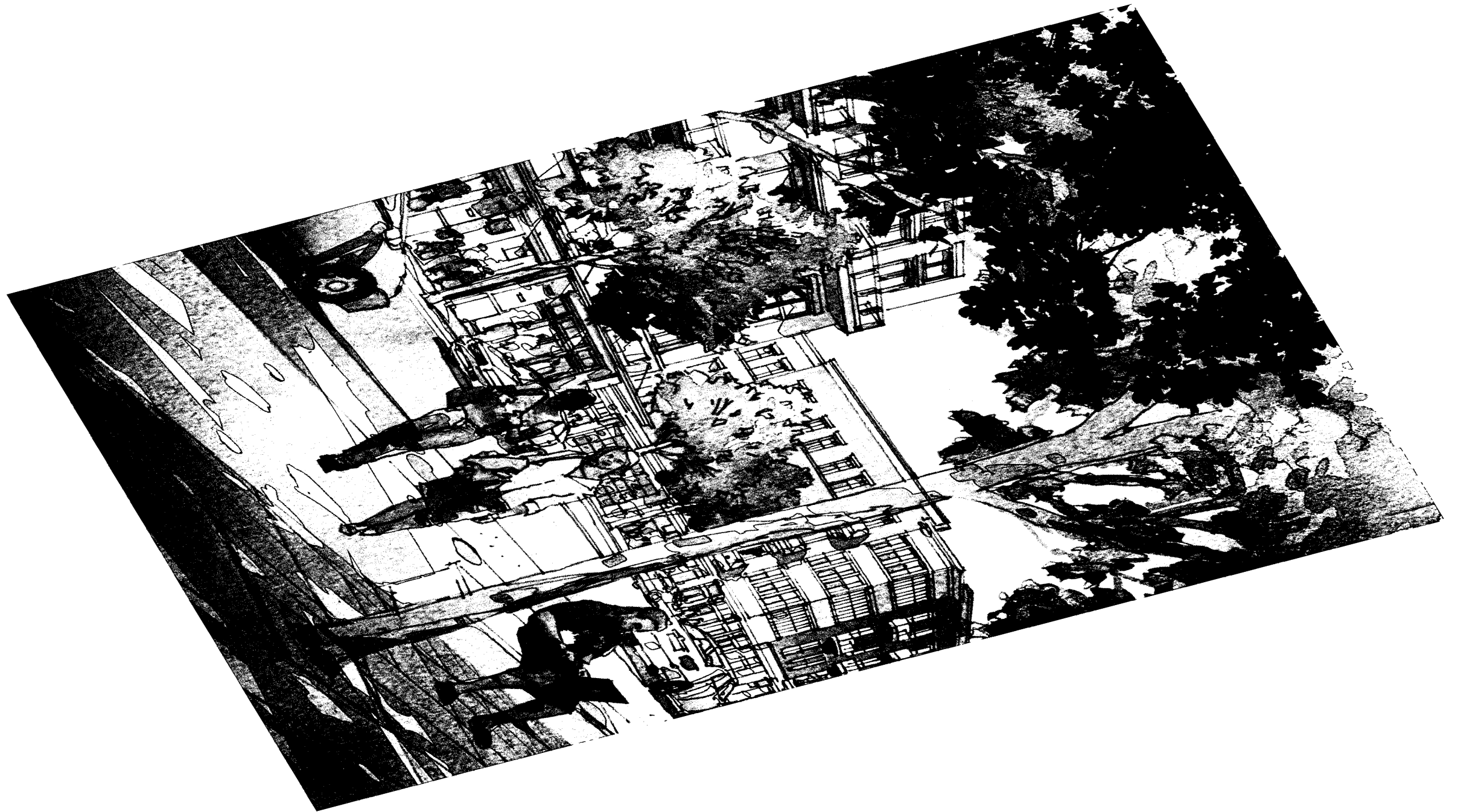

INTRODUCTION

OVERVIEW

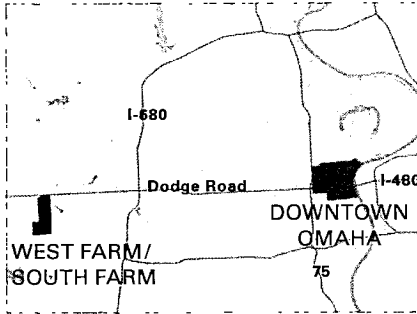

Location Plan

The Plan

The West Farm/South Farm Development is a new mixed-use community located on farmland once owned and operated by the historic Boys Town Village and the DeMarco family. This new development is strategically located in the major growth area of western Omaha between West Dodge Road and Pacific Street at the corner of 144th Street.

- » West Farm, the northern part of the development formerly owned by Boys Town, will include a mixed-use town center with shops and restaurants, a retail center, an office park, urban apartment living, and a major new central park and trail system.
- » South Farm, formerly owned by the DeMarco family, will include a new corporate campus for Applied Underwriters, a mixed-use village with neighborhood retail and residential, and an exclusive large lot residential community, all connected by an open space network of rolling hills and trails.
- » In total, the development will include over 1,400,000 square feet of office space, 819,000 square feet of retail, a 300-room hotel, 1,600 apartments, 144 townhouses, and 290 single-family houses. One-third of the total land area will be devoted to parks, trails, and recreation areas.



A mix of uses, including office, residential, and retail, activates the streets



Neighborhood parks act as gathering places and for recreation



A Village Square serves as the heart of the community

Illustrative plan



INTRODUCTION

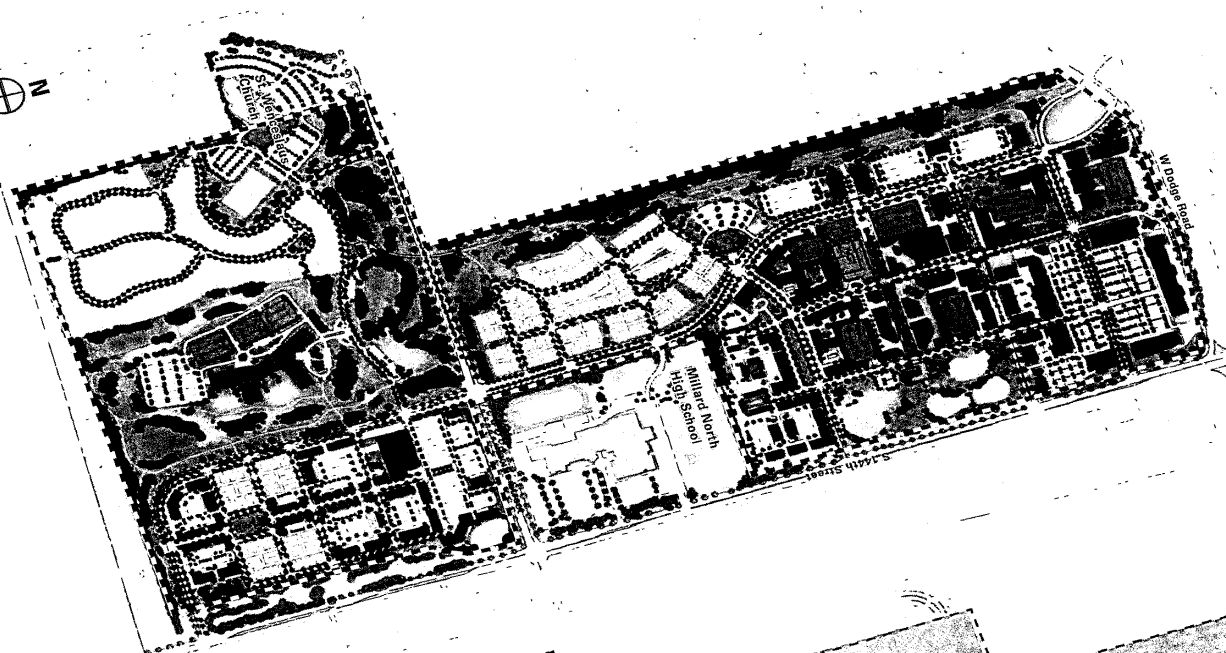

- SITE BOUNDARY
- OFFICE
- MIXED USE
- RETAIL
- HOTEL
- MULTI-FAMILY RESIDENTIAL
- SINGLE-FAMILY RESIDENTIAL
- INSTITUTIONAL
- PLATFORM PARKING
- STRUCTURED PARKING

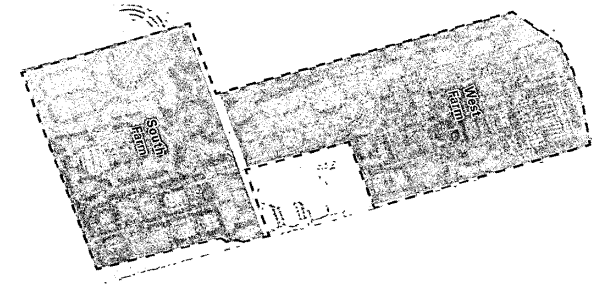





ARCHITECTURAL PATTERNS

INTRODUCTION

Building Principles

Great urban centers are the product of incremental development that collectively creates a diverse and memorable neighborhood fabric. Value increases with every year that passes as new investments are made. While individual buildings may differ dramatically in design and size, great districts are achieved by following basic principles that create a shared urban realm. Across all building types, these principles ensure that each parcel and building contributes to the sense of place and urban character. These principles include:

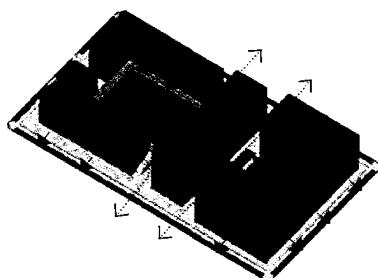

1. Use buildings to frame public realms

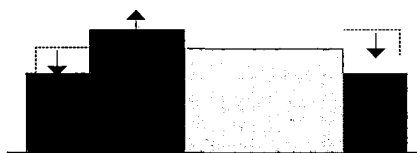

2. Break down building massing

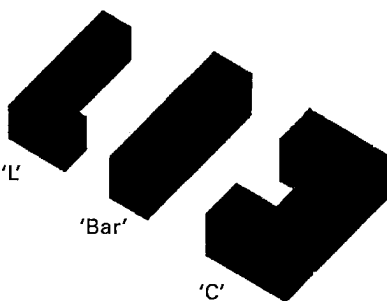

3. Use legible building forms

1. USE BUILDINGS TO FRAME THE PUBLIC REALM AND CREATE SEMI-PRIVATE SPACES

Buildings should have clear frontages along streets and open spaces with prominent use of doorways, building entrances, storefronts, and windows. Buildings also may be used to create semi-private spaces off the street including urban spaces such as courtyards, passageways, and mews.

2. BREAK DOWN BUILDING MASSING TO CREATE A DIVERSE AND HUMAN-SCALED CITYSCAPE

Modulating the building mass creates a more interesting skyline, preserves views, provides intimate roof spaces, and improves the extension of light and air down to street level. Building massing may be used to highlight prominent corners, terminate views down streets, and create an urban “room” around park spaces.

3. USE SIMPLE, LEGIBLE BUILDING FORMS TO CREATE NEIGHBORHOOD FABRIC

In most successful urban districts, there is a base of “fabric” buildings. These simple urban building forms utilize main body geometries such as an ‘L’ shape, bar, or ‘C’ shape. Diversity is created through different combinations and positioning of these forms along a street. These “fabric” buildings establish distinct 1- to 12-story street walls and provide a background landscape that frames more prominent landmark buildings at pivotal sites or gateways.

4. USE VERTICAL AND HORIZONTAL BUILDING ELEMENTS

Urban buildings respond to their context using a variety of vertical and horizontal planes and forms. Vertical elements, such as towers or multi-story glazing may be used on prominent corners or to punctuate views. Horizontal features such as arcades, bands, or material shifts close to the ground floor or building base help to reinforce the human scale of the urban streetscape.

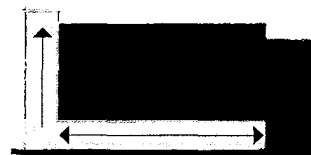

4. Use vertical and horizontal building elements

5. ESTABLISH ARCHITECTURAL BAY RHYTHM

Structural bays are used to organize a building facade or to create multiple facades along a block face. Bays are typically 6 to 16 feet wide. A change in facade may entail any combination of the following: a plane shift of more than 2 feet; a change in material, color, or bay width; different detailing; and/or a minimum of a half-story height change. The same facade for building types other than attached housing should not repeat itself more than two times along a block face or be used twice in a row.

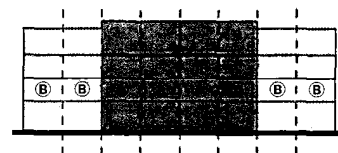

5. Establish bay rhythm

6. EMPLOY A CLEAR "KIT-OF-PARTS"

As buildings have evolved, a number of elements have been developed to make buildings more functional, memorable, environmentally responsive, and architecturally sound. Together, these elements form a "kit-of-parts" that is translated into a building's architectural language. These elements include standard and special window types, storefronts, projecting bays, balconies, roof forms, shade screens, material assemblies, vertical circulation, roof terraces, and penthouse components.

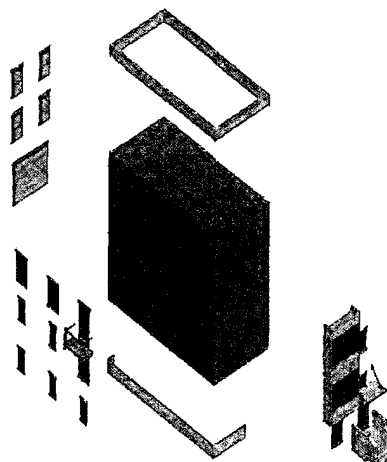

6. Employ a clear "Kit-of-parts"

SUSTAINABILITY

Green Development Principles

Sustainable development celebrates the connection between the built and natural environment; minimizes the impact of design, construction, and operation on natural resources; and creates healthy and comfortable building environments. Architects and developers can contribute to resource conservation and community health by using strategies for sustainable architecture and design in West Farm / South Farm.

These *West Farm / South Farm Design Guidelines* recommend that buildings seek certification through a standard such as LEED® or an approved equivalent. Considerations for sustainable development include:

- » Solar and wind orientation
- » Pedestrian circulation and access, bicycle use, and alternative transportation
- » Reuse of stormwater and innovative water use reductions
- » On-site renewable energy and green power solutions
- » High-efficiency mechanical systems
- » Enhanced refrigerant management for air-conditioning systems
- » Reused and recycled materials
- » Improved indoor environmental quality including: daylighting, views, thermal comfort, operable windows, and low chemical-emitting materials

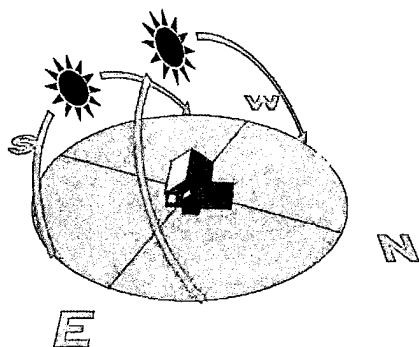

Orient primary living spaces and windows to face south, providing passive solar energy to warm the building in the cool months when the sun is lower in the sky.



Solar panels provide renewable energy



Operable windows improve indoor environmental quality

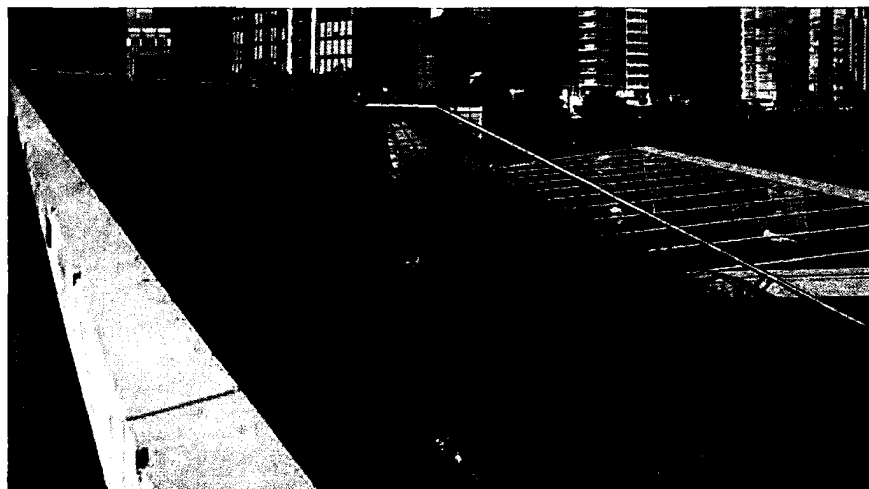

Green roofs are a valuable user amenity. Additionally, they provide added insulation and improve air quality.



ESSENTIAL ELEMENTS

A. ROOFS

Utilize rooftop renewable power generation and stormwater management to reduce reliance on utilities and infrastructure. Green roofs provide a valuable user amenity, improve the durability of roofing membranes by protecting them from the elements, and increase the insulating value of the roofing system.

B. BALCONIES & SHADE DEVICES

Utilize architectural devices and plants to shade the building and interior spaces from the sun. This decreases energy use and provides a more comfortable living environment.

C. WINDOWS

Utilize operable windows for natural ventilation, and improved indoor air quality.

D. ENTRIES

Provide easy pedestrian access to public ways to encourage pedestrian circulation and alternative means of transportation.

BUILDING TYPES

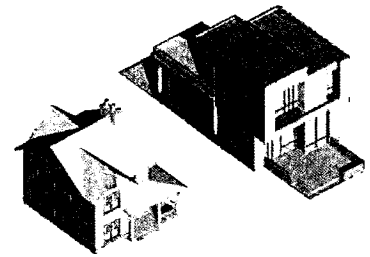





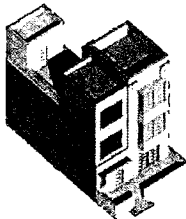
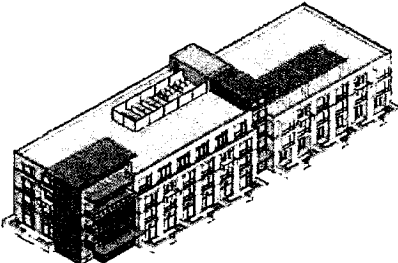
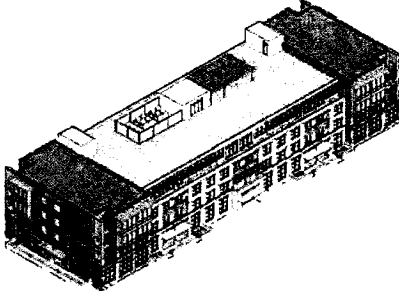

DETACHED HOUSING

Height: 1-3 Stories



Locations in the Plan: West Farm
South, South Farm West, South
Farm East

 <p>ATTACHED HOUSING</p>	 <p>RESIDENTIAL BUILDINGS</p>	 <p>MIXED USE BUILDINGS</p>
<p>Height: 2–3 Stories</p>	<p>Height: 3–5 Stories</p>	<p>Height: 3–5 Stories</p>
		
		
<p>Locations in the Plan: South Farm East, West Farm Mixed-Use, South Farm Mixed-Use</p>	<p>Locations in the Plan: South Farm East, West Farm Mixed-Use</p>	<p>Locations in the Plan: West Farm Mixed-Use and South Farm Mixed-Use</p>

BUILDING TYPES

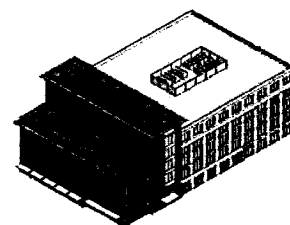

OFFICE BUILDING

Height: 4–6 Stories

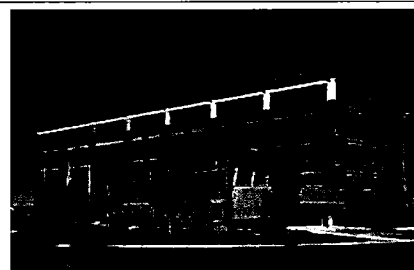

Locations in the Plan: West Farm
Mixed-Use and South Farm Mixed-
Use

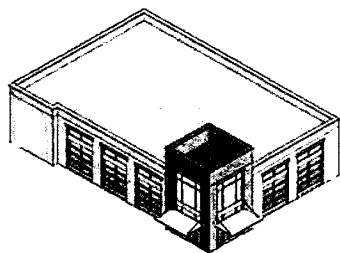

FREE-STANDING BUILDINGS

Height: 1-2 Story



Locations in the Plan: West Farm Mixed-Use and South Farm Mixed-Use

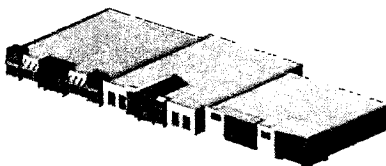

LARGE RETAIL

Height: 1-1½ Stories

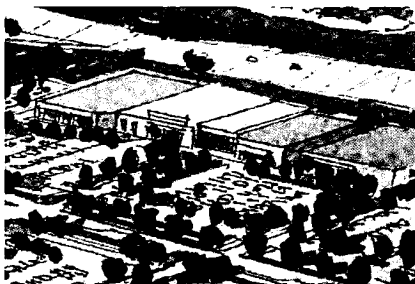

Locations in the Plan: West Farm Mixed-Use and South Farm Mixed-Use

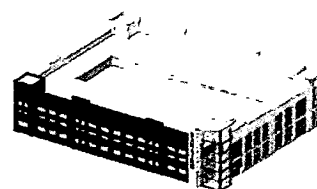

STRUCTURED PARKING

Height: 2-6 Stories



Locations in the Plan: West Farm Mixed-Use and South Farm Mixed-Use

DETACHED HOUSING

Overview

GUIDING PRINCIPLES

- » Select an approved architectural style.
- » Provide a simple main body massing with additive wings or secondary masses emphasized as special architectural features.
- » Articulate facades with balanced compositions of windows and doors.
- » Finalize the assembly with stylistically appropriate architectural elements from the Assembly Kit

Detached housing is 1 to 3 stories in height and relatively small in scale. West Farm/South Farm houses will draw on architectural languages that have unique regional character appropriate to the site. Traditional styles such as Arts & Crafts, English Romantic, Colonial as well as Contemporary styles can be found in many of the surrounding neighborhoods throughout the city. Every region has unique attributes that shape the character of the place. This mix in particular makes up a highly-identifiable language for West Farm/South Farm.





Architectural Styles

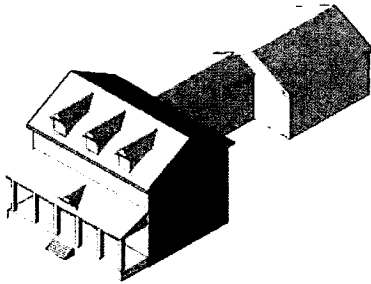

COLONIAL

- » Orderly, symmetrical compositions of doors and windows
- » Simplified versions of classical details
- » Wide multi-pane windows with six-pane patterns, sometimes paired

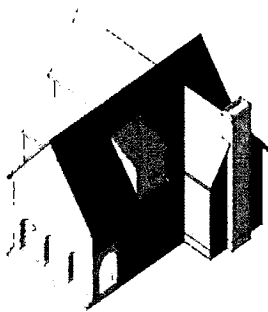

ENGLISH ROMANTIC

- » Steeply pitched roofs with tight eaves and varying eave heights
- » Porches are often subtractive and within the building mass
- » Picturesque massing and compositions

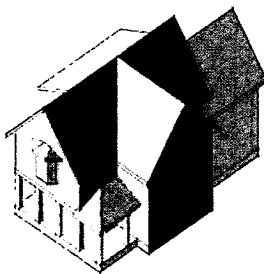

ARTS & CRAFTS

- » Shallow pitched roofs with deep overhangs
- » Deep, broad porches and expressive structural elements
- » A mix of materials such as brick, shingles, and siding
- » Grouped windows

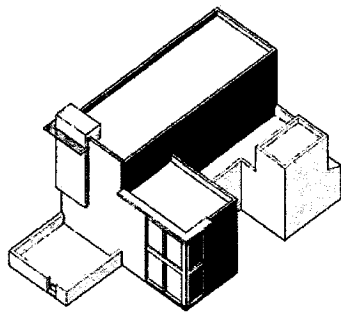

CONTEMPORARY

- » Asymmetrical facade compositions
- » Horizontal roof planes
- » Indoor/outdoor connections
- » Large glazed openings, corner windows where appropriate
- » Overall massing articulated into at least two secondary elements

DETACHED HOUSING

Massing and Composition

BUILDING MASS

- » Building height is 1 to 3 stories. The first floor is typically taller than the upper floors.
- » Diversity may be achieved by adding or subtracting mass from the basic form.



BAY DIVISION

- » Divide the main body into a series of bays. All bays must be vertical in proportion.
- » Architectural elements will be organized within the bay system.



ROOF AND SECONDARY MASS

- » Articulate the roof form with a stylistically appropriate eave or parapet condition.
- » Traditional homes often have additive wings at the side or rear. Contemporary homes often have one bay emphasized as a primary architectural element.

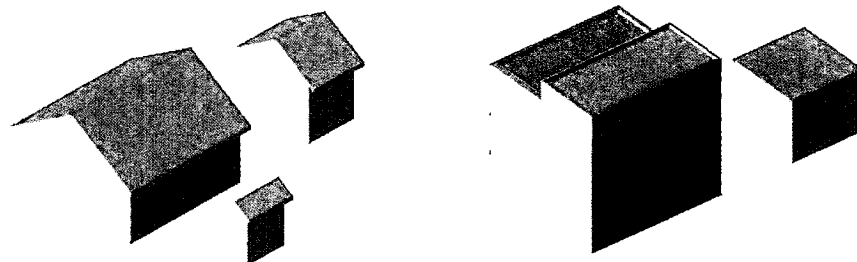

ARTICULATION

- » Articulate the mass with a balanced composition of windows and doors.
- » Architectural styles have associated composition patterns and opening proportions.

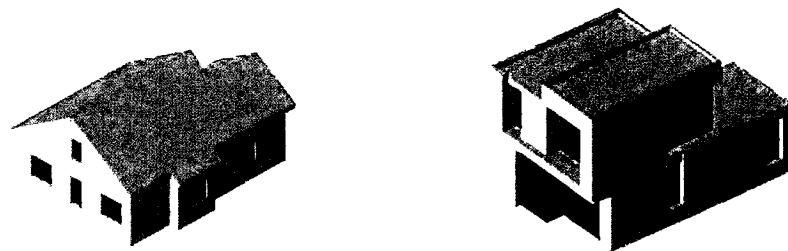

FINAL ASSEMBLY

- » Provide additional Assembly Kit elements and materials in keeping with the architectural style of the home.

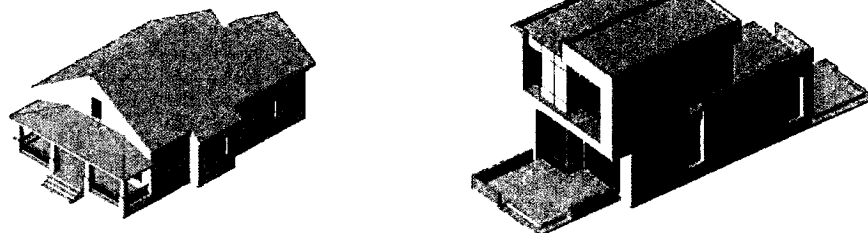



Assembly Kit

Each house is distinguished by a main body massing that is always the most important form. Additional space and articulation is created through secondary additions to this Main Body from the Assembly Kit. The appropriate elements that can be added to detached housing are demonstrated below.

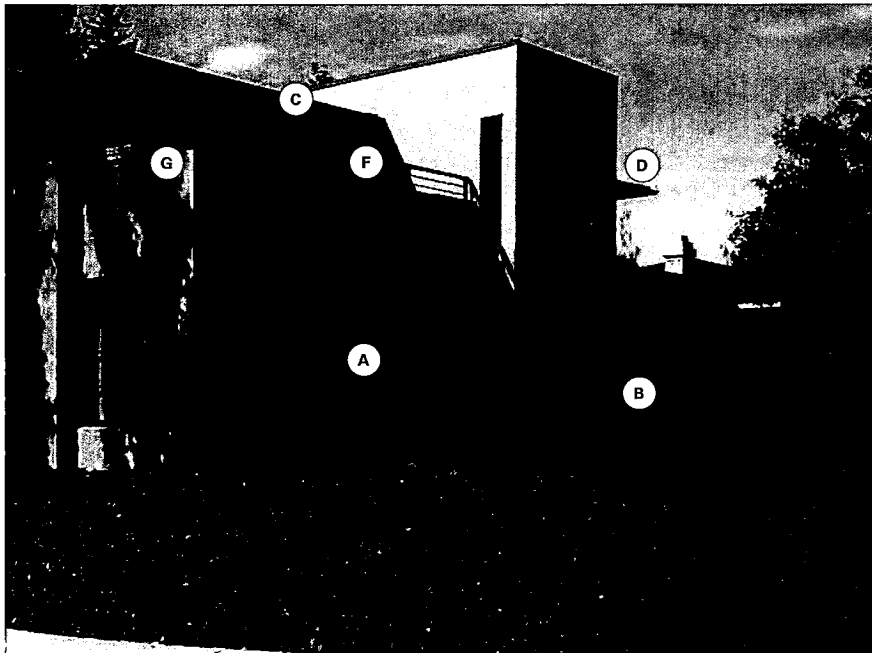

APPROVED ASSEMBLY KIT

Reference the following sections in the Assembly Kit.

A. WINDOWS

Refer to Section 2

B. ENTRANCE AND PORCH

Doors: Refer to Section 2a
Entrance Elements: Refer to Section 4a

C. ROOF FORM

Refer to Section 3

D. SHADING DEVICES

Refer to Section 6a

E. WINDOW BAYS AND BALCONIES

Refer to Section 5

F. ROOF TERRACES

Refer to Section 3b

G. MATERIALS

Refer to Section 7

ATTACHED HOUSING

GUIDING PRINCIPLES

- » Create a town 'fabric.' Each building should fit seamlessly within the context.
- » At the same time, provide a sense of individuality with unit design.

Overview

Attached housing facades are 1 to 3 stories in height and are relatively small in scale. Traditionally, this type of street facade consisted of a collection of individual buildings. Therefore, at intervals of 25 to 50 feet there is either a change of plane, material, architectural style, window pattern, or height. Articulate the basic main body massing of each unit with thoughtful compositions of additive elements at a domestic scale.





Unit Massing and Composition

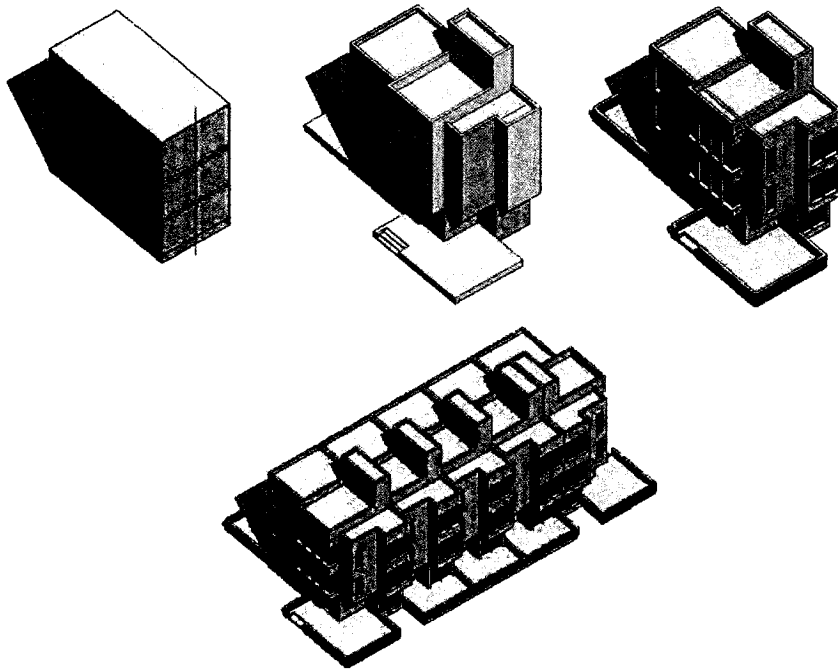

MASSING STRATEGY

- » Building Mass: Height is 1 to 3 stories. First floor is taller than upper floors.
- » Bay Division: Determine a bay structure.
- » Roof and Secondary Mass: Articulate the roof form, add wings, or extrude tower elements.
- » Articulation: Provide a balanced composition of windows and doors. (See details below.)
- » Final Assembly: Add character with Assembly Kit elements. Compose a series of units into a building.

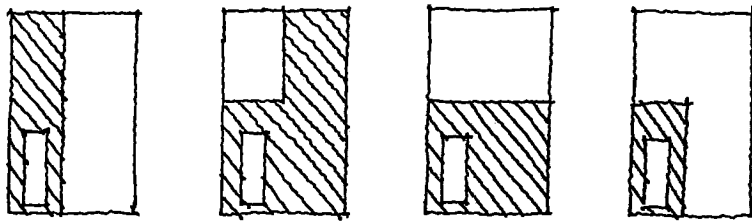

Approved composition diagrams with areas of emphasis hatched

COMPOSITION STRATEGY

- » Start with a simple main body primary mass.
- » Each unit shall have a 'gift to the street' of a balcony, bay window, terrace, and/or porch.
- » Secondary massing elements may contrast with the main body through color and/or material.
- » Center focus at the front door.
- » Consider alignment with adjacent units. Similar facades should be flush at the front elevation. Alternative designs should be offset.



Townhouse elevations that correspond to the approved unit composition diagrams above

ATTACHED HOUSING

Building Composition

GUIDING PRINCIPLES

- » Create groupings of units in complementary colors and materials.
- » Housing may be designed as composed buildings or as a series of individual facades comprised of 2 to 5 units grouped together.
- » The appearance of an individual facade within a building must not exceed 5 units.
- » Additional compositions of complementary units, in keeping with the examples shown, may be proposed.

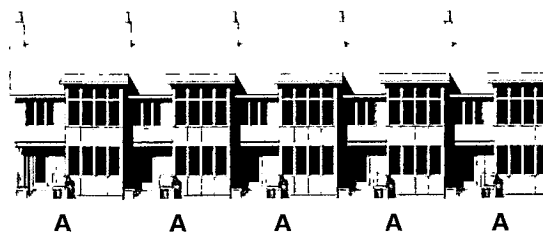
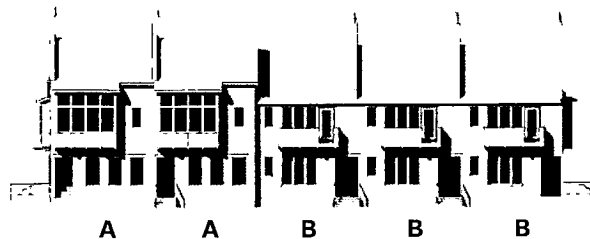
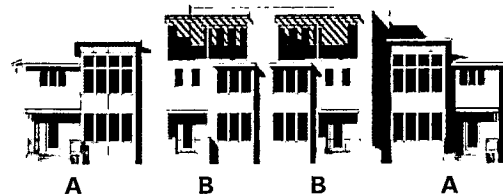
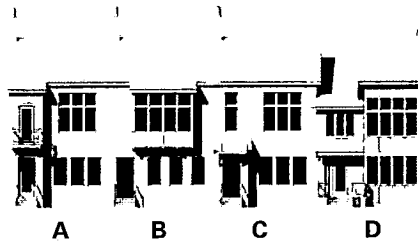

Approved Compositions



Example of building composition



Assembly Kit

Each unit is distinguished by a main body massing that is always the most important form. Additional space and articulation is created through secondary additions to this Main Body from the Assembly Kit. The appropriate elements that can be added to attached housing are demonstrated below.



APPROVED ASSEMBLY KIT

Reference the following sections in the Assembly Kit.

A. WINDOWS

Refer to Section 2

B. ENTRANCE

Doors: Refer to Section 2a
Entrance Elements: Refer to Section 4a

C. ROOF FORM

Refer to Section 3

D. SHADING DEVICES

Refer to Section 6a

E. WINDOW BAYS AND BALCONIES

Refer to Section 5

F. ROOF TERRACES

Refer to Section 3b

G. MATERIALS

Refer to Section 7

MULTI-FAMILY RESIDENTIAL BUILDINGS

Overview

GUIDING PRINCIPLES

- » Compose long facades into a series of buildings that reinforce a human scale and create a varied, attractive skyline.
- » Highlight the building base and entry to increase the richness of the pedestrian experience.
- » Detail the building top to add interest to the building's skyline.
- » Compose facades with a combination of horizontal emphasis to establish a pedestrian scale and vertical emphasis for landmark elements and an enhanced skyline.
- » Avoid monotonous repetition of elements without changes to placement and/or detailing.

Mid-rise residential buildings are 3 to 5 stories in height and larger in scale. Buildings should be articulated to reinforce a pedestrian scale. Therefore, at intervals of 50 to 125 feet there should be either a change of plane, material, architectural style, window pattern, or height. There is a one- or two-story base, a middle area of several stories, and a top which can be either one or two stories in height. Ground-floor facades of residential buildings have facades with residential entrances, windows, or common lobby entrances. The fenestration patterns on the upper floors of residential buildings should have domestically-scaled windows.





Basic Structure and Articulation

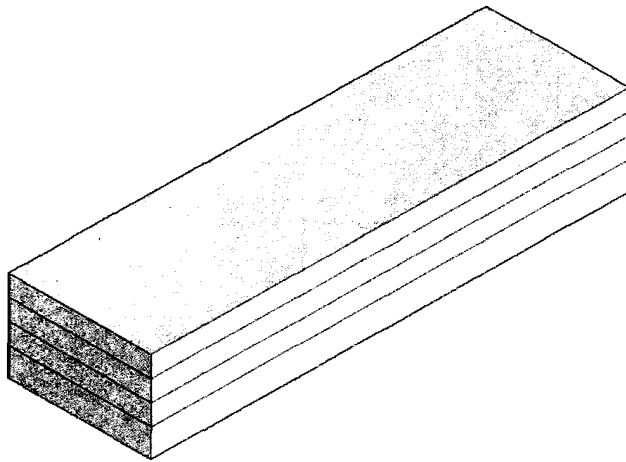

MASSING AND HEIGHT

Basic building mass should be 3 to 5 stories. Articulate the building with facade divisions that range from 50 to 125 feet in width.

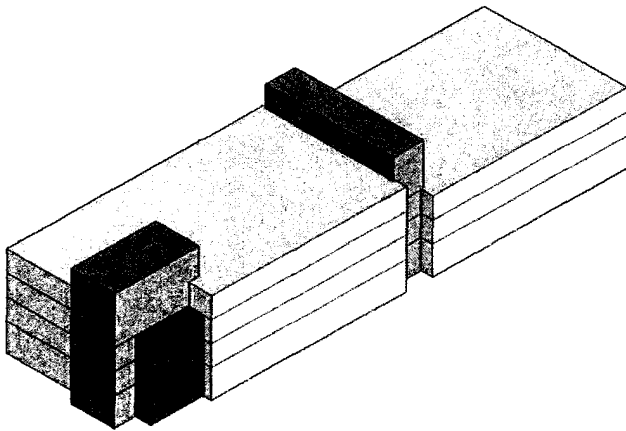

VERTICAL ARTICULATION

All facades over 65 feet wide must be further subdivided. Distinguish these divisions by changes in material, color, plane, architectural detailing, height, fenestration types, or facade composition.

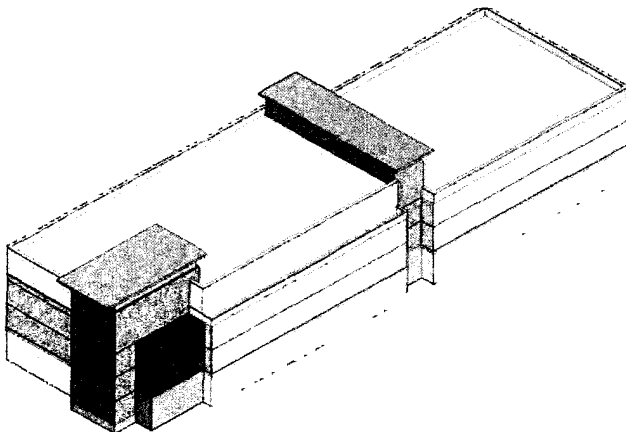

HORIZONTAL ARTICULATION

Horizontal articulation may define a base, middle, and top for each articulated facade. This can be accomplished with window composition, materials, or special features. Buildings over 3 stories must have an expressed base.

MULTI-FAMILY RESIDENTIAL BUILDINGS

Facade Composition

FENESTRATION

Ground floors should be articulated with larger residential window patterns that differentiate it from the massing above. Emphasize building entries with architectural elements that can be clearly identified from the pedestrian realm. The maximum bay width at stories above the ground floor level should be 16 feet. Provide vertically proportioned windows in a wide variety of types including groups of tall windows to maximize glass area.

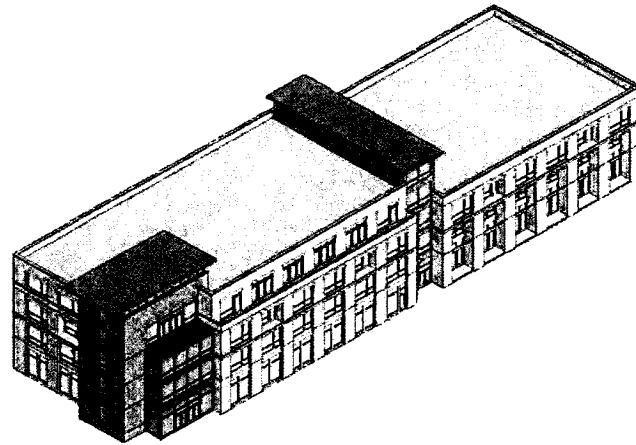

FINAL ASSEMBLY

Further articulation of the facades can be achieved with additional Assembly Kit elements. Refer to the following page for details.

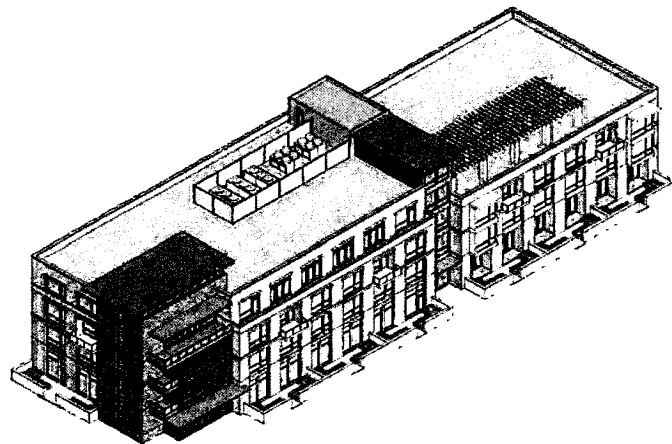

MATERIAL APPLICATION

Apply materials thoughtfully with a coordinated palette throughout the building.

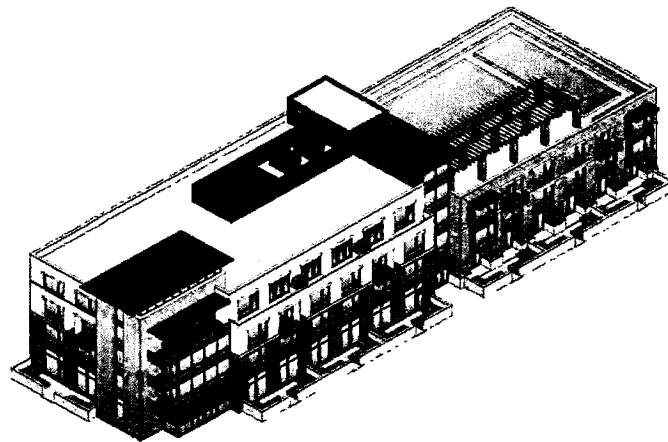



Assembly Kit

Each building is articulated with a system of bays. Within this system, additive elements from the Assembly Kit are organized. The appropriate elements that can be added to multi-family buildings are demonstrated below.

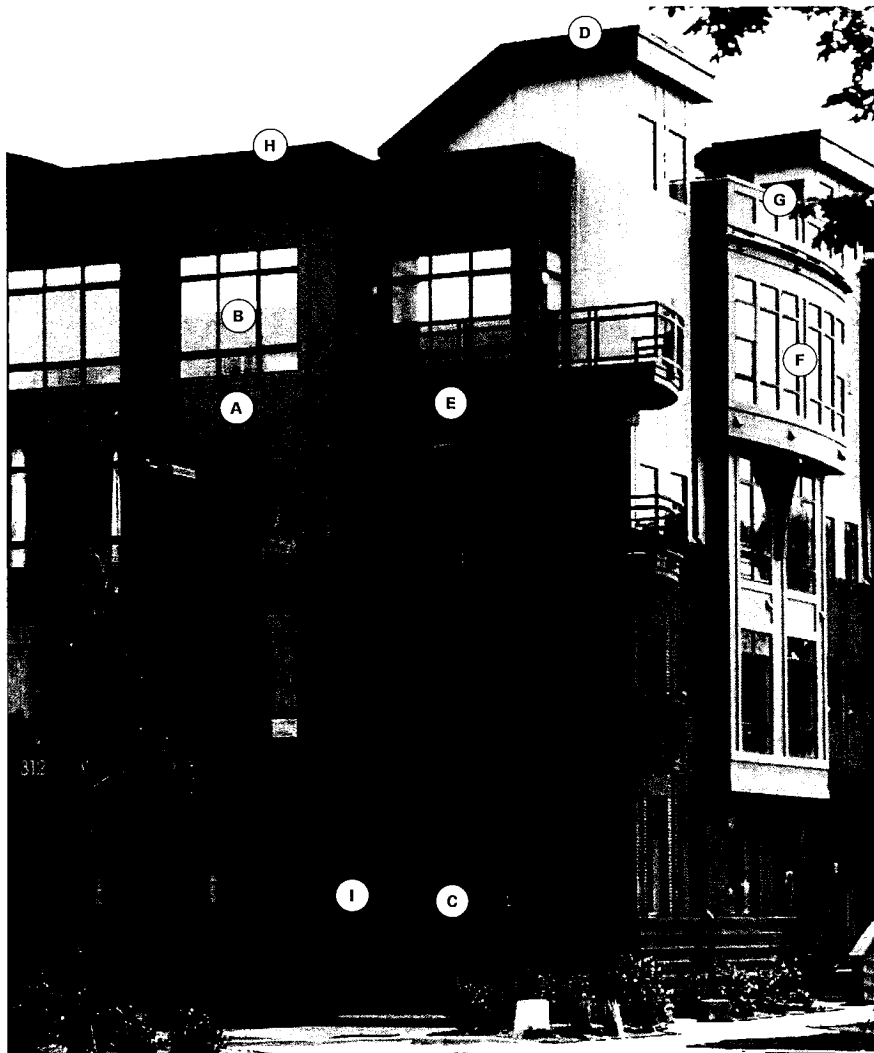

APPROVED ASSEMBLY KIT

Reference the following sections in the Assembly Kit.

A. BAY ARTICULATION

Refer to Section 1

B. WINDOWS

Refer to Section 2

C. ENTRANCE

Doors: Refer to Section 2a
Entrance Elements: Refer to Section 4b

D. ROOF FORM

Refer to Section 3

E. SHADING DEVICES

Refer to Section 6a

F. WINDOW BAYS AND BALCONIES

Refer to Section 5

G. ROOF TERRACES

Refer to Section 3b

H. MECHANICAL SCREENING

Refer to Section 6d

I. MATERIALS

Refer to Section 7

MIXED USES BUILDINGS

Overview

GUIDING PRINCIPLES

- » Compose long facades into a series of buildings that reinforce a human scale and create a varied, attractive skyline.
- » Highlight the building base and entry to increase the richness of the pedestrian experience.
- » Detail the building top to add interest to the building's skyline.
- » Compose facades with a combination of horizontal emphasis to establish a pedestrian scale and vertical emphasis for landmark elements and an enhanced skyline.
- » Avoid monotonous repetition of elements without changes to placement and/or detailing.

Mixed-use buildings are 3 or more stories in height and larger in scale. Buildings should be articulated to reinforce a pedestrian scale. Therefore, at intervals of 50 to 125 feet there should be either a change of plane, material, architectural style, window pattern, or height. There is a one- or two-story base, a middle area of several stories, and a top which can be either one or two stories in height. Ground-floor facades of mixed-use buildings have storefronts with significant use of glazing and common lobby entrances for upper floor uses. The fenestration patterns on the upper floors of mixed-use buildings can be larger and grouped together.

Hotels with ground-floor retail or restaurant uses may be up to 8 stories tall.





Basic Structure and Articulation

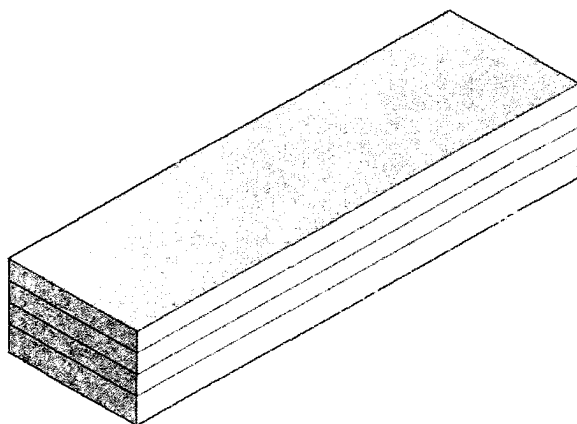

MASSING AND HEIGHT

Basic building mass should be at least 3 stories. Articulate the building with facade divisions that range from 50 to 125 feet in width.

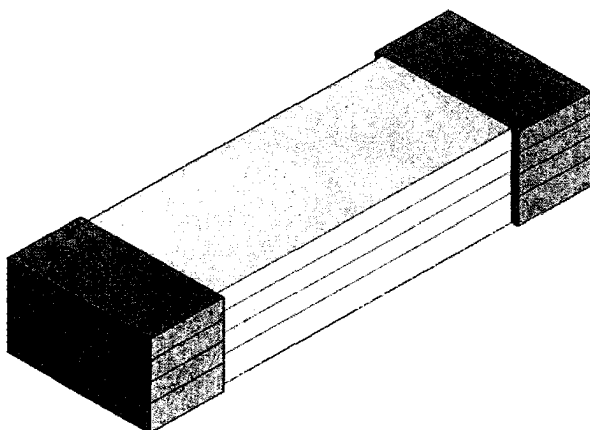

VERTICAL ARTICULATION

All facades over 65 feet wide must be further subdivided. Distinguish these divisions by changes in material, color, plane, architectural detailing, height, fenestration types, or facade composition.

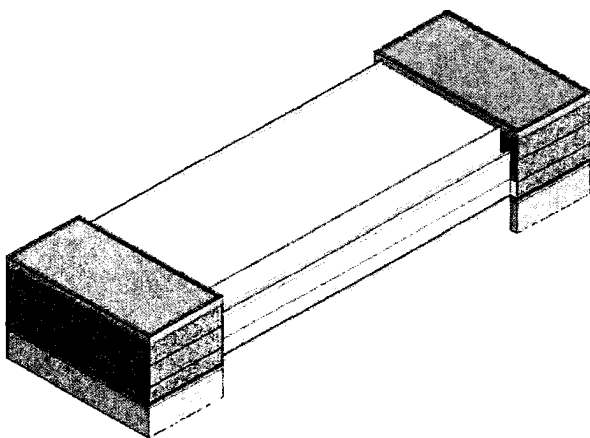

HORIZONTAL ARTICULATION

Horizontal articulation may define a base, middle, and top for each articulated facade. This can be accomplished with window composition, materials, or special features. Buildings over 3 stories must have an expressed base.

MIXED USES BUILDINGS

Facade Composition

FENESTRATION

Ground floors should be articulated with commercial storefronts window patterns that differentiate it from the massing above. Emphasize building entries with architectural elements that can be clearly identified from the pedestrian realm. The maximum architectural bay width at stories above the ground floor level should be 16 feet. Provide vertically proportioned windows in a wide variety of types including groups of tall windows to maximize glass area.

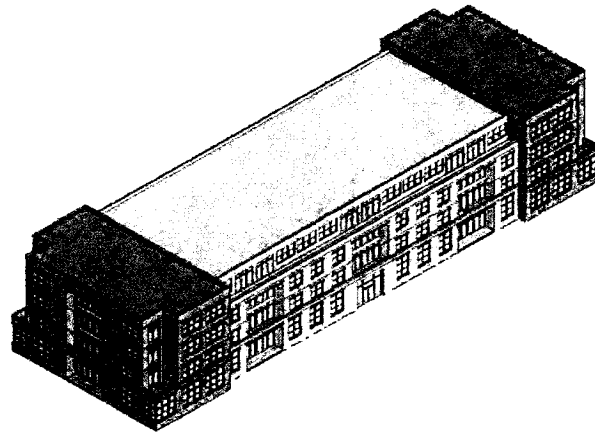

FINAL ASSEMBLY

Further articulation of the facades can be achieved with additional Assembly Kit elements. Refer to the following page for details.

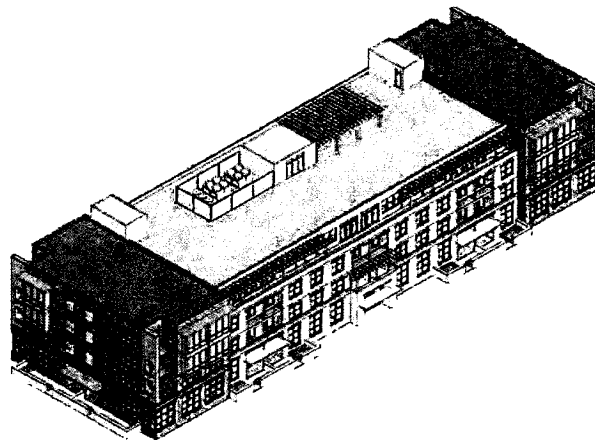

MATERIAL APPLICATION

Apply materials thoughtfully with a coordinated palette throughout the building.

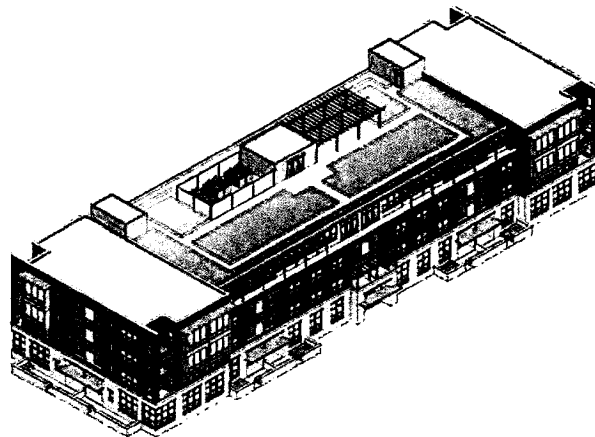

Assembly Kit

Each building is articulated with a system of bays. Within this system, additive elements from the Assembly Kit are organized. The appropriate elements that can be added to mixed uses buildings are demonstrated below.



APPROVED ASSEMBLY KIT

Reference the following sections in the Assembly Kit.

A. BAY ARTICULATION

Refer to Section 1

B. WINDOWS

Refer to Section 2

C. ENTRANCE

Doors: Refer to Section 2a
Entrance Elements: Refer to Section 4b

D. STOREFRONT

Refer to Section 2b

E. ROOF FORM

Refer to Section 3

F. SHADING DEVICES

Refer to Section 6a

G. WINDOW BAYS AND BALCONIES

Refer to Section 5

H. ROOF TERRACES

Refer to Section 3b

I. MECHANICAL SCREENING

Refer to Section 6d

J. MATERIALS

Refer to Section 7

OFFICE BUILDINGS

GUIDING PRINCIPLES

- » Village Square office buildings should blend into the fabric of the surrounding context.
- » Ground floors should have a public expression with large glazing areas, arcades, and other pedestrian-oriented elements.

Overview

Mid-rise office buildings should be articulated to reinforce a pedestrian scale. Therefore, at intervals of 50 to 125 feet there should be either a change of plane, material, architectural style, window pattern, or height.

Office buildings should have a simple and clean design that is coordinated throughout. These buildings must remain as part of the community fabric, allowing the historic buildings to shine as landmark elements. The pedestrian experience is a key element of the Village Square and the office buildings there must reinforce this condition. Ground floors should have a public expression with clearly articulated building entries, generous use of glazing, and arcades.





Basic Structure and Articulation

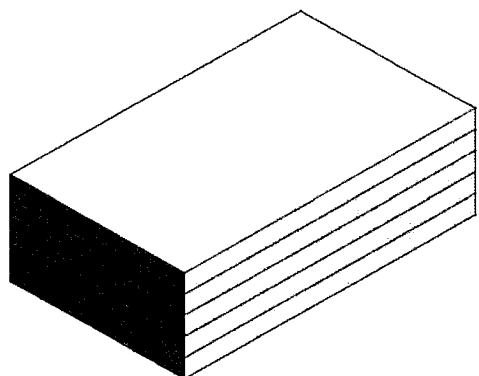

MASSING AND HEIGHT

Articulate the building with facade divisions that range from 50 to 125 feet in width.

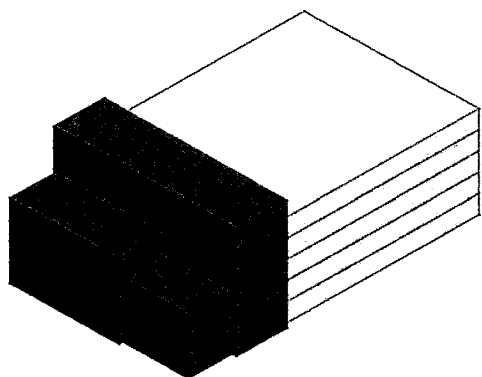

VERTICAL ARTICULATION

All facades over 65 feet wide must be further subdivided. Distinguish these divisions by changes in material, color, plane, architectural detailing, height, fenestration types, or facade composition.

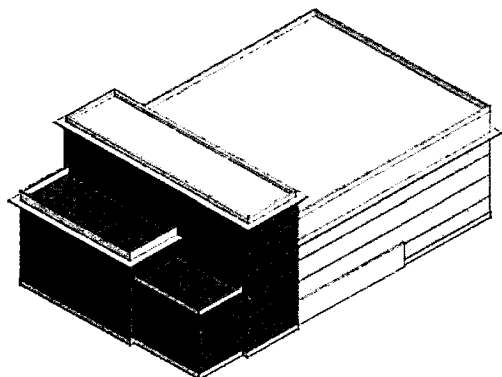

HORIZONTAL ARTICULATION

Horizontal articulation may define a base, middle, and top for each articulated facade. This can be accomplished with window composition, materials, or special features.

OFFICE BUILDINGS

Facade Composition

FENESTRATION

Ground floors should be articulated with commercial storefronts that differentiate it from the massing above. Emphasize building entries with architectural elements that can be clearly identified from the pedestrian realm. The maximum bay width at stories above the ground floor level should be 16 feet. Provide vertically proportioned windows in a wide variety of types including groups of tall windows to maximize glass area.

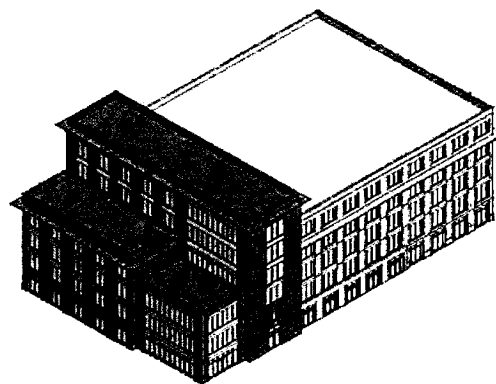

FINAL ASSEMBLY

Further articulation of the facades can be achieved with additional Assembly Kit elements. Refer to the following page for details.

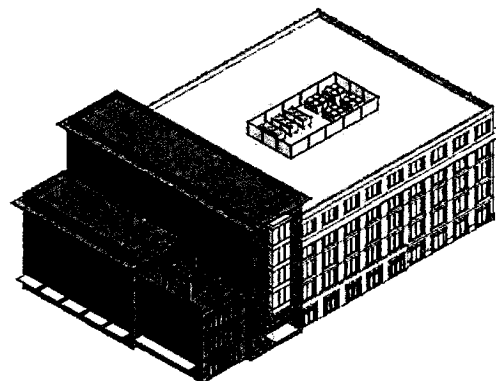

MATERIAL APPLICATION

Apply materials thoughtfully with a coordinated palette throughout the building.

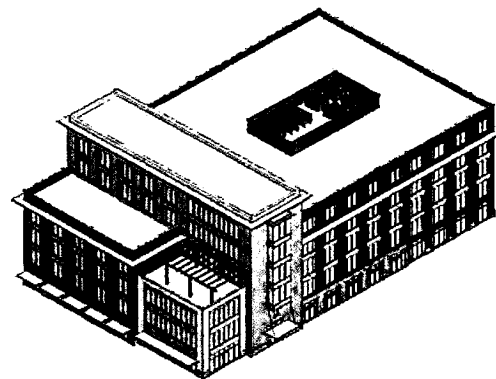



Assembly Kit

Each building is articulated with a system of bays. Within this system, additive elements from the Assembly Kit are organized. The appropriate elements that can be added to office buildings are demonstrated below.

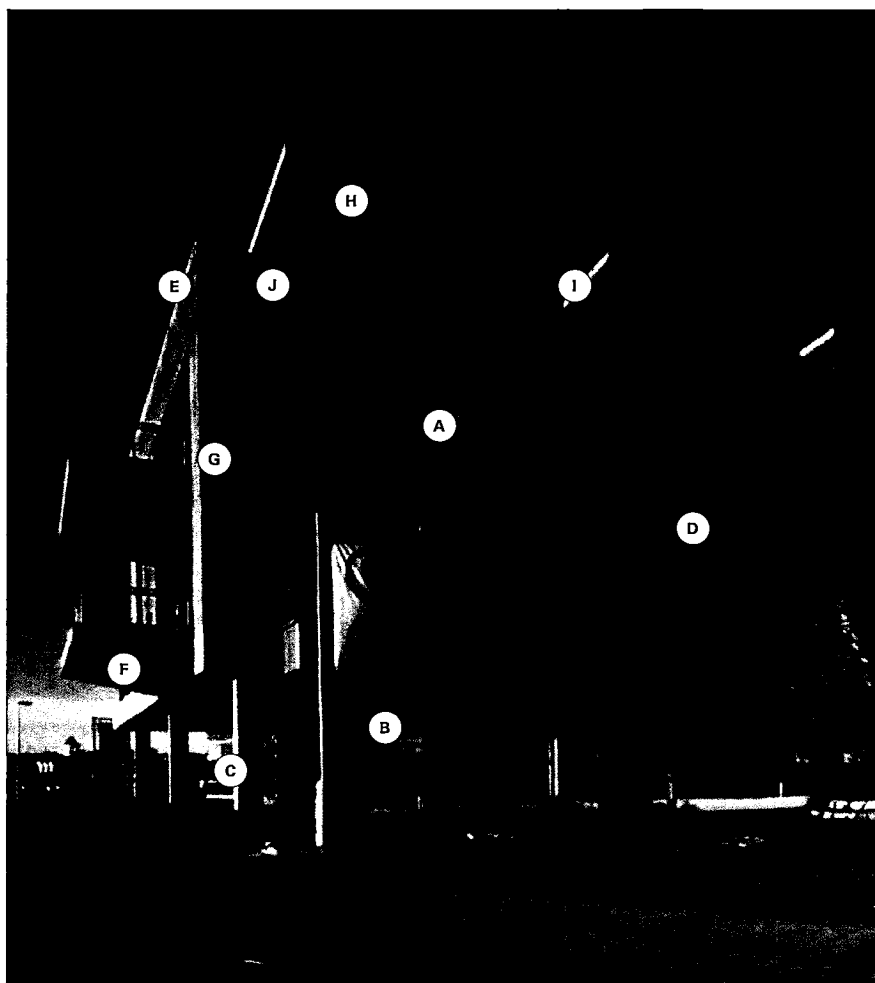

APPROVED ASSEMBLY KIT

Reference the following sections in the Assembly Kit.

A. BAY ARTICULATION

Refer to Section 1

B. WINDOWS

Refer to Section 2a

C. ENTRANCE

Doors: Refer to Section 2a
Entrance Elements: Refer to Section 4b

D. CURTAIN WALL

Refer to Section 2b

E. ROOF FORM

Refer to Section 3

F. SHADING DEVICES

Refer to Section 4a

G. WINDOW BAYS AND BALCONIES

Refer to Section 5

H. ROOF TERRACES

Refer to Section 3b

I. MECHANICAL SCREENING

Refer to Section 6d

J. MATERIALS

Refer to Section 7

FREE-STANDING BUILDINGS

Overview

GUIDING PRINCIPLES

- » Massing should be tall to be seen as a feature building set apart from the street fabric.
- » Entries should be emphasized and face the public realm.
- » Articulate the building on all facades.
- » Fenestration should extend to multiple facades to engage the public realm.
- » Service, loading and refuse areas must be integrated into the building or fully hidden from public view.

Free-standing buildings are building masses that are set apart from buildings that line the street. This building type has a 1- to 2-story height. All sides are exposed so every facade must be attractively designed. Storefront window and door systems wrap as many facades as possible to enable the interior uses to engage the pedestrian realm. Building entries are emphasized and primarily face the pedestrian pathway network. Service, loading and refuse areas are hidden from view by the building or walls.





Basic Structure and Articulation

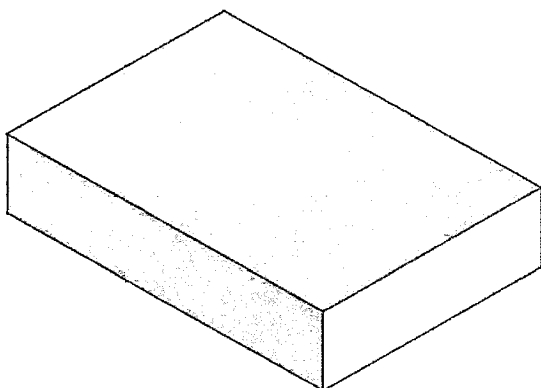

MASSING AND HEIGHT

Basic building mass should be 20 to 30 feet tall. Floor plate area should range between 2,500 and no more than 40,000 square feet.

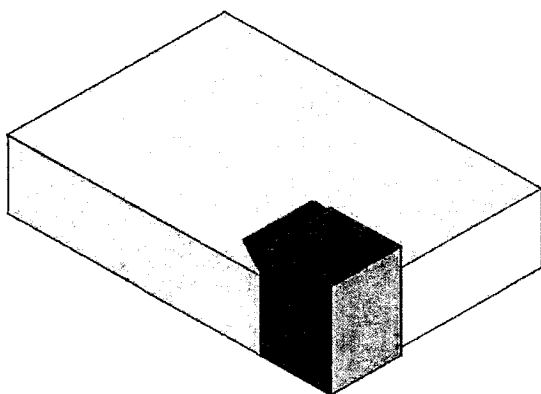

VERTICAL ARTICULATION

Articulate the facade with divisions that range from 20 to 65 feet in width. All facades should be articulated. Distinguish these divisions by changes in material, color, plane, architectural detailing, height, fenestration types, or facade composition.

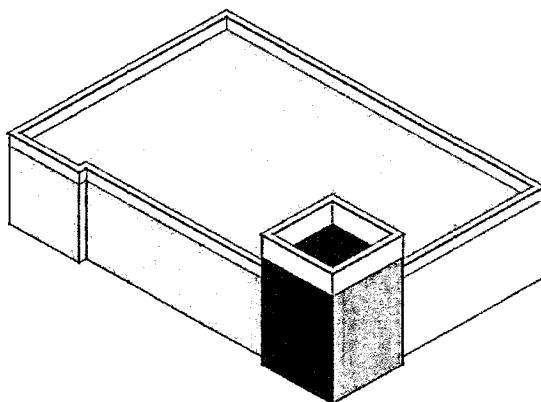

HORIZONTAL ARTICULATION

Horizontal articulation should define a 1 to 1 ½-story base and a top to the building. Differentiation can be accomplished through changes in massing and materials.

FREE-STANDING BUILDINGS

Facade Composition

FENESTRATION

Ground floors should be articulated with commercial storefronts. Emphasize building entries with architectural elements that can be clearly identified from the pedestrian realm. The maximum bay width should be 15 feet.

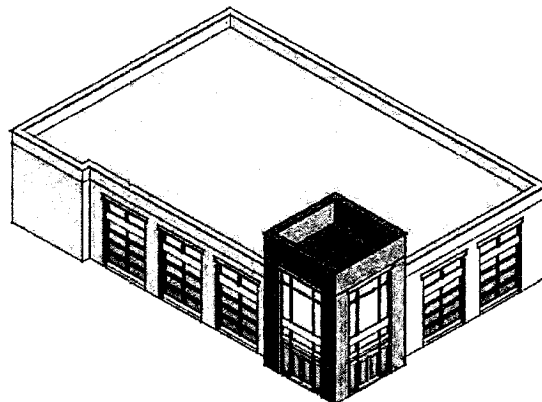

FINAL ASSEMBLY

Further articulation of the facades can be achieved with additional Assembly Kit elements. Refer to the following page for details.

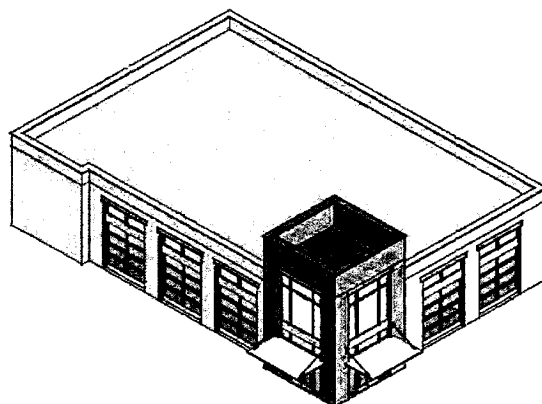

MATERIAL APPLICATION

Apply materials thoughtfully with a coordinated palette throughout the building.

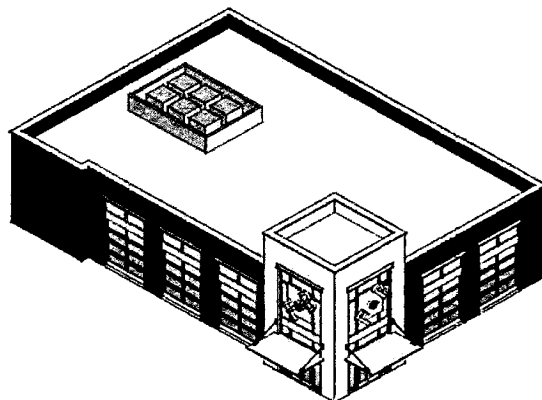

Assembly Kit

Each building is articulated with a system of bays. Within this system, additive elements from the Assembly Kit are organized. The appropriate elements that can be added to free-standing commercial buildings are demonstrated below.

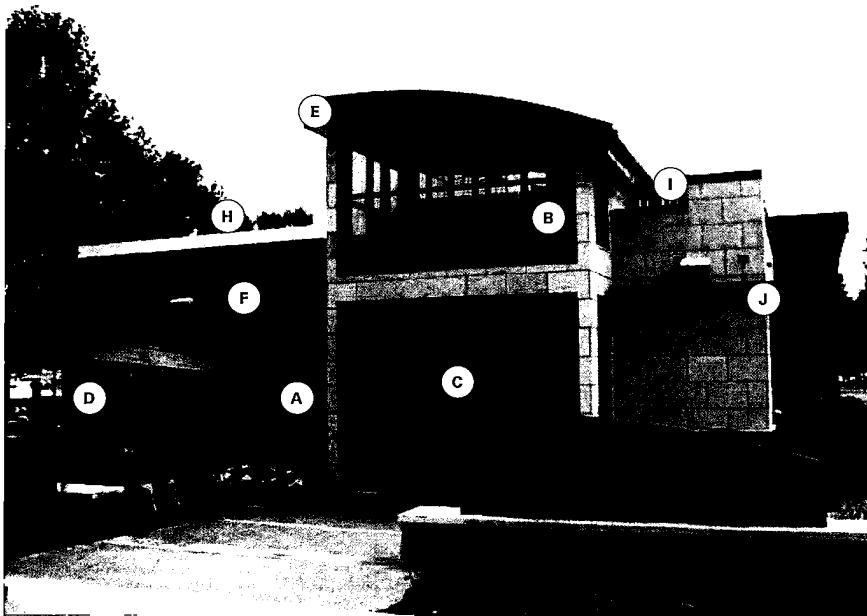

APPROVED ASSEMBLY KIT

Reference the following sections in the Assembly Kit.

A. BAY ARTICULATION

Refer to Section 1

B. WINDOWS

Refer to Section 2a

C. ENTRANCE

Doors: Refer to Section 2a
Entrance Elements: Refer to Section 4b

D. CURTAIN WALL

Refer to Section 2b

E. ROOF FORM

Refer to Section 3

F. SHADING DEVICES

Refer to Section 6a

G. WINDOW BAYS AND BALCONIES

Refer to Section 5

H. ROOF TERRACES

Refer to Section 3b

I. MECHANICAL SCREENING

Refer to Section 6d

J. MATERIALS

Refer to Section 7

LARGE RETAIL BUILDINGS

Overview

GUIDING PRINCIPLES

- » Long facades are articulated with vertical and horizontal elements.
- » Entrances are emphasized with changes in height, projections, and materials.
- » Fenestration is maximized to permit the interiors to engage the public realm.
- » Service, loading, and refuse is situated behind the building, away from public view.

Large retail buildings satisfies demand for large retail uses that cannot be accommodated in other building types. They have large floorplates and face parking areas. This building type has a 1 to 2-story mass, with signage, horizontal and vertical articulation. The pedestrian entrance is emphasized with fenestration. The facade is divided with a series of changes in the plane and height every 50 to 75 feet, with vertical tower elements or horizontal devices articulating a series of alternating bays. Windows with clear glazing are maximized to permit visibility between the interior and the public realm. Service, loading, and refuse is located behind the building or fully screened from public view.

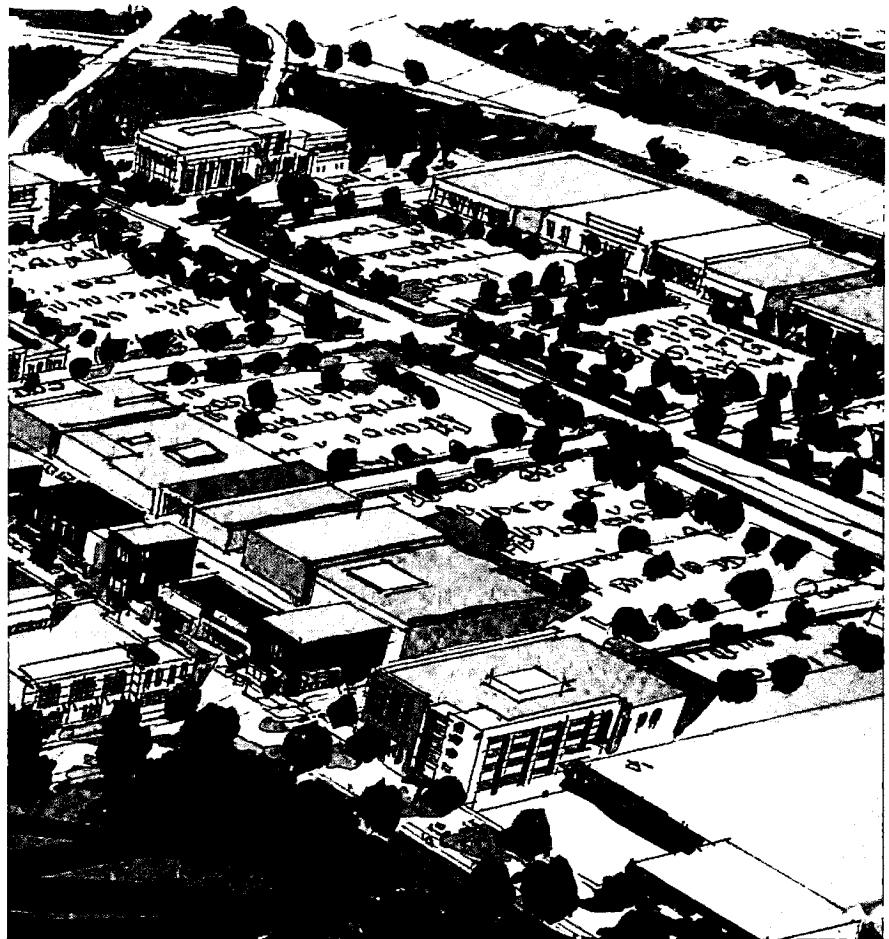



Basic Structure and Articulation

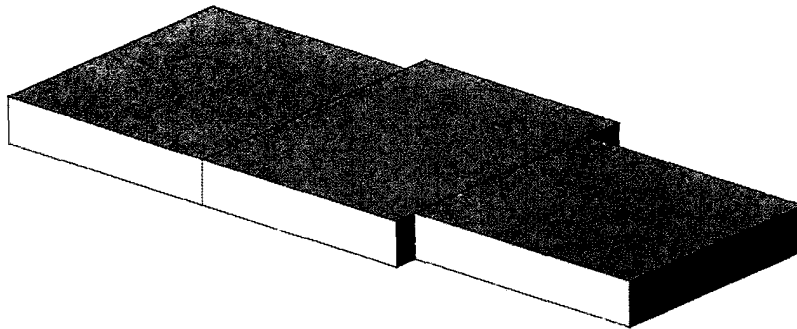

MASSING AND HEIGHT

Basic building mass should be a 1 to 1½-story tall. Maximum dimension of uninterrupted flat facade should not exceed 75 feet.

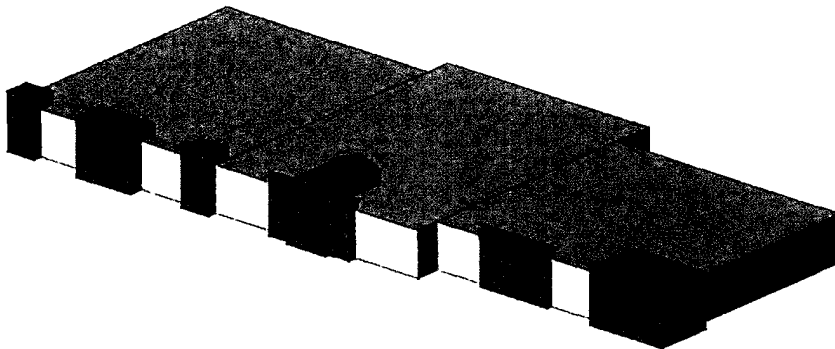

VERTICAL ARTICULATION

Articulate the facade with divisions that range from 15 to 30 feet in width. All facades over 75 feet wide should be further subdivided. Distinguish these divisions by changes in material, color, plane, architectural detailing, height, fenestration types, or facade composition.

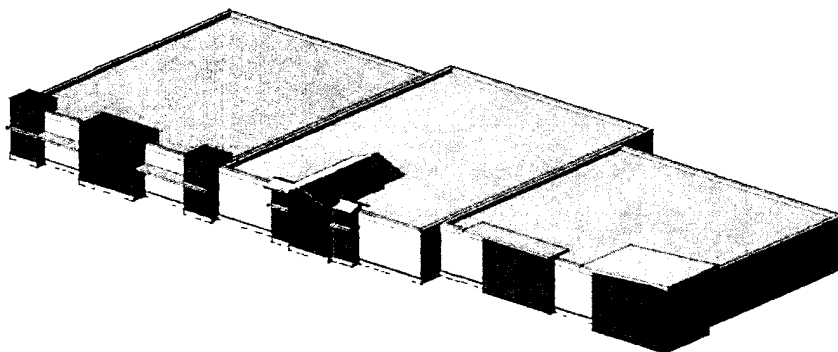

HORIZONTAL ARTICULATION

Horizontal articulation should define a 1 to 1½-story base and may include a top to the building. Differentiation can be accomplished through changes in massing and materials.

LARGE RETAIL BUILDINGS

Facade Composition

FENESTRATION

Ground floors should be articulated with commercial storefronts. Emphasize building entries with architectural elements that can be clearly identified from the pedestrian realm.

FINAL ASSEMBLY

Further articulation of the facades can be achieved with additional Assembly Kit elements. Refer to the following page for details.

MATERIAL APPLICATION

Apply materials thoughtfully with a coordinated palette throughout the building.

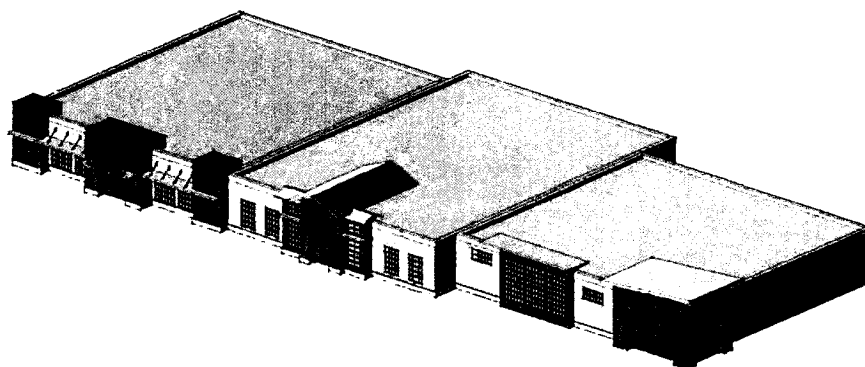



Assembly Kit

Each building is articulated with a system of bays. Within this system, additive elements from the Assembly Kit are organized. The appropriate elements that can be added to large retail buildings are demonstrated below.

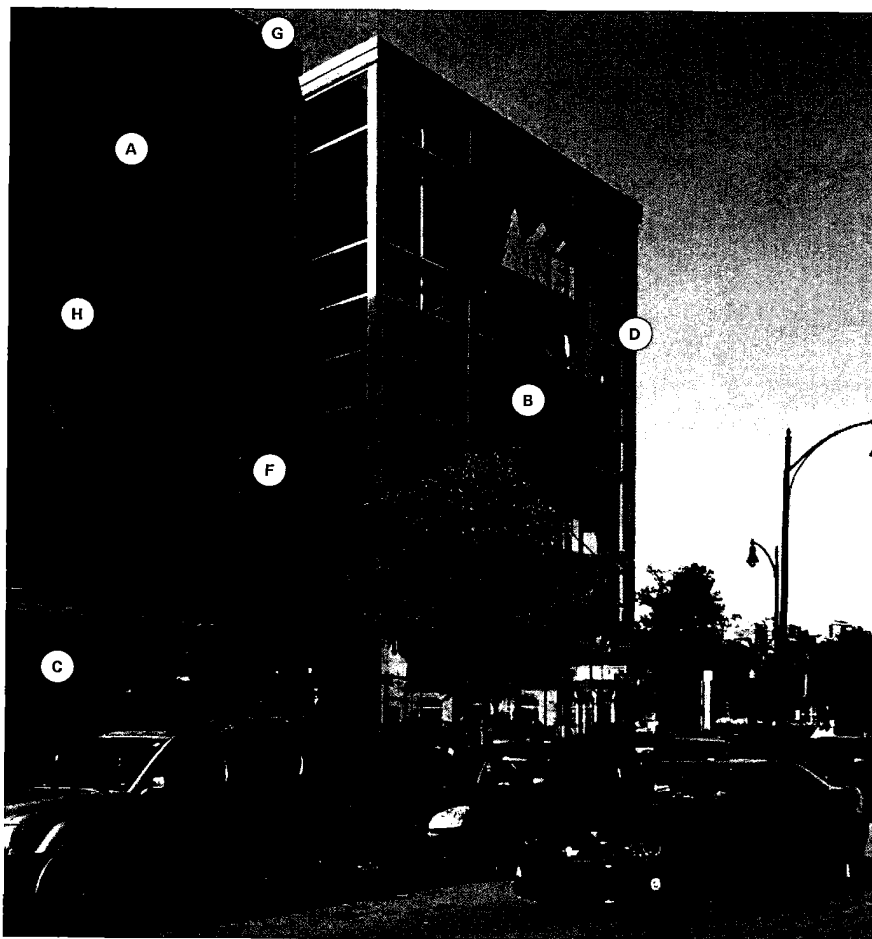

APPROVED ASSEMBLY KIT

Reference the following sections in the Assembly Kit.

A. BAY ARTICULATION

Refer to Section 1

B. WINDOWS

Refer to Section 2a

C. ENTRANCE

Doors: Refer to Section 2a
Entrance Elements: Refer to Section 4b

D. CURTAIN WALL

Refer to Section 2b

E. ROOF FORM

Refer to Section 3

F. SHADING DEVICES

Refer to Section 6a

G. MECHANICAL SCREENING

Refer to Section 6d

H. MATERIALS

Refer to Section 7

STRUCTURED PARKING

Overview

GUIDING PRINCIPLES

- » Structured parking is located to the interior of the block, away from public view.
- » Facades are modulated with bays and material treatments to create vertical openings.
- » Pedestrian entrances and vertical circulation are emphasized and articulated.
- » Ramping bays are hidden from view.

Structured parking is necessary to provide parking for dense development. Multi-story garages are located in the middle of blocks away from view from the public realm.

Visible facades should be broken with projecting bays, and the large openings for ventilation are screened or modulated with vertical elements to create vertically proportioned openings.

Pedestrian entrances and corners are emphasized with vertical articulation, projections, and lighting. Flat parking bays should be located to the perimeter with ramping in the middle of the garage.





Freestanding

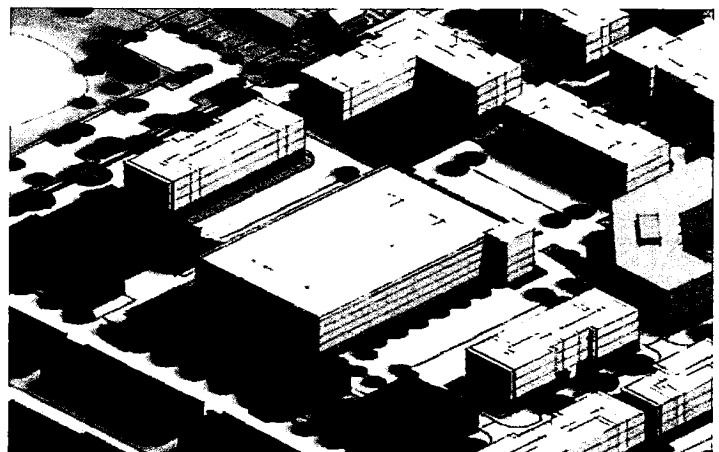
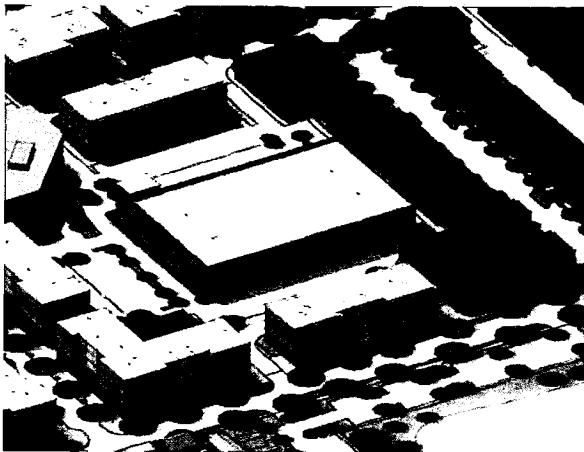
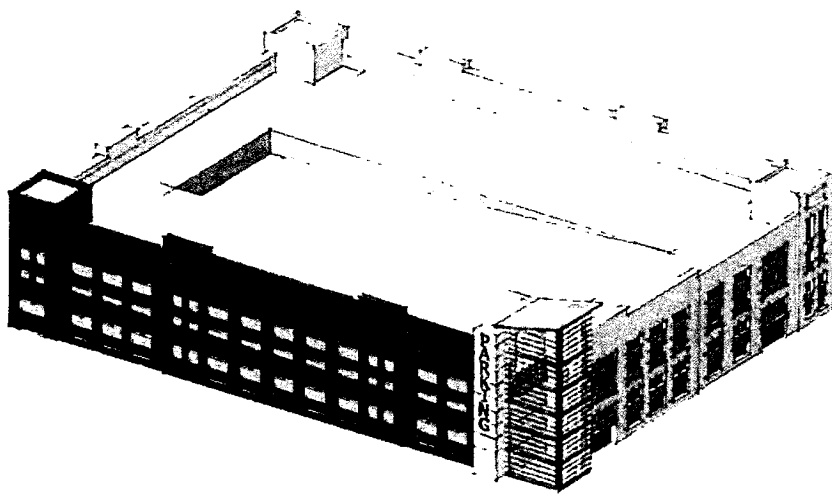

STRUCTURED PARKING

Podium

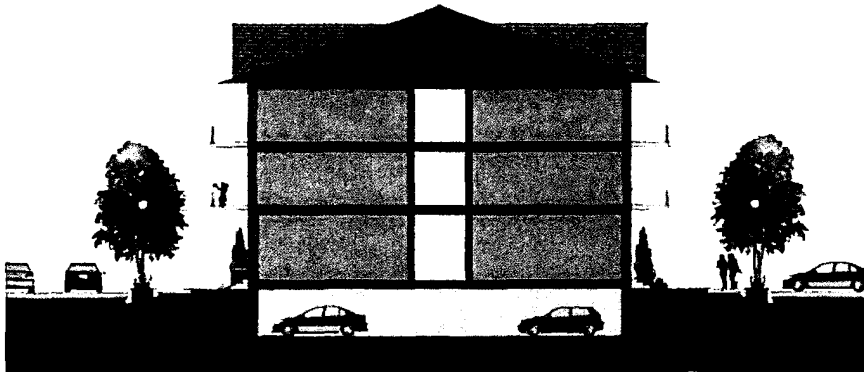

BASEMENT PARKING

- » Parking is in a basement and the first floor is residential
- » Permitted in any location
- » First floor is elevated around 3 feet above street level

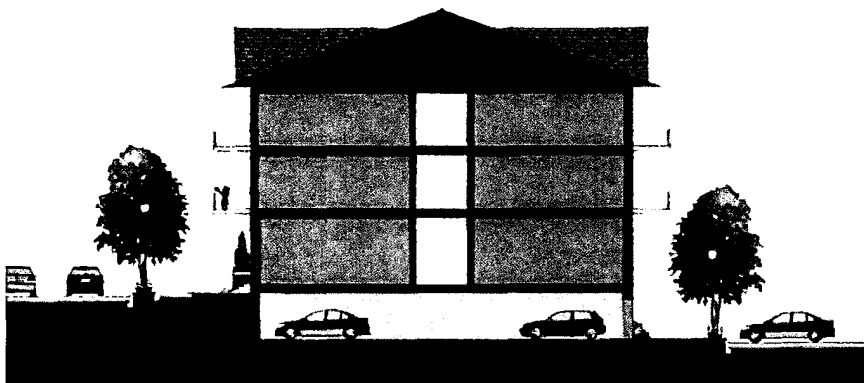

ENGLISH BASEMENT

- » The street frontage is residential and the rear yard is at the level of the basement parking
- » Permitted in any location where the building has a public front and private back
- » The private parking courts are graded lower than the streets.

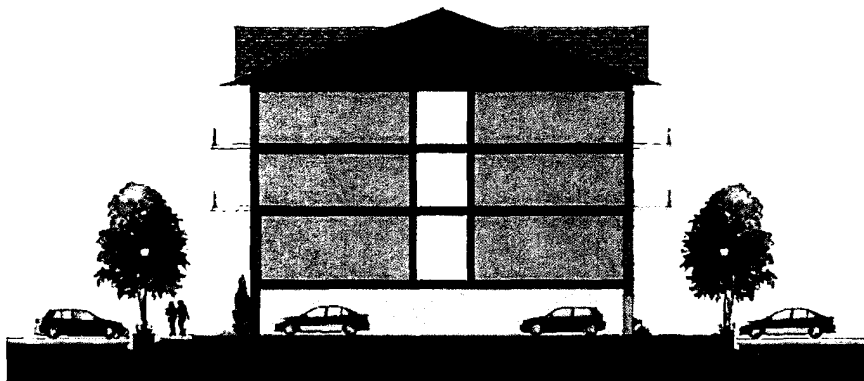

PEDESTAL BUILDING

- » The first floor is used for parking
- » Permitted where the building does not front streets or residential courts
- » Ground floor parking levels are inappropriate fronting streets and public spaces



2-Deck Platform

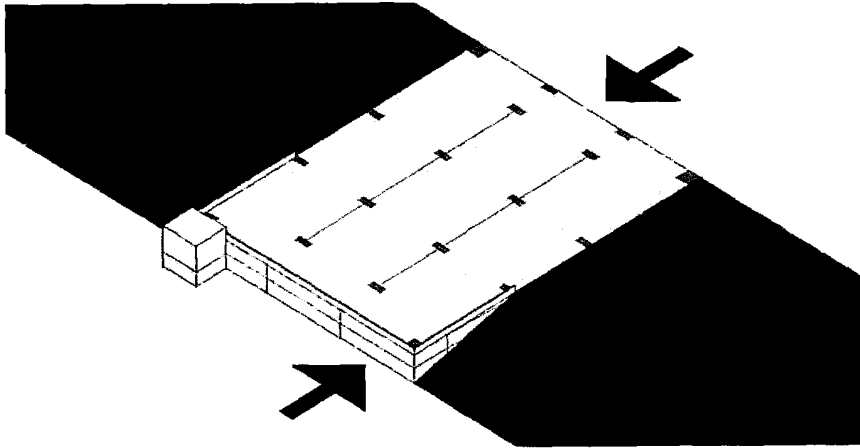

TYPE 1

- » Platform takes advantage of site grading so that one deck is accessed at a higher elevation and the other is accessed below.

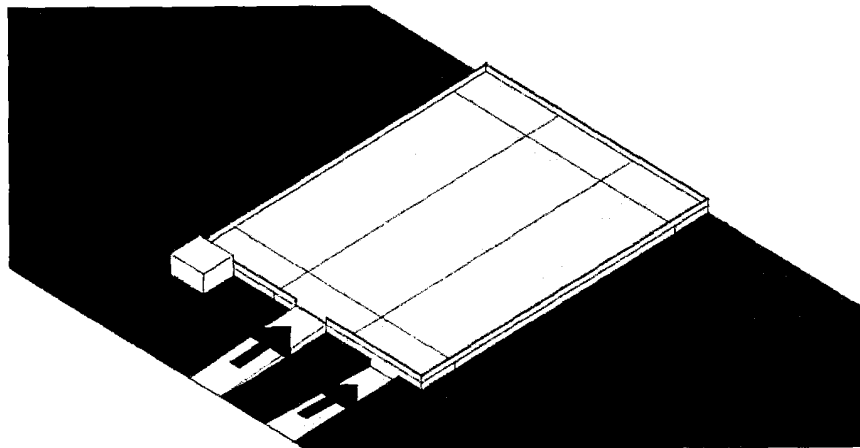

TYPE 2

- » The platform is sunken into the land half a level so that you are ramping down half a level to access to access the lower level and up half a level to access the upper level

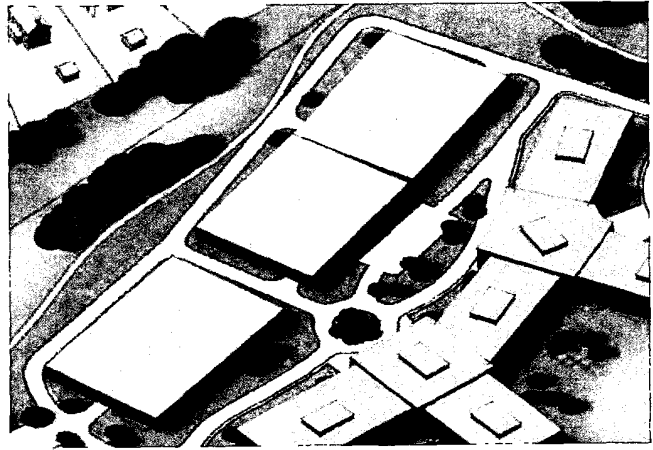
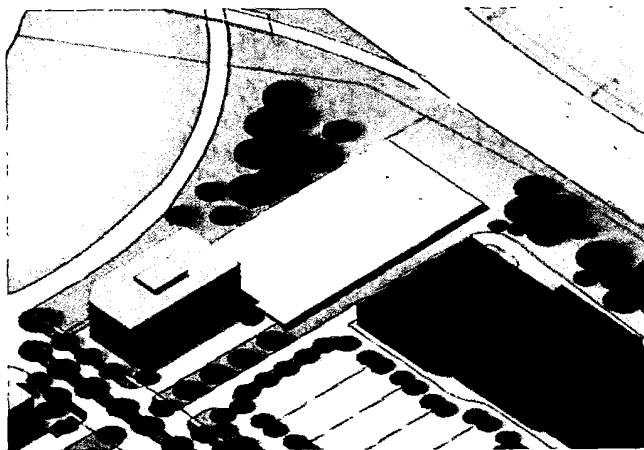





ASSEMBLY KIT

OVERVIEW

ASSEMBLY KIT SECTIONS

1. BAY ARTICULATION

- a. Architectural Bays
- b. Bay Design Principles

2. DOORS AND WINDOWS

- a. Punched Openings
- b. Continuous Assemblies

3. ROOF FORMS

- a. Sloped Roofs
- b. Flat Roofs

4. ENTRANCES

- a. Residential
- b. Storefronts

5. WINDOW BAYS AND BALCONIES

- a. Projecting Bays
- b. Balconies

6. ADDITIONAL ELEMENTS

- a. Outdoor Dining
- b. Lighting
- c. Shading Devices
- d. Screening

7. MATERIALS

Buildings in West Farm / South Farm are to be designed and constructed from a “menu” of design elements. The forms and components that make up the Assembly Kit are derived from inherited architectural patterns of how buildings evolved within the region and the building traditions for each type.

Each building type in the Architectural Patterns section has approved Assembly Kit elements. Refer to the Assembly Kit diagram in each building type section for guidance on which elements are appropriate, then reference the corresponding Assembly Kit pages.

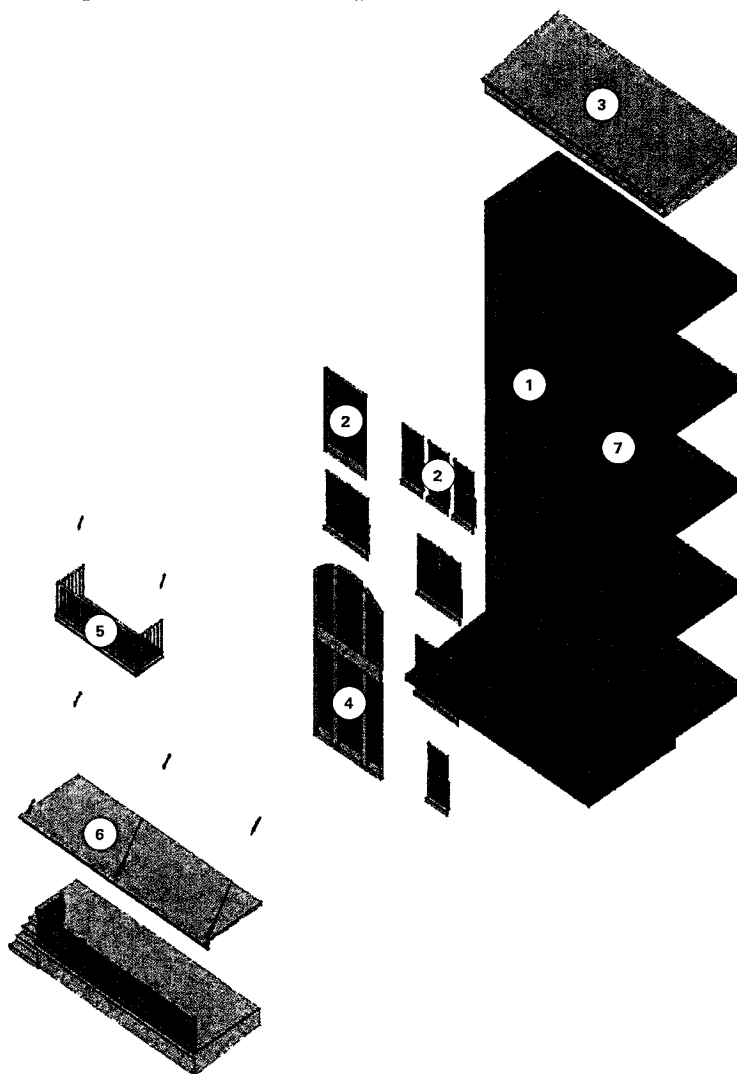



Section 1: Bay Articulation

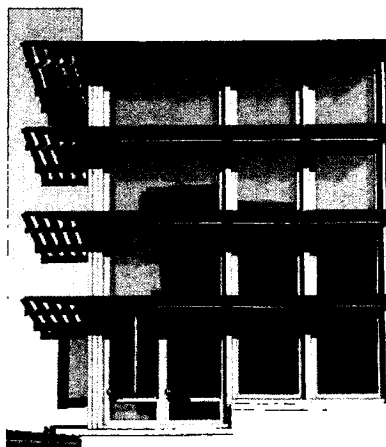

Section 2: Doors and Windows

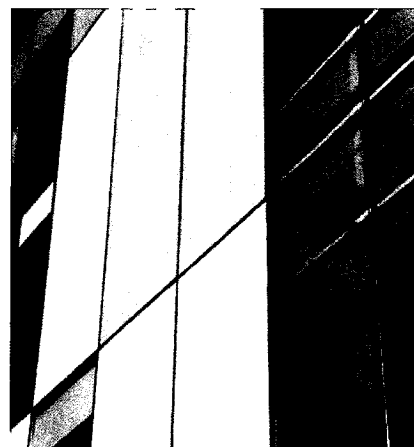

Section 7: Materials



Section 3: Roof Forms



Section 4: Entrances

Assembly Kit

Each building is articulated with a system of bays. Within this system, additive elements from the Assembly Kit are organized. The appropriate elements that can be added to multi-family buildings are demonstrated below.

APPROVED ASSEMBLY KIT

Reference the following sections in the Assembly Kit:

- A. BAY ARTICULATION Refer to Section 1
- B. WINDOWS Refer to Section 2
- C. ENTRANCES Doors: Refer to Section 5a Entrance Elements: Refer to Section 4b
- D. ROOF FORM Refer to Section 3
- E. BALCONY DEVICES Refer to Section 6a
- F. WINDOW BAYS AND BALCONIES Refer to Section 5
- G. ROOF TERRACES Refer to Section 3b
- H. MECHANICAL SCREENING Refer to Section 6a
- I. MATERIALS Refer to Section 7

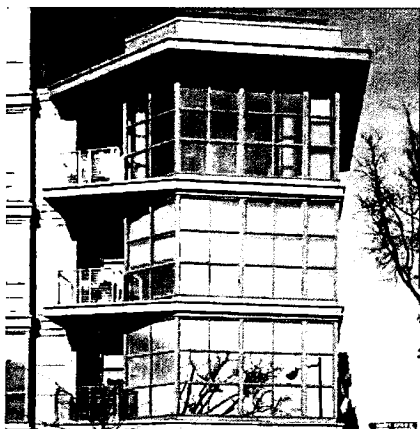

Section 5: Window Bays and Balconies



Section 6: Additional Elements

ARCHITECTURAL PATTERNS 25

Refer to the Assembly Kit diagram in each building type section to determine appropriate architectural elements.

I. BAY ARTICULATION

1a. Architectural Bays

A recognizable feature of notable cities, towns, and neighborhoods is a cadence of building facades, when smaller buildings are lined up to create a continuous street facade. This cadence is created by using a collection of well-composed, regular bays. Taking a similar approach for new development will provide the diversity necessary for lively and active streetscapes.

All street-facing building facades are to be divided into architectural bays. An architectural bay is defined as a vertical division of the exterior of a building marked by doors, windows, projections, roof compartments, or other architectural elements.

Each street-facing elevation more than twelve (12) architectural bays wide shall be composed of multiple building facades.

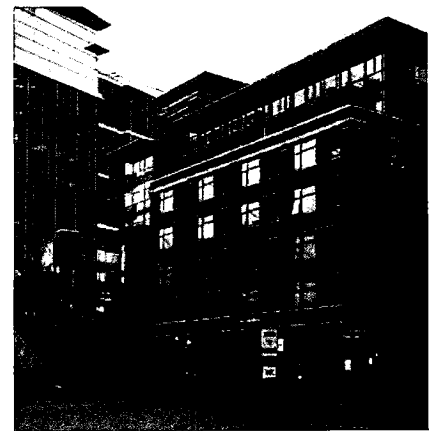



1b. Bay Design Principles

Bay Application

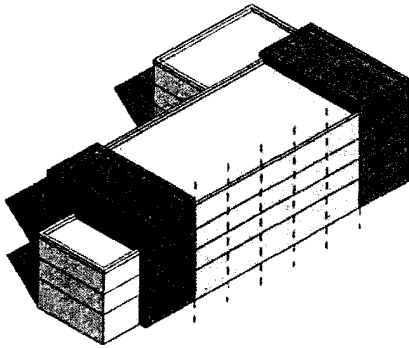

Application of architectural bays breaks the building into multiple facades

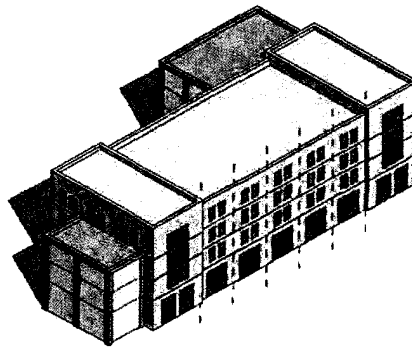

Variation in height and opening compositions within the bays create the look of multiple facades along the streetscape

Bay Design Possibilities



- » Architectural bays shall be 5 to 16 feet wide. Architectural bays are measured at the ground floor level. Bay patterns above shall relate to the bay pattern established at the ground floor, however bays may be combined or divided to achieve architectural variation.
- » Mid-rise, high-rise, and office building facades along any street-facing building shall be:
 - › Offset from adjacent facades
 - › Articulated differently than adjacent facades through at least two of the following ways: substantially different colors, details, and/or materials.
- » Mid-rise, high-rise, and office building facades shall demonstrate unique architectural character from adjacent facades in at least two of the following ways:
 - › Variation in materials
 - › Variation in color
 - › Variation in window types
 - › Variation in bay width
 - › Substantial change in height
 - › Substantial difference in architectural detailing
- » Similar building facades shall not be repeated more than twice along a street-facing elevation. (Not applicable to attached housing types.)
- » Exposed facades of structured parking shall be enclosed by architectural screening that is coordinated with the overall design of the building.

2. DOORS AND WINDOWS

2a. Punched Openings

Individual openings are punched into solid exterior walls to let light, air, or people into the building. The majority of the wall surface remains solid.

- » Individual windows and doors help the building convey a human-scale to pedestrians
- » Single windows or doors can be combined into multi-unit assemblies
- » Appropriate for most building types
- » Asymmetrical window compositions may mix window types
- » Symmetrical window compositions require similar windows
- » Double-hung, casement, or picture windows are permitted
- » Transom windows must align above windows or doors



Windows

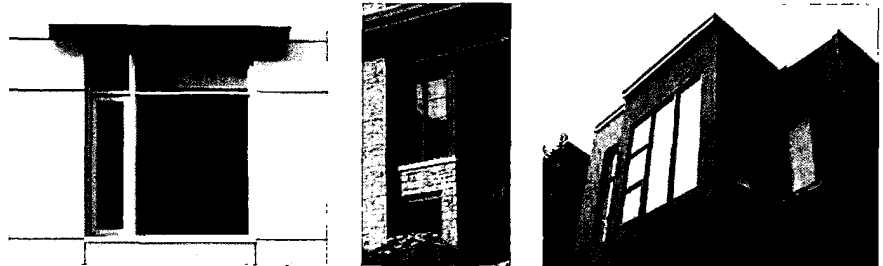

Doors





2b. Continuous Assemblies

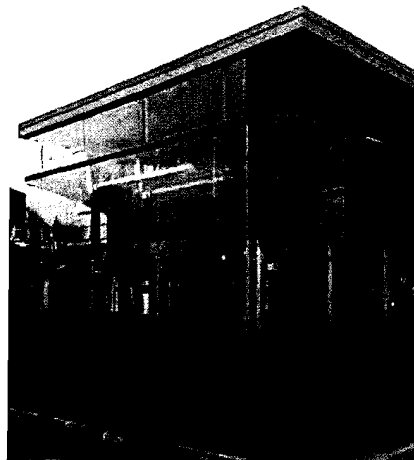
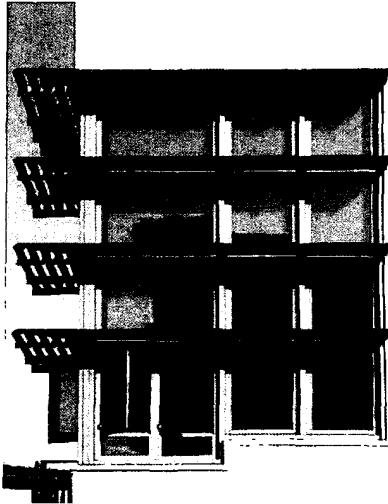

All or part of a solid exterior wall is substituted with one made of glass and metal panels composed into a large-scale grid pattern.

- » Provides maximum daylighting and visibility to interior spaces
- » Well suited to larger building types
- » Secondary massing elements are well suited to being fully glazed when attached to more solid primary forms
- » Glass should be selected to provide maximum visibility; Mirrored or heavily tinted glass is discouraged
- » Metal grid pattern should be appropriately designed for the style and scale of the building
- » Continuous glazing should be used minimally on smaller building types

Curtain Wall



Corner Window

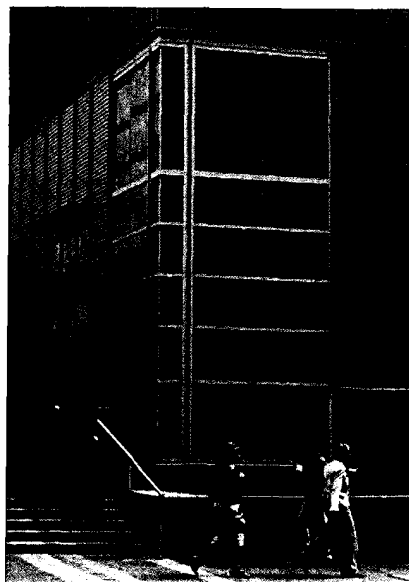

3. ROOF FORMS

3a. Sloped Roofs

Sloped roof forms are built with at least a three-in-twelve pitch and are covered with shingles or seamed metal panels.

- » Reliably and economically shed snow or water to gutter line
- » Gable, shed, and hip forms can be used on a wide variety of styles
- » Deep overhangs protect the building from sun and precipitation while being an expressive design element
- » Well-suited to small and medium scale building types
- » Avoid the repetition of more than four of the same roof type on successive units
- » Fascia width should be minimal
- » Soffits should slope with the roof pitch and should express structural elements like rafters or purlins
- » Deep overhangs are encouraged
- » Primary and secondary building masses should use contrasting roof forms where appropriate

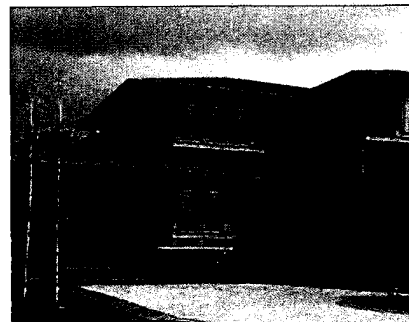

RESIDENTIAL ROOF FORMS	
ARCHITECTURAL STYLE	ROOF PITCH
Arts & Crafts	6:12 to 16:12
English Romantic	8:12 to 20:12
Colonial	4:12 to 10:12
Contemporary	Flat to 12:12



3b. Flat Roofs

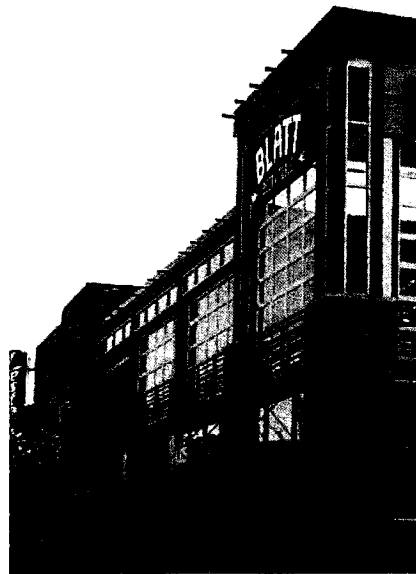

Flat roofs are covered with an impervious membrane and have a minimal slope to allow for drainage.

- » Allow for a larger, more flexible floor plate under a single roof form
- » Building style is expressed through the projection of a vertical parapet wall or a thin horizontal overhang
- » Flat roofs present opportunities for additional habitable outdoor terrace space
- » Works for building types of all scales, but is the dominant choice for medium to large scale commercial development
- » Vary parapet height to create tower forms or hierarchy among the facade bays
- » Horizontal roof overhangs should be constructed to minimize the width of the exposed fascia
- » Depth of projecting overhang must be appropriately scaled to size and style of building
- » Habitable roof terraces with shade protection are encouraged on all building types
- » Green roofs are strongly encouraged where appropriate

Projecting Overhang



Parapet



Roof Terrace

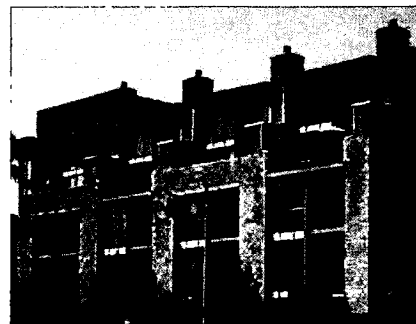

4. ENTRANCES

4a. Residential

Provides a semi-private zone near the front door which separates the house from the street and provides outdoor living space.

- » Creates privacy through distance, change in level, or screening, e.g. landscaping, fence, etc.
- » Provides a protected place for socializing with neighbors
- » Varies in scale from a small stoop or at-grade paved area to a large covered porch or raised landscaped terrace
- » Appropriate for all residential types where each unit has their own exterior door and address
- » Take advantage of corner locations for opportunities to wrap porches or terraces around the unit and for side-street entrances
- » Coordinate railing design with the rest of the residence
- » Provide covered area at front door
- » Accessible ground-level terraces or porches should use screening elements to provide privacy from street
- » When composing a street, stoops and terraces should vary from unit-to-unit



Porch/Terrace

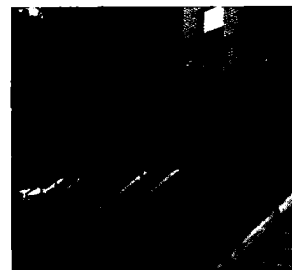

Multi-Family Residential

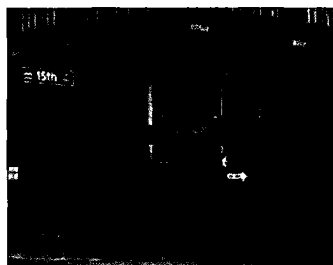



4b. Storefronts

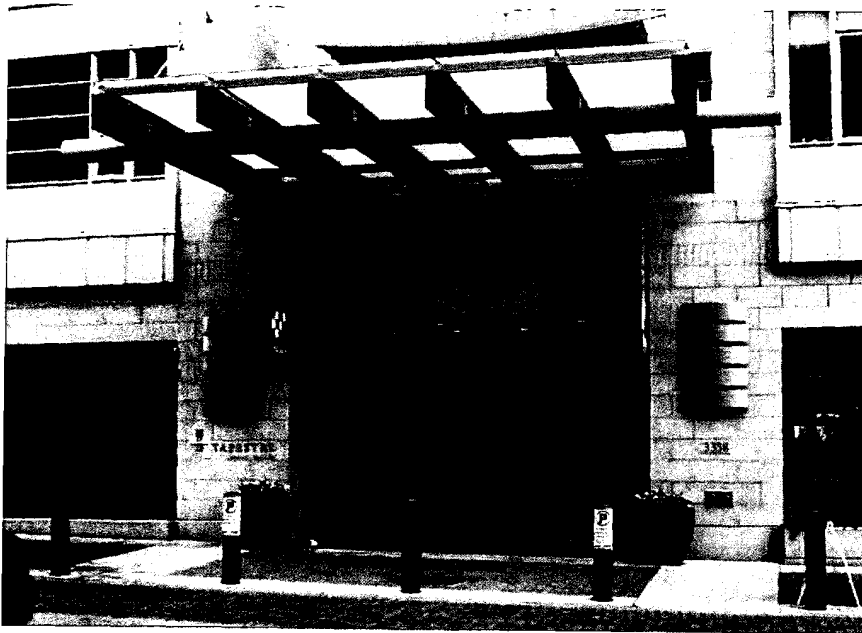

An architectural bay or series of bays which serves as the entrance to a building lobby or retail storefront.

- » Clearly identifies the entrance on a larger building facade
- » Provides protection from the elements or pedestrian and vehicular traffic
- » Maximizes visibility from the street into the lobby or retail space
- » Transparent glass must be used at retail storefronts or entrance lobbies
- » Provide an awning, canopy, or otherwise covered area at doors
- » Scale and composition of entrance should be consistent with the rest of the facade
- » Material and color of entrance assemblies should be coordinated with the design of the building

Commercial/Storefront

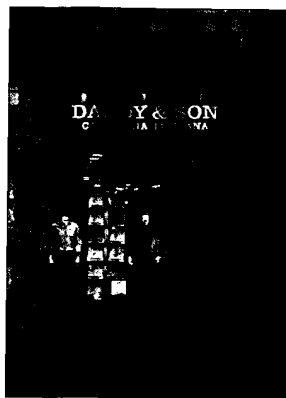
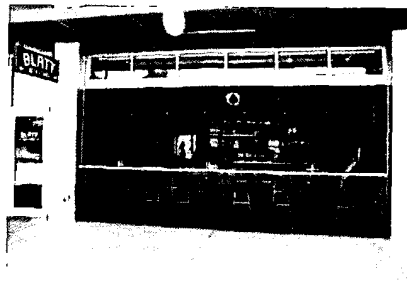
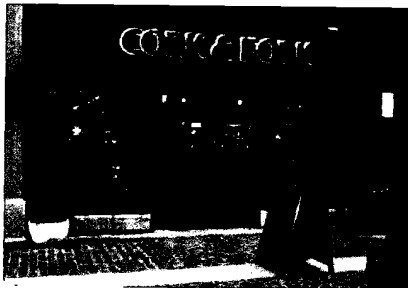

5. WINDOW BAYS AND BALCONIES

5a. Projecting Bays

Create secondary building masses which help to emphasize an individual architectural bay or facade.

- » Can be solid with punched openings or can be fully-glazed glass and metal boxes depending on the style and scale of the building
- » Opportunity to create dramatic, well-lit interior spaces by attaching fully-glazed bays to buildings with more solid walls
- » Large, multi-story bays can add a monumental scale to buildings while smaller bays can have the opposite effect, bringing a human scale to otherwise large facades
- » Major bays should have well-composed facades that are complimentary to the rest of the building
- » Take advantage of opportunities for contrasting materials, colors, or glazing strategies on projecting bays
- » Bay windows should include glazing on the side walls where possible
- » Include habitable terraces where possible on top of large bays



Major

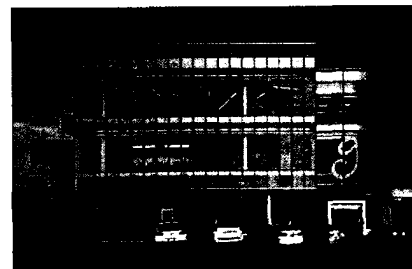
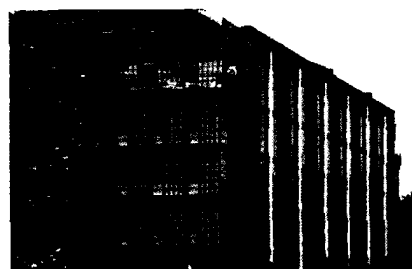

Minor



5b. Balconies



Habitable outdoor spaces that are accessed from the upper floors of (typically) residential buildings.

- » Provides private outdoor living space separated from the noise of the public street below
- » Can be partially or fully recessed to provide additional privacy or protection from the elements
- » Helps to order and animate a larger building's facade composition
- » Creates a sense of human scale and habitation at upper stories
- » Projecting elements of recessed or semi-recessed balconies should be confined to the width of the opening
- » Doors and windows onto balconies should maximize transparency and strengthen the connection between interior and exterior
- » Balconies should be a minimum of five feet deep in order to be usable
- » Walled balconies may contrast in color and materials from the main body massing

Recessed



Projecting



6. ADDITIONAL ELEMENTS

OUTDOOR DINING

- » Terraces provide elevated outdoor space to look out over a street, public space, or natural vista
- » Frontages should offer a variety of seating opportunities, optimizing them on primary streets
- » Garden seat walls, planting, and transparent screens or fences can be used to create separation without comprising visibility and interaction
- » Outdoor Dining areas must not impede the accessible path and must themselves be accessible



LIGHTING

- » Traditionally styled fixtures or appropriately scaled contemporary fixtures are recommended
- » LED lighting is preferred
- » Ground-oriented, pedestrian-scale lighting shall be considered along pedestrian walkways
- » Directed lighting should illuminate the building facade, signs, architectural elements, storefront displays, public sidewalks, and entrances to enhance interest, security, and the comfort of pedestrians at nighttime
- » Parking lot and garage lighting should use warmer color temperatures between 2,000-2,500 Kelvin
- » Fixtures used for architectural lighting shall be aimed or directed to preclude unnecessary light projection

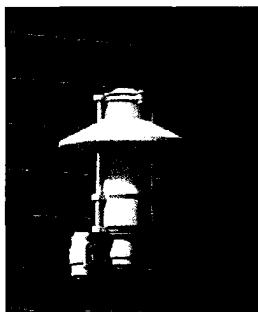
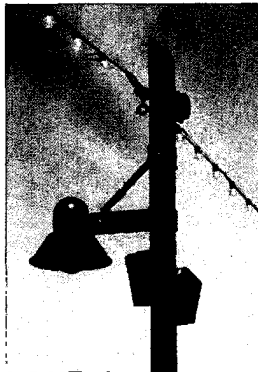

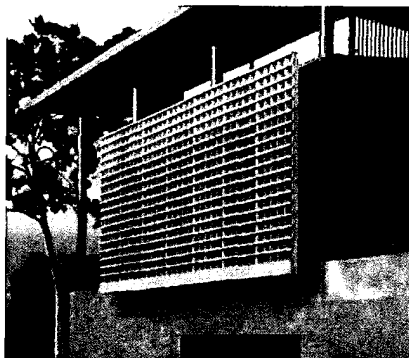
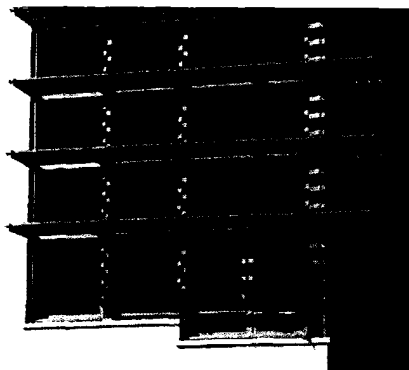

SHADE DEVICES

- » Can be used as either a functional shading device or as a purely compositional architectural element
- » Post-and-beam brise soleils mounted above balconies or roof terraces are encouraged
- » Shades may project horizontally from the facade as a series of blades or a solid fin, or can be applied as a vertical screen parallel to the plane of the building facade
- » Cloth awnings with loose valences are encouraged at retail storefronts

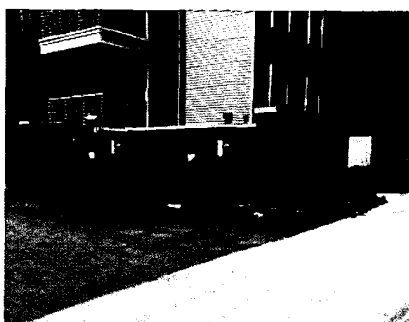

MECHANICAL EQUIPMENT SCREENING

- » Rooftop equipment should be enclosed where feasible so that it is screened from tower views above
- » The form of the roof or cornice should hide mechanical equipment and roof penetrations from street and sidewalk views
- » Vents, grilles, and louvers required on building facades for mechanical systems should be architecturally integrated into the facade design
- » Ground-mounted mechanical equipment should be located at the rear of the building and screened from public view by a hedgerow or wall



7. MATERIALS

APPROVED MATERIALS

- » Cladding: Masonry, cast stone, precast concrete, stone, GFRC metal panels, glass, brick
- » Roofing: Flat roofing systems, standing seam roofing, metal shingle or composition shingle (Residential only), masonry, or precast parapets
- » Curtain Walls: Aluminum framing system with clear glazing, spandrel glass, metal panels
- » Windows: Aluminum window systems, coated steel window systems, clear glazing with "E" coating, spandrel glass, metal panels
- » Trim: Stone and cast stone string courses, lintels, and cornices, Composite
- » Columns: Concrete, precast, GFRC, metal
- » Balconies: Metal, concrete, or wood with metal or glass railing systems
- » Soffits: Concrete, stucco, metal, or fiber-cement
- » Awnings: Canvas, metal, or glass awnings

PRIMARY MATERIALS

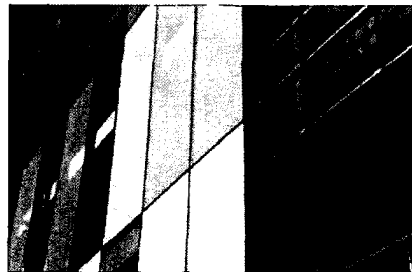

Glass Curtain Wall



Windows/Glazing

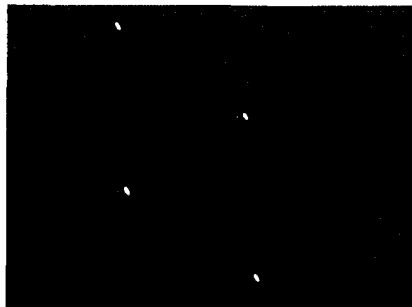

Metal Panel



Wood/Composite Boards

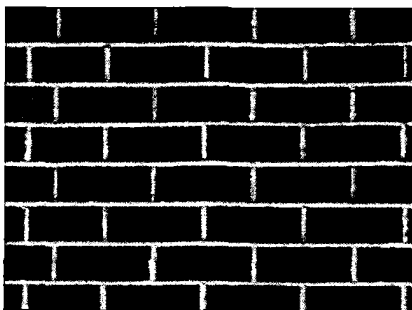

Masonry



GFRC Panel

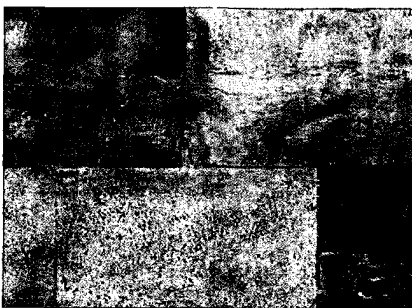

Cut Stone

SECONDARY MATERIALS



Rough Stone

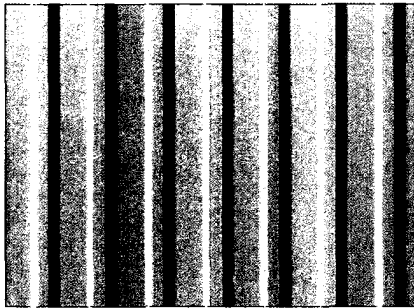

Architectural, Corrugated Metal Panel Systems

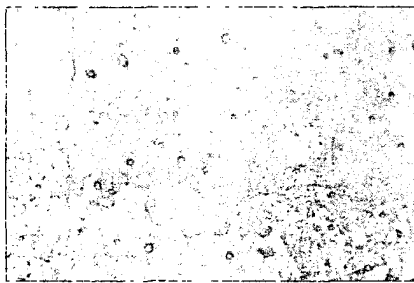

Concrete

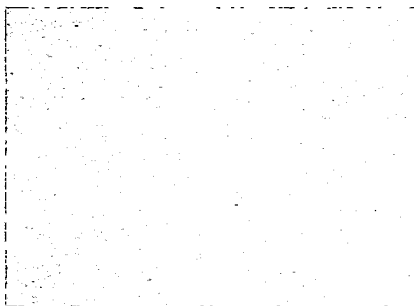

Stucco

DETAILING

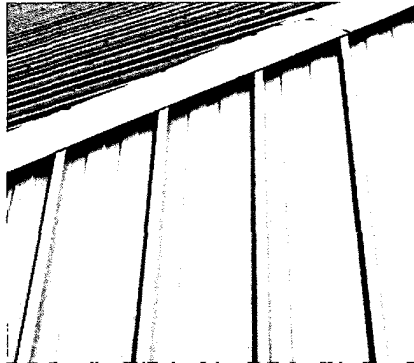

Roof



Soffit and Canopy

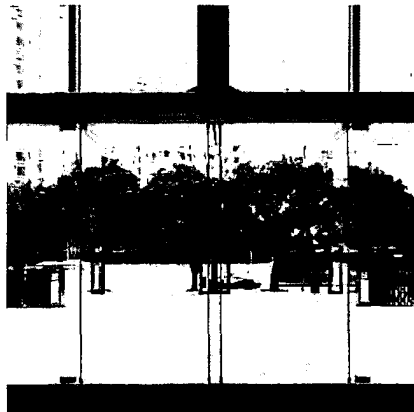

Glazing



Balcony



Lower and Screen

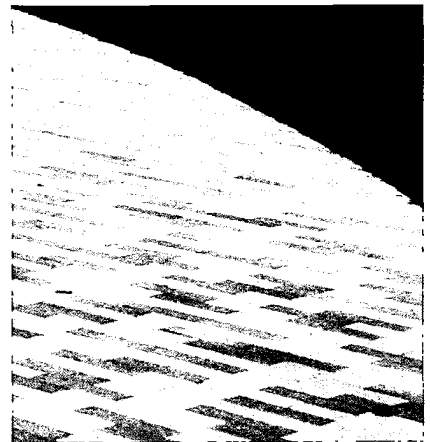

Hardscape



SIGNAGE GUIDELINES

OVERVIEW

Signage in West Farm / South Farm will take on many different forms and voices based on the intended use. Civic or municipal signs and way finding signs will mark streets, parks, the amphitheater, and trails. Signs for individual buildings or users will provide opportunities to add character and variety to West Farm / South Farm. Building signs may be suspended under awnings, projected from the building, applied to or painted on the building, or freestanding within the setback zone. Special public buildings may have signs that become sculptural elements

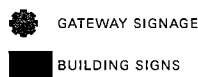
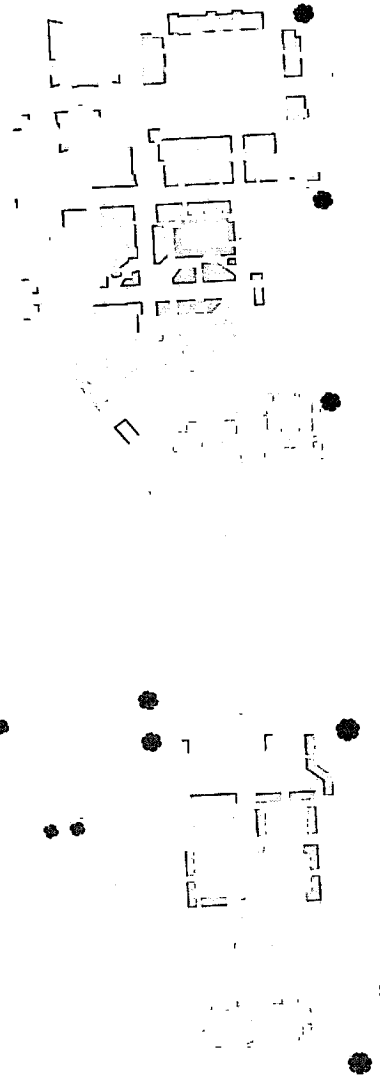

Objectives

There will be several coexisting sign voices within the community, with different characters from subtle to vibrant, that provide variation and visual interest. Accordingly, civic signage will be relatively “quiet,” while commercial, hospitality and retail and entertainment signage may be more “lively.” All civic, residential, and commercial signage should complement the architecture, creating a lively atmosphere and visually enriching the fabric of the overall community.

Signs should work with the other street amenities in establishing the character of the street on which they front while clearly identifying a business, encouraging window shopping, and enhancing the pedestrian experience. Avoid an overabundance of signage that creates visual clutter.

A cohesive family of municipal or civic signs should provide a quiet street presence that unifies the community throughout, and becomes the constant backdrop to the widely varying commercial spectrum of signage.

SIZE AND PLACEMENT

- » The design, size, and location of each sign will be reviewed and approved in context with the design of the building to which it pertains and its specific use.
- » Sign area shall be calculated in accordance with the West Farm / South Farm mixed-use agreement sign budget.
- » No signage is permitted within the vision clearance triangle at street intersections.
- » Signs mounted on buildings, other than those that name the building, should be clearly visible from the street level.

REGULATED SIGNAGE

- » Signage will conform to existing signage regulations including the following:
 - › Wall signs for large retailers will be permitted.
 - › Feature signs will be permitted but will be reviewed on a case-by-case basis.
 - › Signs may extend above the roof line, roof peak, or parapet wall and may be illuminated, but will be reviewed on a case-by-case basis.
 - › Entertainment uses may be permitted to have a marquee with reader board or electric lettering and/or internal illumination, but will be reviewed on a case-by-case basis.



Sign extending above roofline



Signs mounted on building and visible at street level

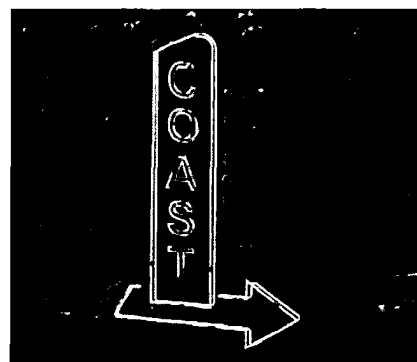

Neon sign



Metal, Wall Mounted Sign

OVERVIEW

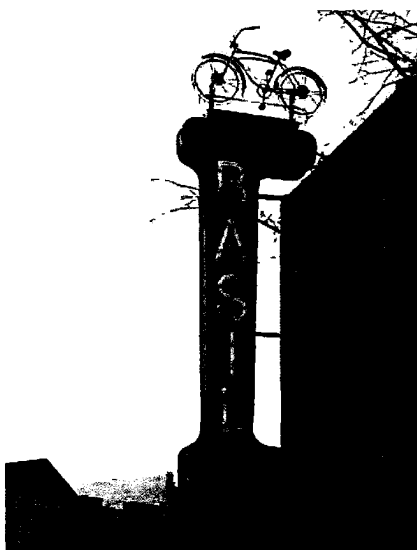

Building mounted, illuminated sign, extending above parapet

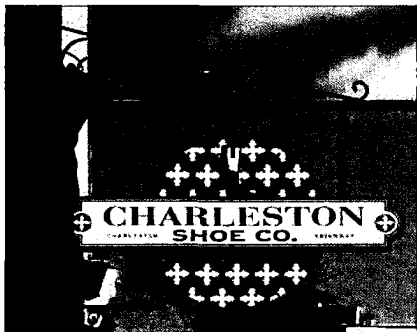

Metal, wall mounted sign

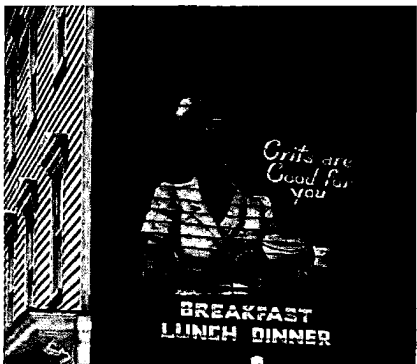

Painted wall mural sign

REGULATED SIGNAGE (CONTINUED)

- › Entertainment uses may be permitted to use neon light fixtures, but will be reviewed on a case-by-case basis.
- › Professionally commissioned painted wall murals may be permitted, but will be reviewed on a case-by-case basis.
- › Building plaques will be permitted.
- » Inappropriate fabrication methods and sign types include the following:
 - › Singular cabinet construction light boxes with acrylic faces
 - › Exposed raceways
 - › Glossy acrylic sides and faces
 - › Internally illuminated fabric awnings
 - › Vacuum formed plastic graphics
 - › Off-the-shelf plastic sandwich signs
 - › Tinted storefront windows
 - › Inflatable objects
 - › Sky strobe lighting

SIGN TYPES

- » Temporary Signage
 - › Temporary signage shall conform to existing signage regulations for Community Identification, Informational, and Directional Signage
 - › Signage shall be sized to be appropriately scaled to its specific location and adjacent uses.
 - › Signs may vary in expression and have a unique character.
- » Commercial Signage
 - › Signage shall be appropriately scaled to a specific location and adjacent uses.
 - › Signs may vary in expression and have a unique character.
 - › Standard "off-the-shelf" franchise signs are discouraged. Franchise signage will be reviewed by the Architectural Control Committee for conformance with the West Farm / South Farm master sign plan.

SIGN MATERIAL AND FABRICATION

- » Appropriate signage materials for all signage other than ground signs include the following:
 - › Metal finishes. Polished, brushed, patterned, and weathering metals with natural patinas
 - › Cast/stone concrete
 - › Glass tile/terra-cotta
 - › Wood: painted or natural hardwood (small hanging signs and sandwich boards only)

- › Metal: copper, bronze, brass, architectural metal, raw steel, brushed aluminum
- › Painted or engraved directly on facade surface or glazing
- › Etched glass
- › Acrylic with matte finish, combined with other materials
- › Printed canvas (awnings)
- › Additional materials approved by the Architectural Control Committee
- » Appropriate fabrication methods and signage types include the following:
 - › Fabricated, crafted and assembled signs that combine several complementary materials
 - › The layering and use of materials in innovative ways
 - › The use of environmentally responsible materials
 - › Individual letter forms used as signage
 - › Internally illuminated cabinet construction letters
 - › Additional fabrication methods approved by the Architectural Control Committee
- » Appropriate Ground Monument materials for these signs include the following:
 - › Formed concrete: specialty finish (with integral color or stain)
 - › Brick and stone masonry
 - › Metal: bronze, brushed aluminum, stainless steel, galvanized steel, raw steel
 - › Glass: etched, frosted, colored, luminous
 - › Green screen (metal mesh combined with vines or ground cover plantings)
 - › Additional materials approved by the Architectural Control Committee.
- » Inappropriate ground monument base materials include:
 - › Concrete block (unfinished, textured/colored)
 - › Acrylic
 - › Fiberglass
 - › Wood
 - › Faux Stone



Individual letter forms used as a sign. Colored glass at ground level



Internally illuminated cabinet construction letters



Layering materials in innovated way

COMMUNITY ART

COMMUNITY ART STRATEGIES

- » Art integrated into building facades, canopies, bridges, site features, and signage
- » Public art as a part of private development is encouraged
- » Lighting as art
- » Artful paving and furnishings
- » Overhead, suspended sculptures
- » Visual excitement in the form of screens and interactive art pieces
- » Art as play by creating engaging elements for children and families
- » Ever changing art in the main town square or major parks

Strategic use of community art in West Farm/ South Farm is highly encouraged. Art can be used to activate public spaces, mark gateways, and unify the development. A partnership with local artist communities, like those at the Hot Shop is suggested to bring art into the development. Art can be more than just standalone installations but incorporated into architectural details to continue the theme throughout the development. Existing agricultural elements on site could also function as pieces of art as landmarks or gateway features that represent the rich history of the site.



 POTENTIAL PUBLIC ART LOCATIONS



Art can be incorporated as an architectural elements in the development

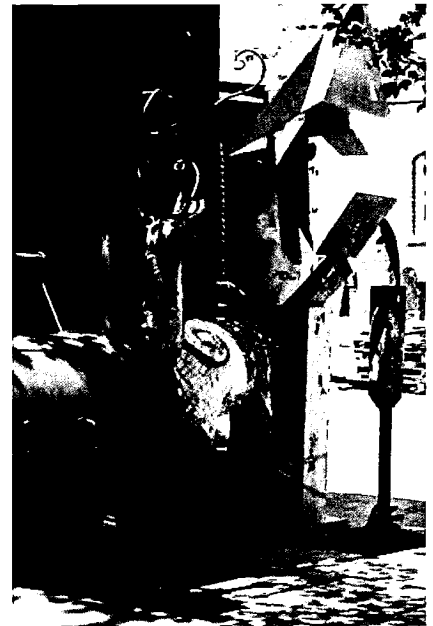

Local Hot Shop Sculptures can add interest to public spaces



Art can a focal point at intersections



Art can be incorporated into landscape elements



Art can be reflective of natural landscapes

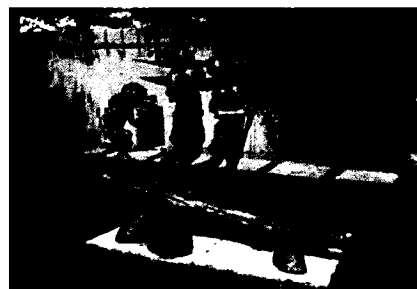

Art can be incorporated into open spaces in the development

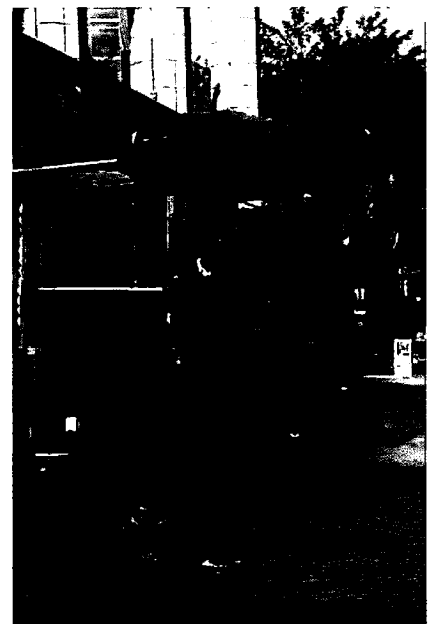

Art with play elements can create interactive experiences



SIGN TYPES



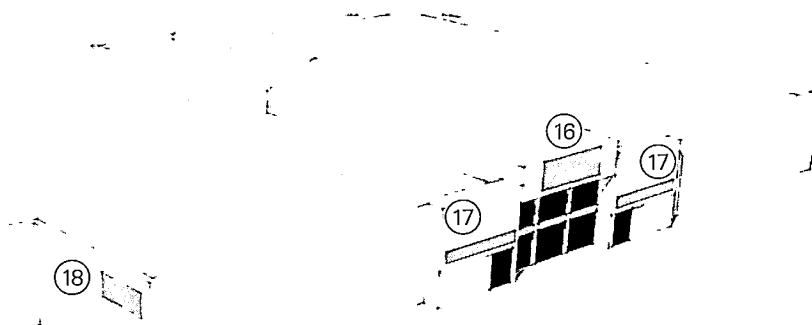

Sign Types Key



- 1 Feature Sign
- 2 Business Identity Wall Sign
- 3 Rooftop Sign
- 4 Canopy Sign
- 5 Awning Sign
- 6 Projecting Blade Sign
- 7 Plaque
- 8 Door/Window Sign
- 9 Temporary/Moveable/Changeable Sign
- 10 Sandwich Board and Menu Board Signs
- 11 Banner Sign
- 12 Painted Wall Sign
- 13 Tenant Directory
- 14 Umbrella Sign
- 15 Monument Sign
- 16 Primary Frontage Wall Sign
- 17 Primary Frontage Information Sign
- 18 Secondary Frontage Wall Sign

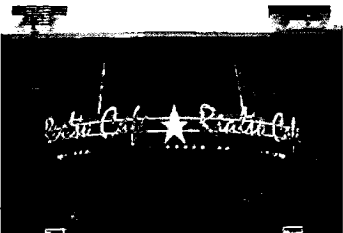
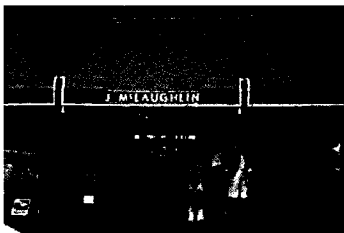

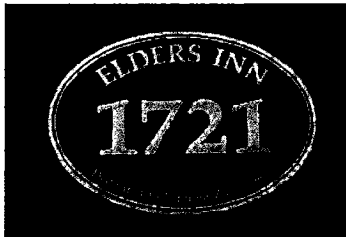
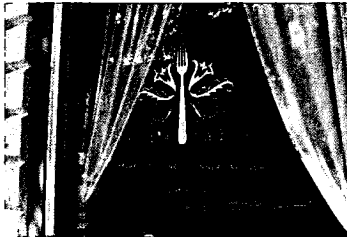

			
	1. FEATURE SIGNS	2. BUSINESS IDENTITY WALL SIGNS	3. ROOFTOP SIGNS
LOCATION	N/A	Architectural sign band above storefront	Above building parapet
MAXIMUM HEIGHT LIMIT	20 ft.	Height of sign band	5 ft. on buildings up to 3 stories, 8 ft. on buildings over 3 stories
MAXIMUM WIDTH FOR SIGN	N/A	Width of sign band	N/A
MAXIMUM AREA FOR SIGN	10% of facade area not to exceed 100 sq. ft. per side	25% of door/window glazed area	250 sq. ft. on buildings up to 3 stories, 350 sq. ft. on buildings over 3 stories
LIGHTING	Internal or external	Internal or external	Internal or external
NOTES			

			
	4. CANOPY SIGNS	5. AWNING SIGNS	6. PROJECTING BLADE SIGNS
LOCATION	First floor occupancy only, minimum clearance of 8 ft.	On top of awning or on the awning flap, one per business	Minimum clearance above a pedestrian passage is 8 ft.
MAXIMUM HEIGHT LIMIT	8 ft.	10 in. flap or 10 in. lettering	4 ft.
MAXIMUM WIDTH FOR SIGN	10% larger than the width of the opening below between architectural piers of pilasters	N/A	3 ft.
MAXIMUM AREA FOR SIGN	N/A	10% of awing space	12 sq. ft. excluding bracket
LIGHTING	Internal or external	External only	Internal or external
NOTES	Max. overhang is 6 ft. from building facade		

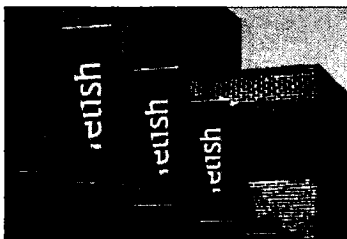
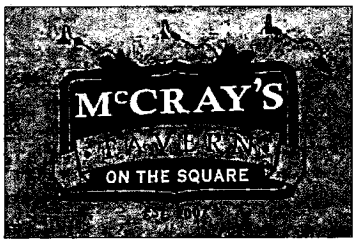
SIGN TYPES

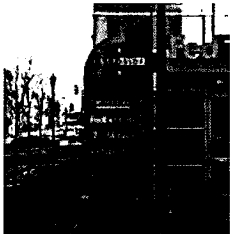
			
	7. PLAQUES	8. DOOR/WINDOW SIGNS	9. TEMPORARY/ MOVABLE/ CHANGEABLE SIGNS
LOCATION	N/A	One sign at entry door glazing and one sign for each window	N/A
MAXIMUM HEIGHT LIMIT	2 ft.	N/A	8 ft.
MAXIMUM WIDTH FOR SIGN	N/A	N/A	8 ft.
MAXIMUM AREA FOR SIGN	4 sq. ft.	25% of door/window glazed area	32 ft. (aggregate of all signs)
LIGHTING	Internal or External	Internal Only	External only
			
	10. SANDWICH AND MENU BOARD SIGNS	11. PROJECTING BANNER SIGNS	12. PAINTED WALL SIGNS
LOCATION	One each per business located outside pedestrian passage	One spaced every 15 ft. minimum	Side & Rear Facades
MAXIMUM HEIGHT LIMIT	Sandwich Sign: 4 ft. Menu Board: 2 ft.	10 ft.	Varies
MAXIMUM WIDTH FOR SIGN	Sandwich Sign: 3 ft. Menu Board: 18 in.	N/A	Varies
MAXIMUM AREA FOR SIGN	N/A	24 sq. ft., 4 ft. maximum projection	Varies
LIGHTING	Not allowed	Not allowed	External only

			
	13. TENANT DIRECTORY	14. UMBRELLA SIGNS	15. MONUMENT SIGNS
LOCATION	N/A	One umbrella sign for every 25 sq. ft. of outdoor dining or service area	Entrances and corners
MAXIMUM HEIGHT LIMIT	8 ft.	Max. flap no greater than 10 in. permitted on valence in height	8 ft.
MAXIMUM WIDTH FOR SIGN	N/A	N/A	N/A
MAXIMUM AREA FOR SIGN	32 sq. ft. excluding plinth	36 sq. in. and is displayed on a maximum of 50% of the panels	64 sq. ft.
LIGHTING	Internal or External	Not allowed	External

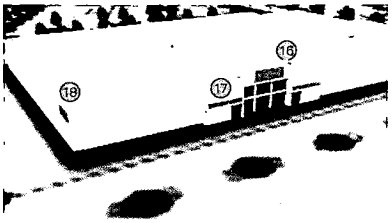
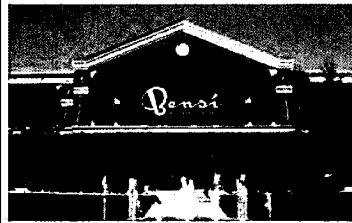

16–18. LARGE RETAILER WALL SIGNS

LOCATION	Subject to Architectural Control Committee review
MAXIMUM HEIGHT LIMIT	N/A
MAXIMUM WIDTH FOR SIGN	N/A
MAXIMUM AREA FOR SIGN	16. Primary Frontage Wall Sign: One sign at 200 sq. ft. 17. Primary Frontage Information Sign: Two signs at 100 sq. ft. each 18. Secondary Frontage Wall Sign: One sign at 100 sq. ft.
LIGHTING	Internal or External



LANDSCAPE PATTERNS

BACKGROUND

Public Open Space Plan

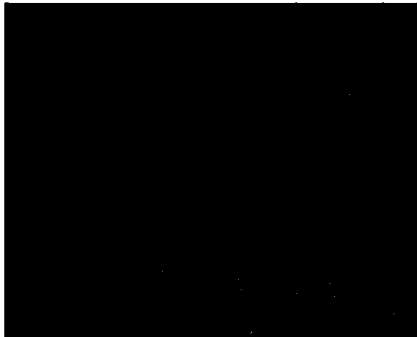
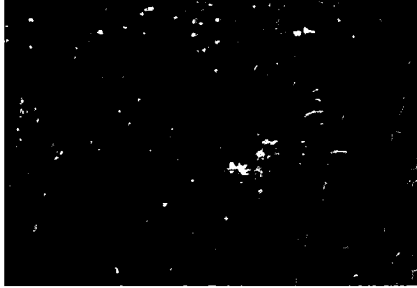

The Omaha Aesthetic

The landscape master plan for the West Farm and the South Farm provides an opportunity to establish a new design aesthetic for the region. This aesthetic will be rooted in the native prairies, savannas, and riparian woodlands that once flourished in the area, and will consist of a palette of native trees, shrubs, grasses, and wildflowers planted in a stylized representation of these ecosystems, and interspersed with more traditional landscaped and manicured areas in appropriate locations. The goal is to create an “Omaha Aesthetic” that is visually pleasing, biologically diverse, and that provides habitat for the native flora and fauna of the region. This aesthetic will restore portions of the landscape to its pre-development condition, yet accommodate current development and market norms. This new aesthetic will be emulated by new development projects throughout the region, and the site’s landscape will be eligible for listing as an affiliate of the Nebraska Statewide Arboretum, helping attract additional interest, visibility, and acclaim.

This new stylized aesthetic, and accompanying architecture, will not only be regionally appropriate and visually attractive, it will also help re-establish the site’s original sense of place. The new landscape will provide a number of additional benefits, including restoring the landscape so that it provides new and enhanced habitat corridors through the site, and biologic diversity benefitting the region’s flora and fauna. In addition, the site will be significantly more sustainable than the typical high-input landscape common throughout the region. Over time, maintenance inputs and costs for watering, mowing, and upkeep will be reduced as the native plant palette becomes fully established.



Existing trail and greenway adjacent to South Farm



West Farm has numerous public open spaces of varying sizes, programmed uses, and landscapes



Native plantings within a small community park



Trail running along a woodland edge



Single-family homes fronting onto natural area



Single-family homes fronting onto formal green

OVERVIEW

Landscape Patterns for Private Development



The landscape on private lots within the residential neighborhoods and mixed-use districts should compliment the overall landscape of West Farm and South Farm.

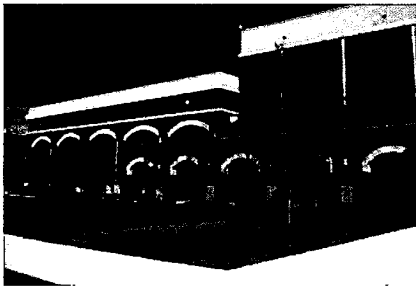

Successful mixed-use districts and residential neighborhoods present a cohesive design vision among not only the architecture of buildings, but their landscape elements as well. At West Farm and South Farm, the landscape on private lots will employ tenants of the “Omaha Aesthetic” established for public open spaces while emphasizing the style and distinctive elements of their structures. This balance and coordination amongst the various design elements will create an environment attractive to visitors and residents of West Farm and South Farm .

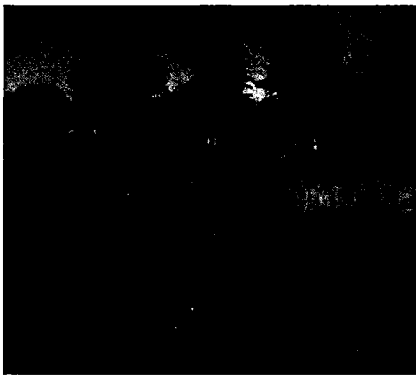

Native grasses in formal planting areas

The West Farm and South Farm master plans present the following three mixed-use districts and three residential neighborhoods:

Mixed-Use District

- West Farm Mixed-Use District
- West Farm Large Retail Area
- South Farm Mixed-Use District

Residential District

- West Farm South
- South Farm East
- South Farm West

These sub-areas are unique in their size and building composition yet unified in their design. The stylized landscape aesthetic, and accompanying architecture, will not only be regionally appropriate and visually attractive, it will also help re-establish the site’s original sense of place.

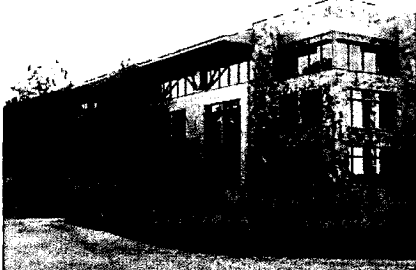

Examples of manicured prairie aesthetic



Market space within West Farm



Native landscaping in a variety of applications

Wildflower and native grass massings

LANDSCAPE PATTERNS

MIXED-USE DISTRICT LANDSCAPES

ESSENTIAL ELEMENTS

- » Stylized native planting and paving/building materials
- » Abundant landscaped islands within surface parking lots
- » Tree and shrub plantings around parking structures that soften the facades and reduce scale
- » Office and retail buildings landscaped with trees and larger shrub massings to help scale structures to a pedestrian scale
- » Tree-lined service drives and sidewalk connections
- » Heavy tree and shrub plantings to screen all service areas
- » Food outlets and restaurants with outdoor dining areas that include ornamental fencing, planters or pots, and overhead coverings appropriate to the building style
- » Apartment buildings and townhouses with appropriate landscape areas along street frontages and rear parking areas
- » Clear and easy connections to public sidewalks and the regional trail system
- » Dedicated vehicular drop-off and pedestrian entrances with specialty paving, site amenities, and a detailed landscape design for each office building

Landscapes within the mixed-use districts of West Farm and South Farm will have a more manicured prairie aesthetic than those which occur throughout the neighborhoods' more naturalistic park and open space system. Urban form will be more structured within these areas, with plant material selections trending more towards natives, but also including introduced perennials, shrubs, and trees.

Due to the nature of lot frontages within these districts, planting zones will be more linear in nature, and often oriented towards the street. Planters, pots, and hanging baskets are encouraged. Care must be taken, though, so that plantings do not block retail storefronts. Native and introduced grasses, sedges, perennials, shrubs, and trees are appropriate. Specialty paving is encouraged to help break up large hardscape areas, as well as to help add texture and character to seating areas, walkways, and small plazas.

Mid-block parking lots and landscape zones should be well landscaped for visual interest, to help reduce the scale of adjacent parking structures and mixed-use buildings, and to help limit the potential heat island effect of large surface parking lots. Connections between parking lots/structures and retail street frontages should be well landscaped, but maintain clear site lines for enhanced way-finding and safety. Landscaping should be designed to help guide vehicular and pedestrian circulation into and out of each block.



Pedestrian zone mixed-use district



West Farm Mixed-Use District

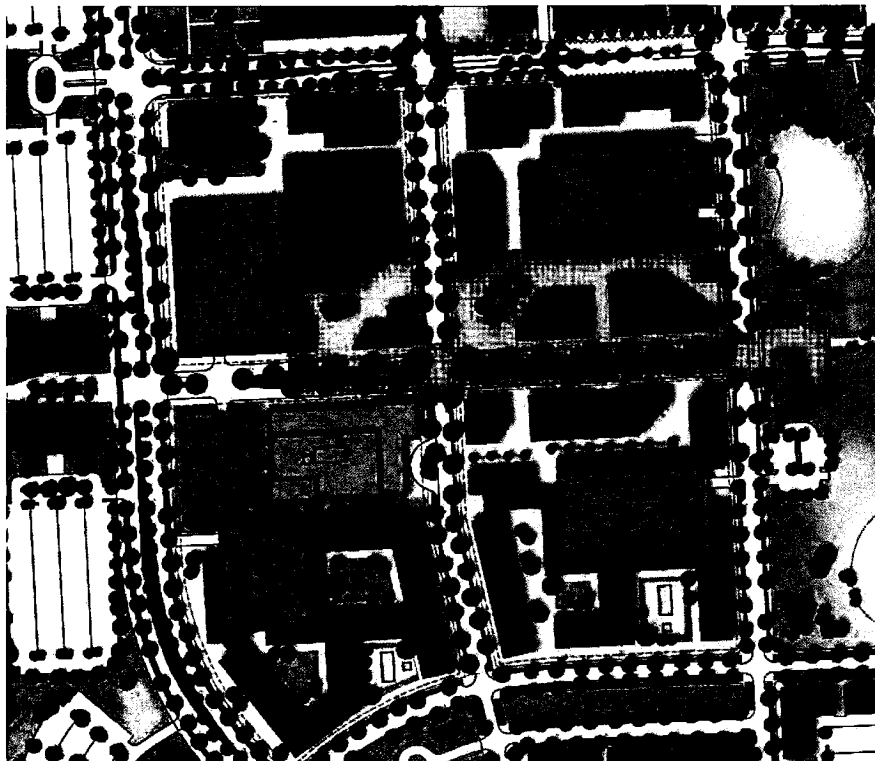

District Concept Plan

ESSENTIAL ELEMENTS

- » Heavily-landscaped surface parking lots
- » Consistent tree plantings along the facades of parking structures
- » Tree-lined sidewalks with understory of stylized prairie plantings along all service drives connecting interior surface parking lots and structures with adjacent public streets
- » Strategically-located trail connections linking the office buildings with the regional trail network
- » Attractive landscapes along the front, side, and rear facades of all apartment buildings and townhouses

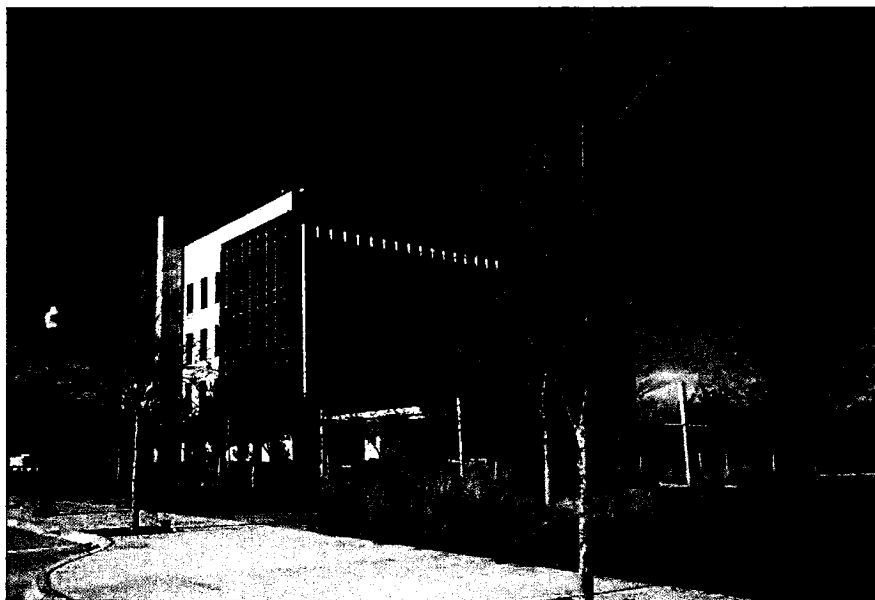

Stylized prairie landscape adjacent to office building

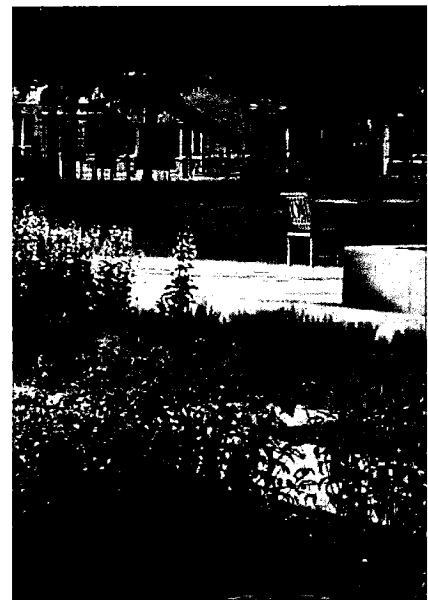

Plaza with native grasses and perennials

MIXED-USE DISTRICT LANDSCAPES

West Farm Large Retail Area

ESSENTIAL ELEMENTS

- » Strategic tree plantings and topographic relief along West Dodge Road frontage to provide visual screening of retail service area but does not block signage
- » Tree-lined landscaped sidewalk connections to the Davenport corridor from all buildings and parking areas
- » Maintain view corridor to office buildings from 144th Street and the 150th Street off-ramp
- » Appropriately-scaled pedestrian zones along retail frontages that include site furnishings, canopies, and landscaping
- » Office building vehicular drop-off and pedestrian entrances with specialty paving, site amenities, and landscaping



District Concept Plan



Parking structure and street access landscape



Native plantings along side-yard of large format retail building

South Farm Mixed-Use District



District Concept Plan

ESSENTIAL ELEMENTS

- » Naturalized landscape areas along Pacific Street that do not inhibit visibility into the district
- » Out-parcels with native landscape areas along Pacific Street and the parking lot
- » Dense screen plantings and/or ornamental fencing along the west and south edges of the large format retail service area
- » Heavily landscaped surface parking lots
- » Tree-lined sidewalks leading to the main north-south axial street and the trails/greenways flanking both sides of the district
- » Well-landscaped apartment building amenity areas and open spaces



Active streetscape with retail and apartment frontage



Apartment open space with native woodland edge



Mixed-use streetscape with accent landscape and site furnishings

RESIDENTIAL DISTRICT LANDSCAPES

ESSENTIAL ELEMENTS

- » Native and introduced planting and paving/building materials
- » Well-defined paths connecting front doors of residence to public sidewalks
- » Foundational shrub, perennial, and grass plantings along front facades of residences
- » Appropriately-scaled alley landscaping
- » Appropriate fencing and/or border plantings along side- and rear-yard boundaries
- » Landscape lighting abiding to dark skies principle

Landscapes in residential districts within West Farm and South Farm will contain a variety of trees, shrubs, perennials, grasses, and sedges. Native varieties are strongly encouraged, but introduced varieties are allowed. In order to help maintain the “Omaha Aesthetic,” planting beds on residential lots should be large and free-form in nature, preferably with grasses and/or sedges as matrix plants, and interspersed with perennials, shrubs, and/or trees. Landscaping should be in scale with a lot’s respective residential architecture and should maintain consistency along respective block frontages. Visibility to and from the public right-of-way is encouraged, and good site lines should be maintained for safety and security. Elsewhere, strong and well landscaped pedestrian connections to public open spaces should be provided. The use of specialty paving materials for sidewalks, patios, and small pedestrian gathering spaces is encouraged. Where topography necessitates, large massings of groundcover and/or masonry retaining walls is encouraged.



Well-landscaped townhouse frontage



Foundation plants along single-family frontage



Single-family homes fronting onto a native grass meadow



West Farm South

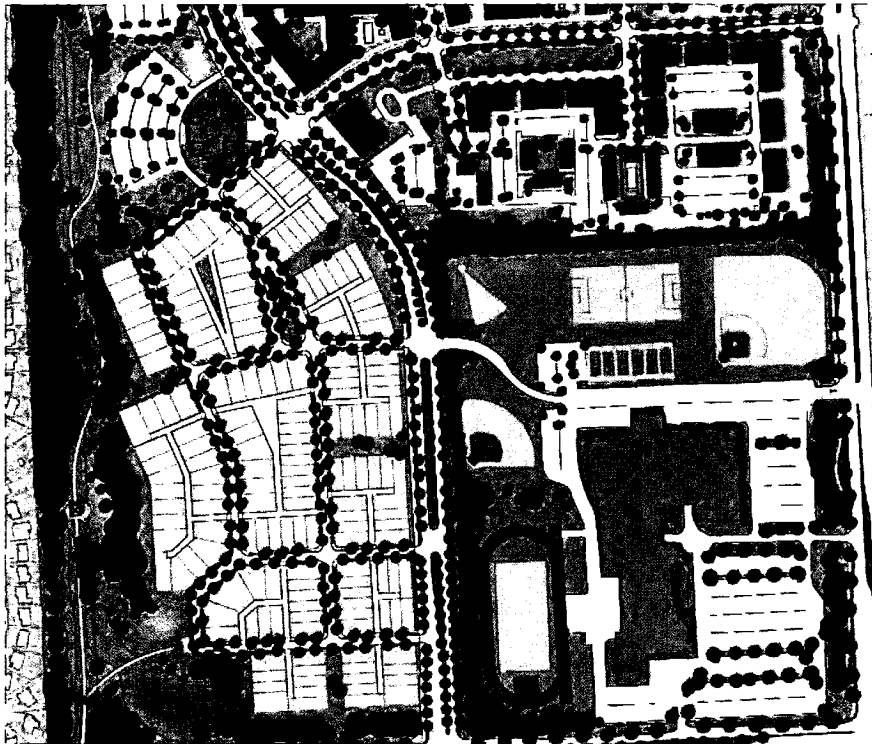

District Concept Plan

ESSENTIAL ELEMENTS

- » Appropriately-detailed and scaled front yard landscaping for homes that front onto common open spaces
- » Transparent rear-yard fencing for lots that back onto trail/greenway along the west property line of the development
- » Dense evergreen screening along the property line separating the apartment sites and Millard North High School
- » Retaining walls or vegetated hillsides of hardy groundcovers used in areas with steep terrain
- » Heavily-landscaped amenity areas and open turf grass spaces for programmed apartment use



Single-family homes fronting onto a trail and greenway



Homes fronting onto community garden



Single-family frontage onto residential street

RESIDENTIAL DISTRICT LANDSCAPES

South Farm West

ESSENTIAL ELEMENTS

- » Fencing and vegetated screen buffers along rear yard property lines abutting the adjacent neighborhoods to the west and the south
- » Opaque fencing and appropriate street-side landscaping for all lots that back onto the adjacent collector street
- » Consistent, 50%-transparent fencing along rear property lines that back onto the campus site
- » Large patios with outdoor amenities, like fireplaces, fire pits, or kitchens, located only in the rear yards of properties
- » Large front yards planted with multiple native specimen trees

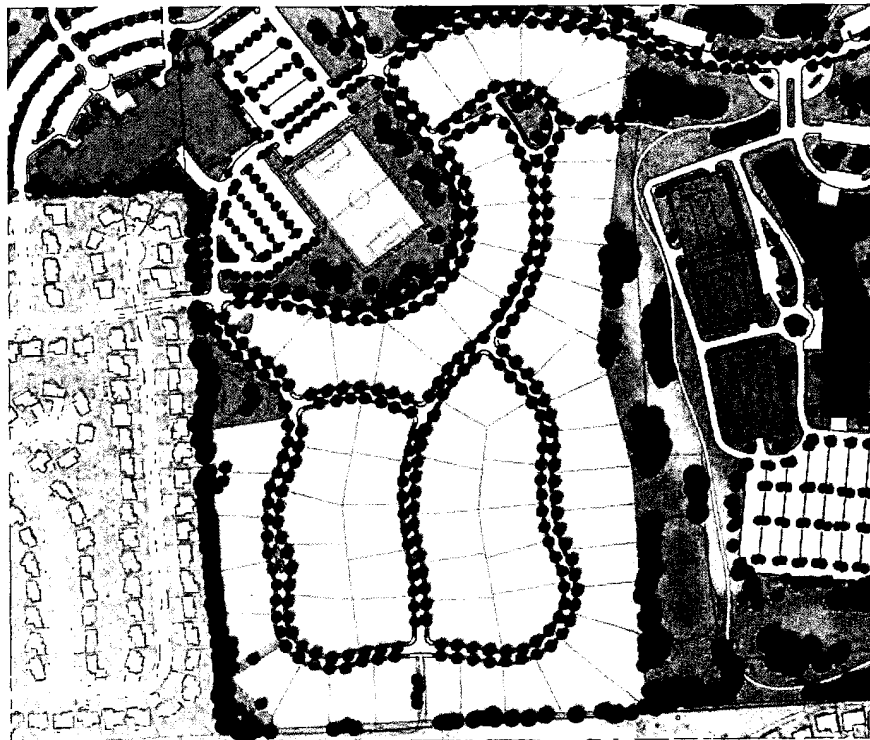

District Concept Plan



Estate homes with large manicured front yards

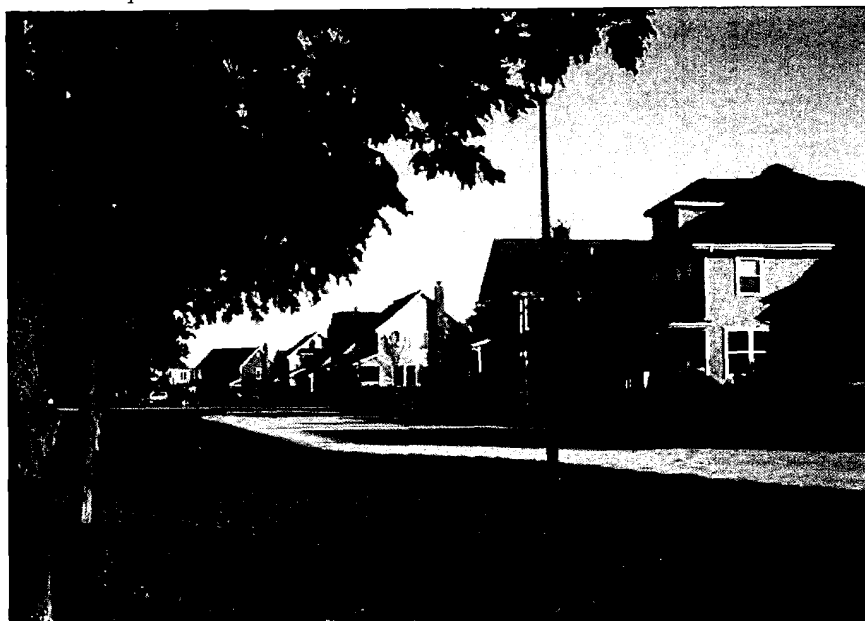

Estate homes fronting onto green



South Farm East

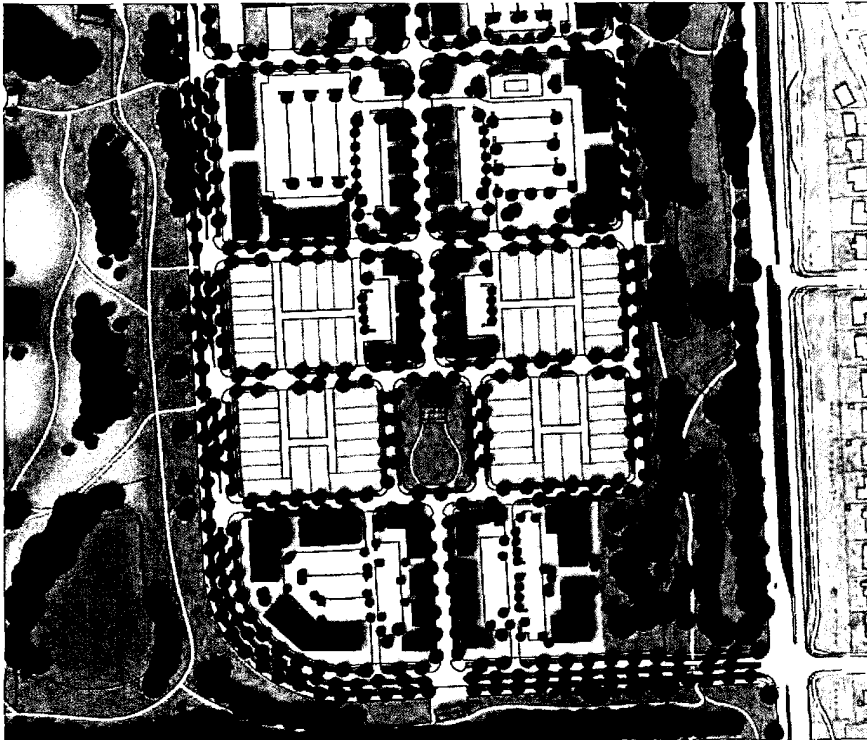

District Concept Plan



Neighborhood focal point is the community green

ESSENTIAL ELEMENTS

- » Informal front-yard plantings with direct pedestrian connection from front entrances to the public sidewalk
- » Simply-planted common open areas for apartment buildings, with good visibility between buildings
- » Abundant tree plantings and landscaped islands within apartment surface parking lots
- » Landscape rear yards of townhouses and apartments to provide relief from parking areas and alleys



Single-family and townhouse front yards

BUILDINGS AND LOTS GUIDELINES

Landscape Zones

Residential and commercial lots are typically divided into three different landscape zones: front yards, rear yards, and side yards. Each of these zones serves a different function, but should have a similar aesthetic. Front yards are the public space of a building's lot, and help a building embrace the street and welcome and/or draw visitors to the front door. As such, front yards should contain a variety of plant species and sizes, and frame views of their respective building. Rear yards are the private domain of a lot, thereby offering more flexibility and variety in terms of landscape options. Side yards separate buildings from one-another, yet also serve as the glue that ties adjacent buildings together. As such, there should be consistency in side yard landscaping in order to provide a uniform and cohesive aesthetic. Where buildings are close; however, screening will be important. The landscape design and plant palette should build off of the character of the neighborhood and the architecture of the buildings. Variety and texture in hardscape areas is encouraged, and a mix of trees, shrubs, perennials, and grasses/sedges is appropriate.



Landscaped alley within mixed-use district



Rear-yard landscape with detached garage



Front yards of small single-family homes



Retail frontage landscape zone



Typical townhouse front landscape



Multi-family frontage onto trail and greenway



Alley servicing single-family homes with rear-yard landscaping

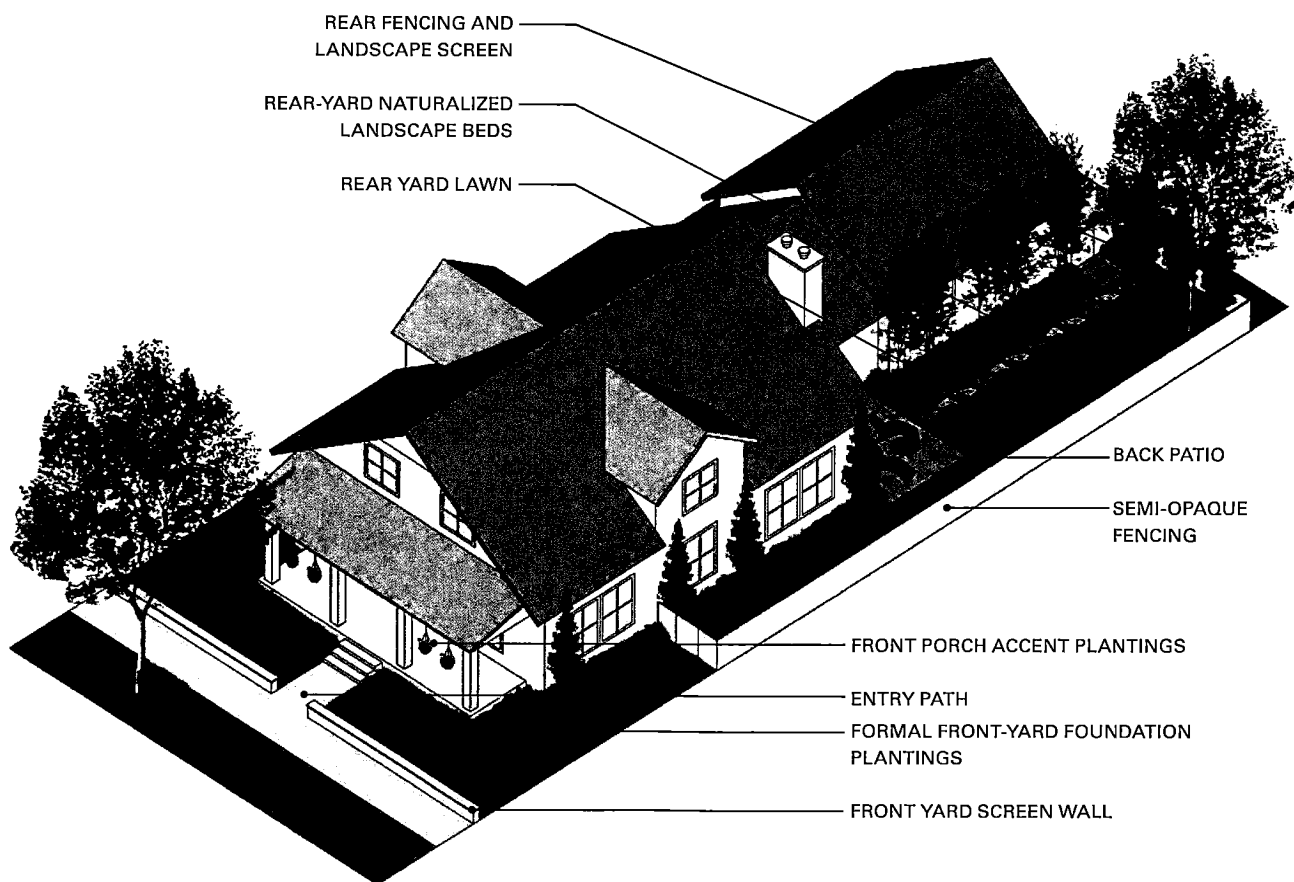

Landscape diagram

BUILDINGS AND LOTS GUIDELINES

Front Yard Elements

ESSENTIAL ELEMENTS

- » May contain low fence, walls, or hedges
- » Contain massings of native grasses and wildflowers with accent evergreen and deciduous plantings
- » Foundational plantings anchor front facades and porches
- » Distinct private lawn areas separated from public landscape
- » Well-defined paths leading from sidewalks to entryways
- » Porches and entryways raised 1½ to 2 feet above finished grade

The front yards of houses at West Farm and South Farm will be the defining landscape element of the neighborhood. Specific wall and planting requirements can be found on ensuing pages of the guidelines.

Walls, fences, and hedges ranging from 24 to 36 inches in height may define the transition from the street to the front yard. Walls shall be brick or stone. Fences shall be of a natural material such as wood or wrought iron and shall respond to the architectural character of the house. Although permitted and encouraged on all lots, low front yard retaining walls will be required on some lots for grading purposes. Front yards act as an important transition zone between the private residences and public spaces, such as sidewalks and neighborhood greens, and will have their aesthetic designed accordingly. Use of native trees, shrubs, grasses, and flowering perennials is highly encouraged.

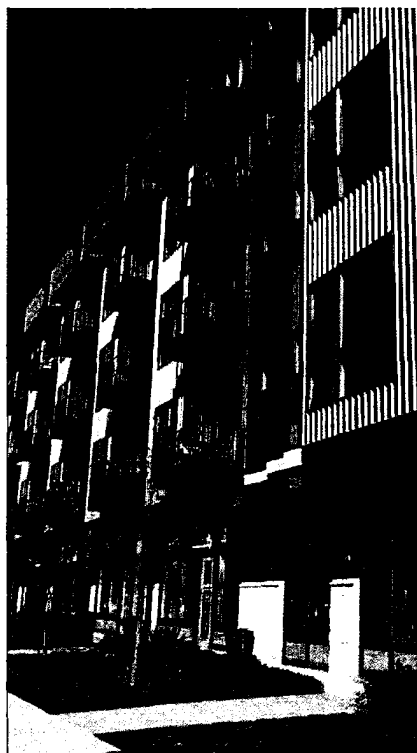

Mixed-use front-yard landscape

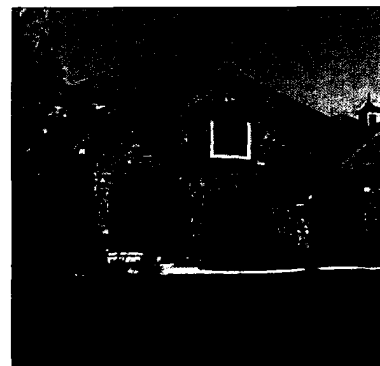

Typical front yard landscapes of single-family homes



Tree-lined street with typical single-family front yard landscaping



Front-yard landscape with comfortable setback and rise from public sidewalk

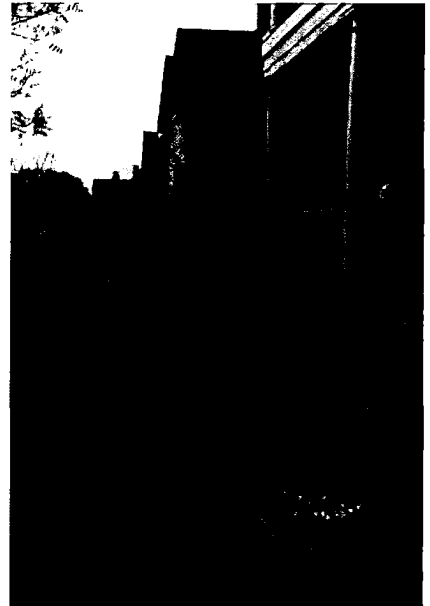

Front landscape within minimal setback



Frontage along commercial address



Landscape along front facades of townhouses



Consistent landscape and porch frontages along row of townhouses

BUILDINGS AND LOTS GUIDELINES

CHARACTERISTICS FOR SIDE-STREET AND REAR YARDS

- » Side and rear facades of buildings should include landscaped foundational beds
- » Fences, walls, and plant borders should be utilized along side and rear property lines
- » Rear yards adjacent to public open space should include transparent fencing or landscaping
- » Side-street frontages should continue design elements from front yards

Side-Street and Rear Yard Elements

Much of the West Farm and South Farm neighborhoods will have their parking areas located to the rear of lots or interiors of blocks. Many areas of West Farm and South Farm will back onto public open spaces and regional trail greenways. Thus, it will be important that the detailed landscapes of the front yards of lots be carried to the side- and rear-yards as well. Some level of transparency between rear yards and adjacent open spaces is required.

Parking areas, whether they be surface lots or alley-accessed garages, shall include ample landscaping to soften the hardscape areas. Vehicle and pedestrian access points into and out of individual lots along back or side yards shall include visual design elements emphasizing them, yet maintain sight lines for wayfinding and safety purposes.

Rear yards adjacent to public open areas shall employ heavy landscaping and or decorative fencing consistent with other public spaces. Back and side fencelines and border landscaping should abide by the guidelines noted above and on the ensuing pages.



Trees lining parking structure and service drive



Landscaped alley along rear lot line



Rear landscaping for townhouses



Side-yard landscape along public path



Side-yard landscaping and fence



Landscape feature at rear of apartments

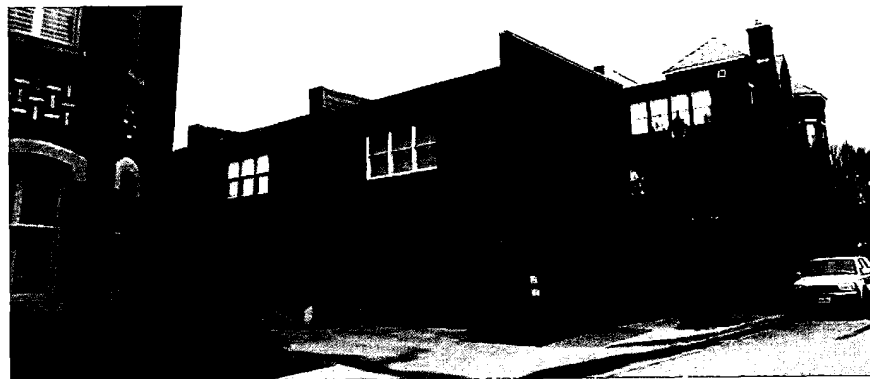

Side-street landscaping adjacent to townhouse with detached garage



Expansive native landscape to the side of corporate office building

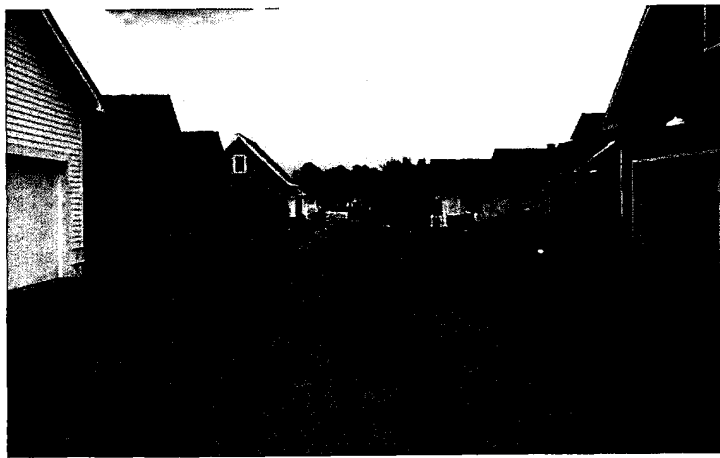

Landscape within alley for single-family lots

BUILDINGS AND LOTS GUIDELINES

Paving and Terrace Materials

ESSENTIAL ELEMENTS

- » Utilize pavement material changes to accent special areas
- » Use of permeable pavement in large hardscape areas, like surface parking lots, that reduces runoff is encouraged
- » Combine paving materials for added texture
- » Provide handicap accessible pavement in all public areas
- » Paths connecting to the regional trail network should be concrete, textured permeable pavement, or crushed aggregate

Like the landscape, the paving materials utilized in West Farm and South Farm should tie into the “Omaha Aesthetic.” Crushed stone and clay pavers are two paving types comprised of native materials. Areas of special significance or designated for special use should incorporate decorative pavement. The table below identifies the permissibility of decorative paving within the various districts.

PAVEMENT TYPE	WF M/U	WF LFR	SF M/U	WF-S	SF-W	SF-E
Decorative Concrete	P	P	P	P	P	P
Clay Pavers	P	P	P	P	P	P
Concrete Pavers	P	P	P	P	P	P
Natural Stone Pavers	CP	CP	CP	P	P	P
Crushed Aggregate	CP	NP	CP	P	P	P
Permeable Paving	CP	CP	CP	P	P	P

P = Permitted NP = Not Permitted CP = Conditionally Permitted

WF M/U = West Farm Mixed-use District WF LFR = West Farm Large Format Retail SF M/U = South Farm Mixed-use District

WF-S = West Farm South SF-W = South Farm West SF-E = South Farm East

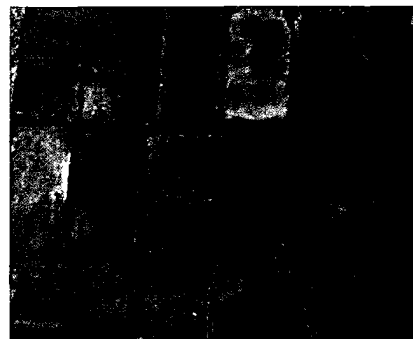
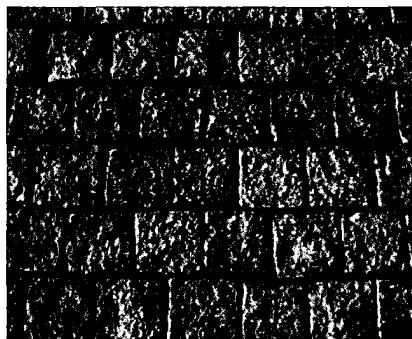
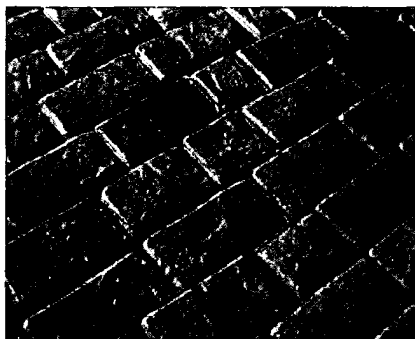

Stamped pattern in concrete (left); cobble stone paving (middle); and clay pavers (right)



Stone pavers and tree grates along an urban streetscape



Permeable concrete and crushed aggregate along urban streetscape



Colored concrete trail

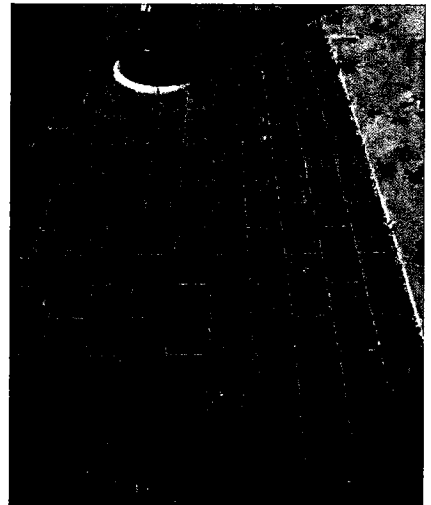

Standard gray sidewalk between allee of trees

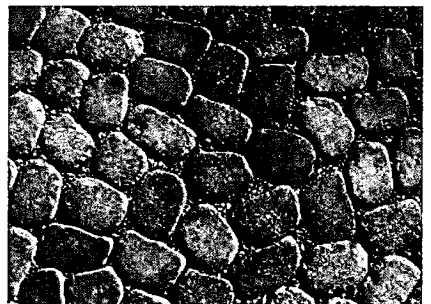

Two types of permeable pavers

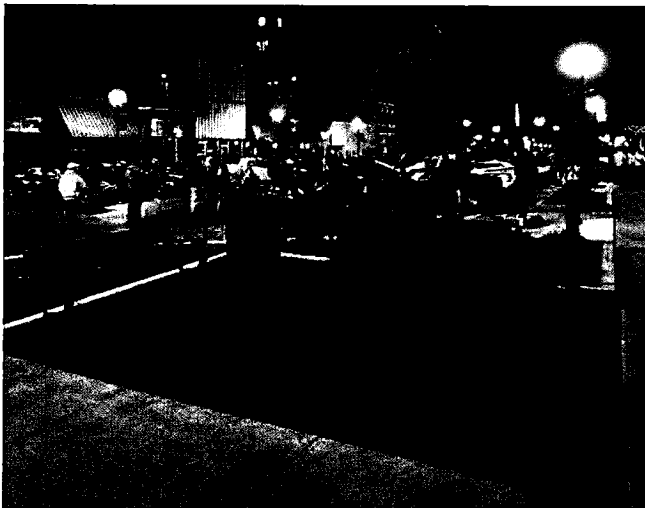

Clay pavers at streetscape node



Crushed aggregate paving at small urban park

BUILDINGS AND LOTS GUIDELINES

Fencing, Walls, and Plant Borders

ESSENTIAL ELEMENTS

- » Provide fencing, walls, or plant borders to provide a separation of public and private space as well as between adjacent lots.
- » Fence and wall materials can include wood, ornamental metal, stone, and/or brick.
- » Fence heights range from 24 inches to 72 inches.
- » Fences and screen walls can be 100% opaque up to 48 inches high and 50% opaque from 48 inches up to 72 inches high.
- » Freestanding/screen wall height varies between 18 inches to 30 inches.
- » Retaining walls shall not exceed 48 inches in height. In areas where grades dictate taller features, terraced walls will be utilized.
- » Fencing and walls on same street should utilize similar materials and design. Chain-link and board-on-board fencing will not be permitted.

Fencing, walls (retaining or screen), and plant borders provide opportunities to extend a building's architecture into the landscape. They also help define exterior spaces and guide movement. Within the West Farm and South Farm developments, fences and walls, constructed of native building materials, will provide separation between public and private spaces and where permitted, between lots. Wherever located, fences, walls, and plant borders shall not impede visibility into or out of a space, thus avoiding issues with safety and/or security.

It is intended for fences to be at least 50% transparent along public open spaces and the South Farm corporate campus so that the open space benefits of these features can be enjoyed by adjacent property owners. Mixing fence materials will add visual interest along a shared fenceline. To avoid having screen walls detract from the adjacent landscape and cause security concerns, they should be 50% opaque over 48 inches high. In addition, along a given street corridor, alley, or trail greenway, fences and walls will be constructed of consistent materials under a common design.

The existing topography will require retaining walls to be utilized throughout the development sites. These walls should be visually appealing and scaled appropriately. The impact of these vertical features should be minimized, with a height limit of 48 inches for individual walls. Terraced walls should be utilized in areas where grades require taller features.

Plant borders can consist of evergreen or deciduous shrubs or native grasses. Plant borders shall be no taller than 48 inches in height. When located along a structure or adjacent fence or wall, plant borders can help soften the vertical surface or scale-down a facade.



Manicured hedge border along front yard



Small stone wall and shrub border in a front yard landscape



Fencing along front yards of single-family homes



Shrub border with stone pillars and wood gate



Stone screen wall with decorative metal gate



Fence and shrub border at commercial frontage



Synthetic "split-rail" fencing



Stone and steel accent wall



Terraced stone retaining walls

BUILDINGS AND LOTS GUIDELINES

ESSENTIAL ELEMENTS

- » Pathways leading from parking areas to public sidewalks and regional trail network should be well-defined with landscaping
- » Visibility and sight lines should not be impeded by landscaping
- » Surface parking lots should incorporate shade trees and heavily-landscaped islands/ medians
- » Perimeter of parking areas should be heavily-planted with screen plantings where appropriate
- » Alleys should include ample landscaping along back property lines

Parking Area Landscape Elements

It will be important for the parking areas of West Farm and South Farm to be well-landscaped with native plantings consistent with the overall aesthetic of the district. Surface parking lots should include islands with heavy landscaping and canopy-forming shade trees. The perimeter of parking areas should be lined with vegetated buffers and fencing. Parking structures should be lined with a mix of plant material to soften the scale of the facade.

Outside of the Large Retail Area and a portion of the South Farm Mixed-use District, surface lots and parking structures should be located on the interior of blocks behind adjacent buildings. All parking areas should have pathways easily-accessed and well-defined by trees and understory plantings connecting to sidewalks along public streets or the regional trail system. Landscaping around parking areas should not impede visibility and sight lines that would increase the chance of pedestrian-vehicle conflicts.

The majority of residences will be alley-loaded, with private parking to the rear of lots. Alleys should include landscaping along the back property lines to soften the utilitarian nature of the alley.



Screened rear parking at mixed-use building



Example of well-landscaped surface parking lot

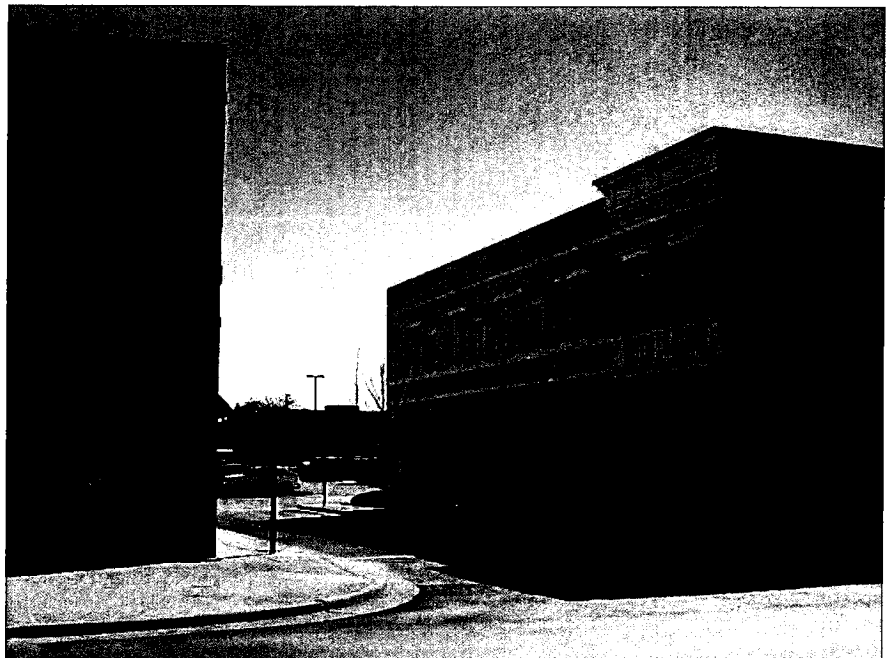

Surface parking lot located on interior of block, to the rear of mixed-use buildings



Plantings along edge of surface parking lot

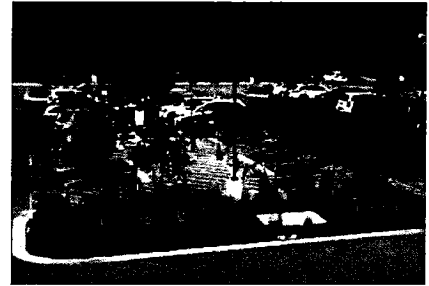

Well-landscaped island in surface parking lot

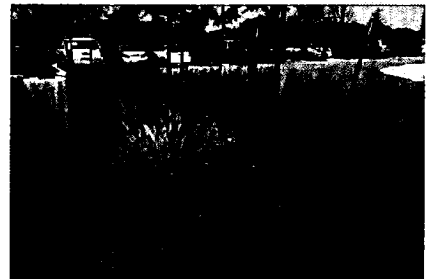

Bioswale within parking lot median



Garage softened by landscape and topography



Rear landscape between parking lot and apartment building



Landscaped pedestrian sidewalk through parking lot

BUILDINGS AND LOTS GUIDELINES

Sustainability Elements

ESSENTIAL ELEMENTS

- » Native planting material that requires little-to-no irrigation upon establishment.
- » Bioswales and detention basins located in low areas to capture and treat runoff as well as to serve as visual amenities.
- » Surface parking lots to drain to bioretention planters located in internal islands or adjacent landscape areas.
- » Runoff from building roofs and terraces captured and stored for on-site irrigation.
- » Permeable paving utilized in large hardscape areas to lessen site runoff.

A key element of the “Omaha Aesthetic” is the development of West Farm and South Farm with a landscape composition respectful of its prairie context. Sustainability will then be enhanced as the natural systems on-site will not only be represented, but enhanced. Natural drainage ways and detention areas will be protected from development. Native plant materials, which require little-to-no irrigation upon establishment, will be emphasized throughout the site.

Where required, private developments should capture and treat a portion of runoff from their individual sites. Private stormwater facilities can be tied to the large detention basins located within the developments’ public open spaces. Green infrastructure will be utilized to decrease the amount of stormwater channeled into the traditional storm sewer system. Landscape areas adjacent to, and medians within parking areas, will utilize bioswales and bioretention planters that not only provide functional value but also create aesthetic amenities for the area. It is encouraged that runoff from roofs and paved areas will be captured and stored on-site for irrigation use where applicable.



Surface parking lot with permeable pavement



Bioretention swale



Stormwater planter in confined urban space



Dry creek bed and bioswale installation

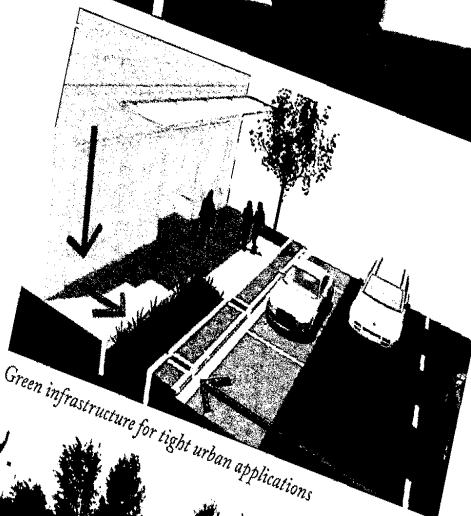
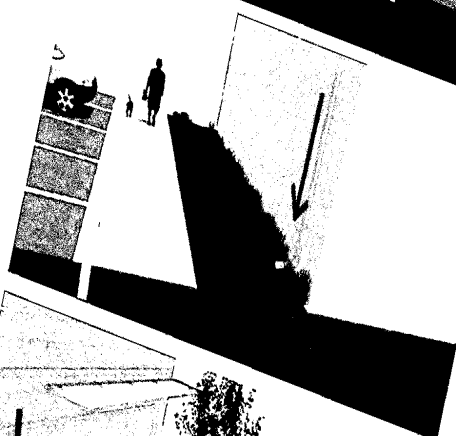
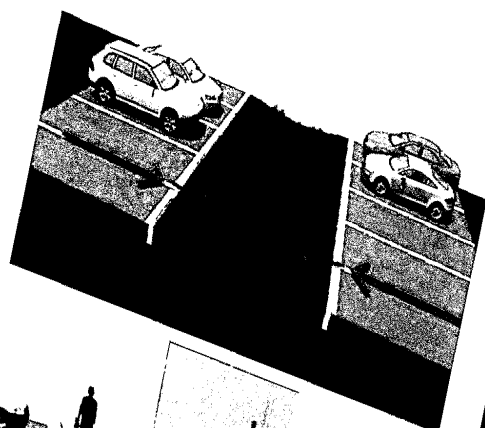

Green infrastructure for tight urban applications



Decorative check dams and stormwater chain



Bioretention pond and wetland landscape



Textured permeable pavement

LANDSCAPE PATTERNS

BUILDINGS AND LOTS GUIDELINES

ESSENTIAL ELEMENTS

- » Large, sweeping swaths of native grasses, wildflowers, and shrubs defining passive spaces
- » Manicured lawns and formal stylized planting compositions in main gatherings areas and at building and amenity area entrances with shrub borders and flowering perennials
- » Accent plantings of evergreen and flowering perennials or wildflower around native grass massings
- » Shade trees line major pedestrian paths
- » Understory shrubs and ground-covers adjacent to preserved woodland areas

Plant Palette

Native plant material will be emphasized throughout the site, helping establish West Farm and South Farm as a new neighborhood set within a prairie. The plant palette will not only define the aesthetics of West Farm and South Farm, but will serve to define the program of individual spaces. Active spaces and gathering areas will feature manicured lawns and more formal planting areas with more constructed compositions. These planting areas will feature flowering perennial beds and shrub borders to help shape spaces. Large shade trees will help define sidewalks and paths.

Passive areas designed for circulation or as backdrops for activity areas will be comprised mainly of large swaths of native grasses, wildflowers, and small shrubs. These areas will mimic the oak-savanna landscapes native to the area. Single or small groupings of hardy deciduous or evergreen trees will be placed among the grass prairies.

Perimeter woodland areas around the site will be preserved. Development adjacent to these areas will feature understory plantings common to area forest sites to help blur the line between the designed and natural woodland edge.



Layered woodland-type plantings



Native plantings along service drive



Native grass massing on steep slope



Native grass with accent evergreen plantings



Native oak savanna landscape within a corporate office campus



Native trees and grasses in a parking island



Native plantings defining a plaza



Formal native landscape at office front entrance

SAMPLE PLANT SELECTION*

Deciduous Trees

- » Bur Oak
- » White Oak
- » Swamp White Oak
- » Kentucky Coffee Tree
- » Ginkgo
- » Hybrid Elms
- » Littleleaf Linden
- » Tulip Tree
- » Sugar Maple
- » Hawthorn
- » Prairie Gold Aspen
- » Serviceberry

Evergreen Trees

- » Concolor Fir
- » Black Hills Spruce
- » Serbian Spruce
- » Colorado Blue Spruce
- » Eastern White Pine
- » Eastern Hemlock
- » Eastern Red Cedar
- » Ponderosa Pine
- » Taylor Juniper

Shrubs

- » Fragrant Sumac
- » Viburnum
- » Witchhazel
- » Chokeberry
- » Sweetspire
- » Clethra
- » Hydrangea
- » Creeping Juniper
- » Yew

Native Grasses & Perennials

- » Buffalo Grass
- » Blue Grama Grass
- » Little Bluestem
- » Prairie Dropseed
- » Big Bluestem
- » Switchgrass
- » Common Rush
- » Sedges
- » Coneflower
- » Penstemon
- » Milkweed
- » Aster
- » Liatris
- » Primrose
- » Yarrow
- » Goldenrod
- » Catmint

*not intended to be exhaustive



EXHIBIT D

MAXIMUM HEIGHTS

<u>ZONE</u>	<u>HEIGHT</u>
1	160 ft
2	160 ft
3	160 ft
4	160 ft
5	160 ft
6	200 ft
7	200 ft
8	200 ft
9	200 ft
10	200 ft
11	60 ft
12	60 ft
13	60 ft
14	60 ft
15	80 ft
16	80 ft
17	60 ft
18	110 ft
19	100 ft (except South Farm Lot 6 and South Farm Replat 1 Lot 2 shall be limited to 60 ft)