



THIS PAGE INCLUDED FOR
INDEXING
PAGE DOWN FOR BALANCE OF INSTRUMENT

REDEVELOPMENT COVENANTS

KNOW ALL MEN BY THESE PRESENTS:

That the City of Omaha, Nebraska (the "City"), ConAgra, Inc., a Delaware corporation ("ConAgra"), Omaha Development Foundation, a Nebraska non-profit corporation ("ODF"), Union Pacific Railroad Company, a Utah corporation ("UPRR"), and Opus Corporation, a Minnesota corporation, being all of the owners of the various parcels of real estate located in Douglas County, Nebraska, and more particularly described in Exhibit "A" attached hereto and incorporated by reference herein (which property shall hereinafter sometimes be referred to as the "Redevelopment Area"), have established a general plan for the improvement and development of the Redevelopment Area, and declare that all of the real estate located within the Redevelopment Area shall be subject to the covenants, conditions, reservations and restrictions set forth herein. For purposes of this Declaration, the Redevelopment Area shall be divided into five (5) separate Districts, the location and boundary of each District being shown on the Covenant Master Plan attached hereto as Exhibit "B" which shows the location and boundaries of the various Districts within the Redevelopment Area, as well as the height restrictions applicable to each District or portion of such District. Each and every one of these covenants, conditions, reservations and restrictions is for the benefit of each owner of any land within the Redevelopment Area, or any mortgage or other interest therein, and shall inure to and pass with each and every parcel, lot or site within the Redevelopment Area, and shall bind the respective successors in interest of the present owners. These covenants, conditions, reservations and restrictions are each imposed upon the lots within the Redevelopment Area, all of which are to be construed as restrictive covenants running with the title to the lots and with each and every parcel:

Misc 3184
H

1. PERMITTED USES.

Each lot within the Redevelopment Area may only be used for the use permitted by the District within which that lot lies, according to the following restrictions:

RECEIVED

FEB 23 1 41 PM '90

GEORGE J. BUGLEWICZ
REGISTER OF DEEDS
DOUGLAS COUNTY, NE

The Campus District. Except for that portion of the Campus District which will be covered by the lake (as shown on the Covenant Master Plan), the property lying within the Campus District, as shown on the Covenant Master Plan as Project No. 1 Area, Campus Expansion Site No. 1, Campus Expansion Site No. 2 and Campus Expansion Site No. 3, may be used for business office space, ancillary retail stores, laboratories and research and development facilities, pilot plants, computer facilities, heliports, helipads, storage space, parking (surface and structure), pedestrian walkways, pedestrian links (whether open or enclosed)

(L)

between buildings and parking facilities, and uses ordinarily incident to the operation of a permitted principal use.

- B. The Hotel District. The property lying within the Hotel District, as shown on the Covenant Master Plan as Private Development Site No. 1, may only be used for a full service hotel with no more than two hundred fifty (250) guest rooms (which may contain convention centers, meeting space and exercise-oriented recreation facilities), parking (surface or structure) serving only the Hotel District, pedestrian walkways and pedestrian links (whether open or enclosed) between buildings and parking facilities. Any parking lot, garage or structure built on the Hotel District shall be sized and used to accommodate the Hotel only.
- C. The UPRR District. The property lying within the UPRR District, as shown on the Covenant Master Plan as U.P.R.R. Site, may only be used for business office space, ancillary retail stores, laboratories and research and development facilities, parking (surface and structure) dispatch centers, crew management centers, pedestrian links (whether open or enclosed) between buildings and parking facilities, any other uses incident to railroad operations (except for uses involving the placement of rolling stock and track in the premises) and uses ordinarily incident to the operation of a principal permitted use.
- D. The Parking Garage District. The property lying within the Parking Garage District, as shown on the Covenant Master Plan as Parking Garage One Site, may only be used for parking, whether surface parking or multistory garage parking, including pedestrian links (whether open or enclosed) between buildings and parking facilities and the construction of a parking garage.
- E. The Business Park District. The property lying within the Business Park District, as shown on the Covenant Master Plan as Private Development Site No. 2, Private Development Site No. 3 and Private Development Site No. 4, may only be used for the construction and operation of commercial office buildings with ancillary retail services being allowed on the first floor of such structure or structures including pedestrian links (whether open or enclosed) between buildings and parking facilities, and parking (surface or structure); provided, however, any parking lot or facility in Private Development Site No. 2 and Private Development Site No. 3 shall be sized and used to accommodate those respective portions of the Business Park District only.



2. HEIGHT RESTRICTIONS.

The highest point of any building or structure, whether constructed or remodelled, located or to be located in the Redevelopment Area shall not exceed the height limits set forth in the Covenant Master Plan, as those heights apply to the respective Districts and those portions of the Business Park District designated on the Covenant Master Plan as Private Development Site No. 2, Private Development Site No. 3 and Private Development Site No. 4, respectively. Notwithstanding the foregoing, the owner of the property within the Campus District may erect one (1) free-standing tower, which shall be in addition to any other sign allowed to be erected or installed in the Campus District, with a height exceeding the maximum height established for the Campus District by an amount the owner of the Campus District may select in its sole discretion.

3. LANDSCAPING.

The permanent landscaping schemes for all Districts must provide for irrigation with automatic underground irrigation systems and may only use specimen grade trees indigenous to the Omaha, Nebraska area that have a normal and expected life of at least twenty (20) years and have a caliper measure of no less than two to three inches. In addition, the permanent landscaping scheme must include provisions for a maintenance program acceptable to the Architectural Review Committee (as defined in Section 14 below) and sufficient to insure that such site is maintained in a first class and neat and attractive condition. Such maintenance program shall include, but not be limited to, provisions for fertilization, weed and insect control, regular watering and clipping, trash and debris removal. Any landscaping scheme, having once been installed in accordance with an approved plan, shall be kept and maintained in a neat and attractive condition, which shall include keeping lawns mowed and irrigated, edges trimmed, and trees and shrubs in good condition. The approved plan for landscaping a building site may not be altered substantially without submitting a revised plan to the Architectural Review Committee for approval, which altered landscaping plan must first be approved by the Architectural Review Committee before such alterations are commenced.

4. LOADING DOCKS; ROOFTOP EQUIPMENT.

All loading docks and trash receptacles serving any building or structure on any lot must either be within the structure being built or screened from public view. No protrusions shall be allowed above the roofline of any building or structure unless approved by the Architectural Review Committee; provided, however, such protrusions will only be allowed where such protrusions are veneered with the same exterior material which is the predominant material incorporated into the facade of the



building or structure or roof or some other material compatible with the structure and acceptable to the Architectural Review Committee.

5. PARKING AND LOADING; ACCESS.

(a) The occupant of any lot shall provide or contract for parking either on-site or in public parking garages for such owner's employees, customers, clients and invitees.

(b) No parking shall be permitted on a required setback abutting a dedicated public street without the written approval of the Architectural Review Committee.

(c) No on-street parking will be permitted on public streets.

(d) All parking areas shall be covered with hard, dustfree, paved surface and shall be properly maintained at all times in a first class condition. Any surface parking lot must be landscaped with a ten-foot perimeter of sod and landscape materials, measured from the side of the sidewalk away from the street, and have at least 5% of the entire parking lot interior landscaped and sodded. Concrete curbing must be provided throughout such surface parking lot.

(e) Except to provide access to or from Lots 8 and 10, Central Park East, an Addition to the City of Omaha, as surveyed, platted and recorded in Douglas County, Nebraska, no owner of any property within the Redevelopment Area shall obtain access to their respective properties from the West or Southwest sides ConAgra Drive (as shown on the Covenant Master Plan), or make application for, install or have installed curb cuts along the West and Southwest sides of ConAgra Drive.

6. IMPROVEMENTS TO LANDSCAPE RATIO.

The impervious coverage of any lot may not exceed seventy percent (70%) of the entire area of such lot, provided the Architectural Review Committee, in its sole discretion, may grant variances from this percentage if it determines that such variance is compatible with the Covenant Master Plan and general design scheme of the Redevelopment Area.

7. SIGNS.

No billboards or advertising signs of any character shall be erected, placed, permitted or maintained on any lot or improvement except as herein expressly permitted. The owner of any lot may install a sign or signs identifying the building erected by such owner, provided, however, that the form of the sign is a low-profile "monument" type or wall sign with a size



not exceeding the greater of one square foot for each 1000 square feet of floor space in the building of which such sign identifies or 5% of the facade of such building facing the public street with the greatest frontage, is of a design and composed of materials consistent and harmonious with the building of which it identifies and is previously approved by the Architectural Review Committee as provided in Section 14 below, subject to the following restrictions:

(a) No sign shall be what is known as a walking or message sign, or what is known as an advertising sign advertising businesses or products other than to identify the business housed on the premises on which the sign is located.

(b) All signs must be compatible with and complimentary to the overall design theme of the Redevelopment Area.

(c) No sign shall have in use any flashing, pulsating or rotating light or lights.

(d) Except as provided in Section 2 above, no sign shall be located on a rooftop.

(e) No sign shall violate any ordinances of the City of Omaha, Nebraska.

8. SUBDIVISION OF DISTRICTS.

Except for the Campus District, and except for the plans and specifications for a new structure in the UPRR District (as described in Section 15.C(i) below), no more than one (1) building may be constructed in each District, except for the Business Park District, where no more than one (1) building may be constructed in each of Private Development Site No. 2, Private Development Site No. 3 and Private Development Site No. 4.

9. EXCAVATION.

No rock, gravel, clay or other material shall be excavated or removed from any property in any District for commercial purposes except strictly as necessary to prepare the site for permitted buildings and improvements.

10. NUISANCES.

No noxious weeds or underbrush shall be permitted to grow or remain upon any property in any District within the Redevelopment Area, and no refuse pile, unused motor vehicle, or private nuisance of any kind shall be allowed to be placed or to remain anywhere on any property within the Redevelopment Area. In the event that any owner of any property within the Redevelopment Area shall fail or refuse to keep such property free from noxious



weeds, underbrush, refuse piles, unused motor vehicles or any public or private nuisance of any kind, then a representative designated by the Architectural Review Committee may enter upon such property and remove the same at the expense of the owner of such property, and such entry shall not be deemed a trespass. In the event of such removal, a lien shall arise and be created in favor of such curing party and against such defaulting owner's property for the full amount of the cost of such removal and/or disposal and shall be fully chargeable to such property and said amount shall be due and payable within thirty (30) days after such defaulting owner is billed for it and the lien hereby created may be foreclosed by the curing party in like manner as any other lien against real estate.

11. CONDITION OF PROPERTY.

The owner of any property within the Redevelopment Area shall at all times keep the premises, buildings, improvements and appurtenances on such property in a safe, clean and attractive condition and comply in all respects with all government, health, fire and police requirements and regulations and these covenants, conditions and restrictions. Further, all of the owners of any property in the Redevelopment Area shall comply with the following:

(a) The premises shall at all times be kept free from excessive debris, paper, leaves, fallen branches and trash of all kinds.

(b) Outside storage of materials, equipment and products shall be prohibited except as approved by the Architectural Review Committee.

(c) Nothing shall be done on any building site that interferes with natural drainage of surface waters unless adequate alternate provisions are made therefor.

(d) Any other rules or regulations concerning conditions that are later established.

12. UTILITY LINES.

All electrical lines, communication lines, pipelines and associated utility services shall be buried underground, except temporary above-ground service shall be allowed when necessary, but only during construction of buildings and improvements.

13. REMEDIES FOR VIOLATIONS.

Upon a violation or breach of any of the covenants, conditions, reservations and restrictions set forth herein by any owner of any of the property within the Redevelopment Area, a



representative designated by the Architectural Review Committee shall have the right to proceed at law or in equity to compel compliance with the terms hereof or to prevent the violation or breach of any of them. In addition to the foregoing right, the Architectural Review Committee's designated representative shall have the right, whenever there shall have been built on any property any structure which is in violation of these restrictions, to enter upon the property where the violation of any of the covenants, conditions, reservations and restrictions exist and summarily abate or remove the same at the expense of the owner, and any such entry and abatement or removal shall not be deemed a trespass. The cost of such abatement shall be a lien against that owner's property and may be foreclosed in like manner as provided in Section 10, above. The failure promptly to enforce any of the covenants, conditions, reservations and restrictions contained herein shall not bar their enforcement.

14. APPROVAL OF PLANS.

There is hereby established the Architectural Review Committee, which shall consist of three members, one member of which shall be selected by the Mayor of the City with the approval of the Omaha City Council, one member of which shall be selected by ConAgra and one member of which shall be selected by ODF.

At such time as ODF conveys title to the entire Business Park District to any party or parties, the member of the Architectural Review Committee selected by ODF shall be replaced by a member selected by the owner or owners of at least 51% of the square footage of rentable area (BOMA) of buildings in the Business Park District; provided, however, the member of the Architectural Review Committee selected by ODF shall retain his or her position until such time as the owner or owners of at least 51% of the square footage of rentable area (BOMA) of buildings in the Business Park District provides ODF with written notice identifying the new member of the Architectural Review Committee selected by such party or parties.

At such time as ConAgra, or any wholly owned subsidiary of ConAgra, is no longer the owner or tenant of the Campus District, the member of the Architectural Review Committee selected by ConAgra will be replaced with a member selected by the succeeding owner of the Campus District, and thereafter, each successive owner of the Campus District shall be entitled to select one member of the Architectural Review Committee to replace the member selected by the preceding owner of the Campus District.

Before commencing the construction, installation or alteration of any building, enclosure, landscaping, fence, parking facility, parking garage, sign, light pole, fence or fixture, or any other structure or temporary or permanent



improvements on or to any property or portion thereof in any District within the Redevelopment Area, the property owner shall first submit site plans, grading and utility plans, landscaping plans, sign and sign allocation plans, floor plans and building elevations and materials plans to the Architectural Review Committee for its written approval. The Architectural Review Committee will be guided by the performance Standards set forth in Section 15 below, the Covenant Master Plan, and Sections 1, 2, 3, 4, 6, and 7 above. Except as set forth below, any site plans, grading and utility plans, landscaping plans, sign and sign allocation plans, floor plans and building elevations or materials plans submitted to the Architectural Review Committee shall not be deemed approved unless approval is granted by at least two (2) members of the Architectural Review Committee. In the event that the Architectural Review Committee, or its designated representative, shall fail to approve or disapprove the site plans, grading and utility plans, landscaping plans, sign and sign allocation plans, floor plans and building elevations or materials plans within ten (10) days after they have been received by the Architectural Review Committee, the approval will not be required and this covenant will be deemed to have been complied with. Disapproval shall be deemed to have occurred if two (2) members of the Architectural Review Committee vote against a plan or proposal. Notwithstanding the foregoing, the execution of this Declaration by all parties hereto shall constitute approval by the Architectural Review Committee of UPRR's plans and specifications attached hereto as Exhibit "C" for the construction and renovation to occur in the UPRR District, and shall constitute approval by the Architectural Review Committee of the buildings, structures and landscaping being designed, constructed and installed for Phases I and II of the Campus District by the Campus District owner; provided, however, UPRR shall still be required to comply with all other provisions of this Declaration, including, but not limited to, obtaining the Architectural Review Committee's approval to any amendments, modifications or waivers to those plans and specifications attached hereto as Exhibit "C".

15. PERFORMANCE STANDARDS.

The Architectural Review Committee shall approve or disapprove site plans, grading and utility plans, landscaping plans, sign and sign allocation plans, floor plans and building elevations and materials plans for construction based on the conformance of such site plans, grading and utility plans, landscaping plans, floor plans and building elevations and materials plans with the performance standards set forth below, the Covenant Master Plan, and Sections 2, 3, 4, 5, 6 and 7 above, which shall apply in accordance with the District for which the relevant lot or lots lie within.



A. The Campus District.

- (i) Design. All buildings, structures, improvements, enclosures, landscaping, parking facilities, roads, roadways, streets, light poles, fences and any other structures shall be of a design that shall be in harmony with and shall be consistent with a planned office park environment characterized by extensive landscaping, low-rise buildings, and unified graphics and materials. The exterior materials for all buildings, including roofing materials, shall harmonize with the landscaping of the Redevelopment Area as a whole.
- (ii) Materials. The exterior of any structure may only be composed of brick, natural stone or architectural pre-cast concrete with glass, but predominantly glass-skinned exteriors shall be excluded.
- (iii) Setbacks. Except with regard to the construction of parking facilities (whether surface or structure), which parking facilities shall not be subject to any setback requirements, all portions of buildings and structures above grade must have setbacks of at least twenty-five (25) feet from the interior lines of all public street rights-of-way. Any lot line not abutting a public street right-of-way shall not be subject to any setback requirements.

B. The Hotel District.

- (i) Design. All buildings, structures, improvements, enclosures, landscaping, parking facilities, roads, roadways, streets, light poles, fences and other structures shall be of a design that shall be in harmony with and shall be consistent with a planned office park environment characterized by extensive landscaping, low-rise buildings and unified graphics and materials, and more particularly, shall be in harmony with and shall be consistent with the design of the structures and improvements located in the Campus District. The exterior materials for all buildings, including roofing materials, shall harmonize with the materials, colors and landscaping as found in the Campus District. Notwithstanding the foregoing, the design of the Western face of any



building or structure in the Hotel District shall harmonize with the Old Market area in the City of Omaha, Nebraska.

- (ii) Materials. The exterior of any structure may only be composed of brick, natural stone or architectural pre-cast concrete with glass, but predominantly glass-skinned exteriors shall be excluded.
- (iii) Setbacks. All portions of buildings and structures above grade must have setbacks of at least thirty-five (35) feet from the Eastern lot line, one hundred thirty (130) feet from the Northern lot line and twenty (20) feet from the Southern lot line.
- (iv) Pedestrian Access. The owner of the Hotel District shall provide an easement across the Hotel District for public pedestrian and handicapped access from the intersection of 10th and Howard Streets to the northeast corner of the Hotel District site, which shall be available to the general public during reasonable hours for the purpose of passing between the "Old Market" area and the Park. Said easement shall be maintained by the owners of the Hotel District. The exact location of said easement shall be determined by the Hotel District owners.

C. The UPRR District.

- (i) New Construction; Remodelling; Materials. The existing building located in the UPRR District shall be reconfigured and remodelled, and the proposed new building for the UPRR District, as proposed by UPRR, shall be constructed, in accordance with those plans and specifications attached hereto as Exhibit "C".
- (ii) Setbacks. Portions of all buildings and structures above grade shall be set back from all lot lines in conformance with the setback requirements for the UPRR District as shown on Exhibit "C" attached hereto.
- (iii) Landscaping. On or before August 1, 1989, there shall be planted along the entire side of the UPRR District abutting ConAgra Drive (as defined in Section 5(e) above) mature specimen grade evergreen trees with heights of no less than thirty-five (35) feet. Such trees shall be



planted at intervals of no less than forty (40) feet apart, and shall at all times be maintained in a healthy condition and immediately be replaced in the event of death, destruction or removal of any tree.

D. The Parking Garage District.

- (i) Design. All buildings, structures, improvements, enclosures, landscaping, parking facilities, roads, roadways, streets, light poles, fences and any other structures shall be of a design that shall be in harmony with and shall be consistent with a planned office park environment characterized by extensive landscaping, low-rise buildings, and unified graphics and materials, and more particularly shall be in harmony with and shall be consistent with the design of the structures and improvements located in the Campus District. The exterior materials for all buildings, including roofing materials, shall harmonize with the materials, colors and landscaping as found in the Campus District.
- (ii) Materials. The exterior of any structure may only be composed of brick, natural stone or architectural pre-cast concrete with glass, but predominantly glass-skinned exteriors shall be excluded.
- (iii) Setbacks. Except for the side of the Parking Garage District facing Leavenworth Street, which side shall be allowed a zero (0) foot setback from the Leavenworth Street right-of-way, and except for the side of the Parking Garage District facing Jones Street, which side shall have a minimum twenty-five (25) foot setback from the Jones Street right-of-way, all portions of building and structures above grade located in the Parking Garage District must have setbacks of at least ten (10) feet from all lot lines.

E. The Business Park District.

- (i) Design. All buildings, structures, improvements, enclosures, landscaping, parking facilities, roads, roadways, streets, light poles, fences and any other structures shall be of a design that shall be in harmony with and shall be consistent with a planned office park environment characterized by extensive landscaping, low-rise buildings, and unified graphics and materials,



and more particularly, shall be in harmony with and shall be consistent with the design of the structures and improvements located in the Campus District. The exterior materials for all buildings, including roofing materials, shall harmonize with the materials, colors and landscaping as found in the Campus District.

(ii) Materials. The exterior of any structure may only be composed of brick, natural stone or architectural pre-cast concrete with glass, but predominantly glass-skinned exteriors shall be excluded.

(iii) Setbacks. Except for the sides of the Business Park District facing 9th Street, 10th Street or Leavenworth Street, which sides shall be allowed a zero (0) foot setback from such street rights-of-way, and except for the Northern side of Private Development Site No. 2, which side shall be allowed a twenty (20) foot setback from the Northern lot line of Private Development Site No. 2, all portions of buildings and structures above grade within the business Park District must have setbacks of at least thirty-five (35) feet from all lot lines.

16. WAIVER, MODIFICATION OR AMENDMENT OF COVENANTS, CONDITIONS, RESERVATIONS AND RESTRICTIONS BY ARCHITECTURAL REVIEW COMMITTEE.

The owner of any lot within the Redevelopment Area may petition the Architectural Review Committee to waive compliance with, grant a variance to, modify or amend the Covenant Master Plan or any of the covenants, conditions, reservations or restrictions set forth in Sections 1, 2, 3, 4, 5, 6, 7, 8, and 15 of this Declaration, and the Architectural Review Committee is hereby given the power to waive any such covenants, conditions, reservations or restrictions upon such request. The Architectural Review Committee, in its sole and absolute discretion, may decide to waive, vary, modify or amend the Covenant Master Plan and/or such covenants, conditions, reservations or restrictions, but such waiver, variance, modification or amendment shall only be effective upon the consent of the member of the Architectural Review Committee selected by ConAgra, or its successors, and one other member of the Architectural Review Committee. Notwithstanding any other provision contained herein, if the Architectural Review Committee shall fail to approve or disapprove any such requests for waiver, variance, modification or amendment within thirty (30) days after such request has been submitted to the Architectural Review



Committee, such request shall be deemed conclusively to have been disapproved unless or until the Architectural Review Committee takes further action on the same, if ever.

17. TERM AND EXTENSIONS.

The Covenant Master Plan and each covenant, condition, reservation and restriction contained in this instrument shall continue in effect indefinitely until terminated as provided below as of a "Termination Date", the first of which shall be on July 31, 2019. At any time within one (1) year prior to July 31, 2019, and each thirty (30) year period thereafter (each such date being referred to herein as a "Termination Date") the then owners of the majority of the area in square feet in the Redevelopment Area may by written declaration, signed and acknowledged by them and duly recorded with the Register of Deeds for Douglas County, Nebraska, terminate the covenants, conditions, reservations and restrictions herein effective as of the next Termination Date and, failing such termination, the Covenant Master Plan and these covenants, conditions, reservations and restrictions shall automatically be renewed and extended for successive periods of thirty (30) additional years, and this right to terminate at the end of each such thirty (30) year period by the then owners shall exist until the owners of the majority of the area in square feet within the Redevelopment Area affirmatively vote to so terminate them.

18. INTEREST.

Whenever and as often as one party shall not have paid any sum payable hereunder to another party, or to the Architectural Review Committee, within five (5) days of the due date, such delinquent party shall pay interest on such amount from the due date to the date such payment is received by the party entitled thereto, at an interest rate equal to two percent (2%) above the prime rate for the First National Bank of Omaha in effect as of the date of such payment.

19. ESTOPPEL CERTIFICATE.

Each owner of any property within the Redevelopment Area agrees that upon written request (which shall not be more frequent than three (3) times during any calendar year by a single requester) of any other party, it will issue to a prospective mortgagee or successor of such other owner or to such other party, an estoppel certificate stating to the best of the issuer's knowledge that as of such date:

(a) whether the owner to whom the request has been directed knows of any default by the requesting party under this Declaration, and if there are known defaults, specifying the nature thereof;



(b) whether this Declaration has been modified or amended in any way by the requested owner (and if it has, then stating the nature thereof);

(c) whether this Declaration is in full force and effect;

Such statement shall act as a waiver of any claim by the owner furnishing it to the extent such claim is based upon facts contrary to those asserted in the statement and to the extent the claim is asserted against a bona fide encumbrancer or purchaser for value without knowledge of facts to the contrary of those contained in the statement, and who has acted in reasonable reliance upon the statement; however, such statement shall in no event subject the owner furnishing it to any liability whatsoever, notwithstanding the negligent or otherwise inadvertent failure of such owner to disclose correct and/or relevant information.

20. NOTICES.

All notices, demands, statements, and requests (collectively the "notice") required or permitted to be given under this Declaration must be in writing and shall be deemed to have been properly given or served as of the date hereinafter specified: (i) on the date of personal service upon the person to whom the notice is addressed or if such person is not available the date such notice is left at the address of the person to whom it is directed, (ii) on the date the notice is postmarked by the United States Post Office, provided it is sent prepaid, registered or certified mail, return receipt requested, and (iii) on the date the notice is delivered by a courier service (including Federal Express, express Mail, Emery or similar operation) to the address of the person to whom it is directed, provided it is sent prepaid, return receipt requested. The addresses of the signatories to this Declaration are set forth below.

City of Omaha	c/o Ken Bunger, Esq. City Attorney Omaha/Douglas Civic Center 1819 Farnam Street Omaha, NE 68183
---------------	--

ConAgra, Inc.	ConAgra Center One Central Park Plaza Omaha, NE 68102 Attention: Controller
---------------	--



And:

Bruce C. Rohde
McGrath, North, Mullin
& Kratz, P.C.
Suite 1100
One Central Park Plaza
Omaha, NE 68102

Omaha Development Foundation 1301 Harney
Omaha, NE 68102
Attention: Michael Wiese

Union Pacific Railroad Company 1416 Dodge Street
Omaha, NE 68179
Attention: General Counsel

21. DECLARATION SHALL CONTINUE NOTWITHSTANDING BREACH.

It is expressly agreed that no breach of this Declaration shall (i) entitle any party to cancel, rescind or, otherwise terminate this Declaration, or (ii) defeat or render invalid the lien of any mortgage or deed of trust made in good faith and for value as to any part of the Redevelopment Area. However, such limitation shall not affect in any manner any other rights or remedies which a party may have hereunder by reason of any such breach.

22. APPROVAL RIGHTS.

Unless provision is made for a specific time period, approval shall be given or withheld within ten (10) days of the receipt of the request for approval. Except as otherwise provided in this Declaration, if a disapproval is not given within the required time period, the requested party shall be deemed to have given its approval. If a party shall disapprove, the reasons therefor shall be stated. Except with respect to any approval or disapproval given by lapse of time, all approvals and disapprovals shall be in writing.

23. LIEN FOR EXPENSES.

(a) The liens provided for in Sections 10 and 13 above shall only be effective when filed for record by the designated representative of the Architectural Review Committee claiming a lien against the defaulting owner in the Office of the Register of Deeds for Douglas County, Nebraska, signed and acknowledged, which shall contain at least:



- (i) A statement of the unpaid amount of costs and expenses;
- (ii) A description sufficient for identification of that portion of the property of the defaulting owner which is the subject of the lien; and
- (iii) The name of the owner or reputed owner of the property which is the subject of the alleged lien.

(b) The lien, when so established against the real property described in the lien, shall be prior and superior to any right, title, interest, lien or claim which may be or has been acquired or attached to such real property after the time of filing the lien. The lien shall be for the use and benefit of the designated representative of the Architectural Review Committee claiming the lien pursuant to Sections 10 or 13 above, and may be enforced and foreclosed in a suit or action brought in any court of competent jurisdiction.

24. EFFECT OF SALE BY OWNER.

If any owner of any property in the Redevelopment Area sells its property, then after the date of sale, such owner shall have no further obligation under this Declaration with respect to such property sold; provided, however, the selling owner shall remain liable for obligations incurred prior to said sale.

25. DEFAULT IN PAYMENT OF EXPENSES.

Notwithstanding any of the provisions of this Declaration, a breach of any of the conditions and covenants contained herein shall not defeat, affect or render invalid the lien of any mortgage or deed of trust made in good faith and for value, but such conditions and covenants shall be binding and effective against any owner of any property or any portion thereof whose title thereto is acquired by foreclosure, trustee's sale or otherwise.

26. RULE AGAINST PERPETUITIES.

In the event the provisions hereunder are declared void by a court of competent jurisdiction by reason of the period of time herein stated for which the same shall be effective being contrary to applicable law or prohibited by the "rule against perpetuities" or any similar law, then in that event only the term hereof shall be reduced to the maximum period of time which does not violate such law or the rule against perpetuities as set forth in the laws of the State of Nebraska.



27. WAIVER.

No delay or omission on the part of the Architectural Review Committee or the owners of any lots in the Redevelopment Area in exercising any rights, power or remedy herein provided, in the event of any breach of the covenants, conditions, reservations, or restrictions herein contained, shall be construed as a waiver thereof or acquiescence therein, and no right of action shall accrue nor shall any action be brought or maintained by anyone whatsoever against the Architectural Review Committee for or on account of the Architectural Review Committee's failure to bring any action on account of any breach of these covenants, conditions, reservations or restrictions.

28. SEVERABILITY.

In the event any one or more of the foregoing covenants, conditions, reservations or restrictions is declared for any reason by a court of competent jurisdiction, to be null and void, the judgment or decree shall not in any manner whatsoever affect, modify, change, abrogate or nullify any of the other covenants, conditions, reservations and restrictions not specifically declared to be void or unenforceable, but all of the remaining covenants, conditions, reservations and restrictions not expressly held to be void or unenforceable shall continue unimpaired and in full force and effect.

29. BENEFICIARIES.

These covenants, conditions, reservations and restrictions are made for the benefit of any and all persons who may now own, or who may in the future own, property in the Redevelopment Area. Such persons are specifically given the right to enforce these restrictions and covenants by injunction or other legal or equitable procedure, and to recover damages resulting from any violation thereof, including the cost of enforcing the same, which costs shall include court costs and reasonable attorneys fees as permitted by law.

IN WITNESS WHEREOF, the City of Omaha, Nebraska, ConAgra, Inc., Omaha Development Foundation, and Union Pacific Railroad Company, have caused these presents to be executed at Omaha, Douglas County, Nebraska, this 10th day of August, 1989.



THE CITY OF OMAHA, NEBRASKA

By: [Signature] 8/10/89
Title: MAYOR

CONAGRA, INC., a Delaware Corporation

By: [Signature]
Title: Vice President Controller

OMAHA DEVELOPMENT FOUNDATION, a Nebraska nonprofit corporation

By: [Signature]
Title: Executive Director

UNION PACIFIC RAILROAD COMPANY, a Utah corporation

By: [Signature]
Title: Exec. Vice President-Operation

OPUS CORPORATION, a Minnesota corporation

By: [Signature]
Title: President

App'd as to form:
[Signature]
Asst City Atty



STATE OF NEBRASKA)
) ss.
COUNTY OF DOUGLAS)

The foregoing instrument was acknowledged before me on August 10, 1989, by P.T. MORGAN and BUSTER GEMM, who is MAYOR and DEPT. CITY OF the CITY OF OMAHA, NEBRASKA, and acknowledged said Declaration on behalf of the CITY OF OMAHA, NEBRASKA.



Elaine M. Sheets
Notary Public

STATE OF NEBRASKA)
) ss.
COUNTY OF DOUGLAS)

The foregoing instrument was acknowledged before me on August 22, 1989, by D.T. Peters, who is Vice President/Controller of CONAGRA, INC., and acknowledged said Declaration on behalf of CONAGRA, INC.

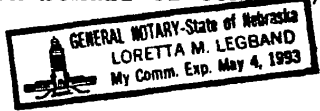

Loretta M. Legband
Notary Public

x STATE OF NEBRASKA)
) ss.
COUNTY OF DOUGLAS)

The foregoing instrument was acknowledged before me on August 22, 1989, by Michael C. Wiese, who is Executive Director of the OMAHA DEVELOPMENT FOUNDATION, and acknowledged said Declaration on behalf of the OMAHA DEVELOPMENT FOUNDATION.

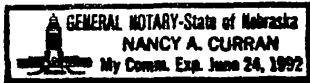

Nancy A. Curran
Notary Public



STATE OF NEBRASKA)
) ss.
COUNTY OF DOUGLAS)

BOOK 914 PAGE 512

The foregoing instrument was acknowledged before me on February 22, 1990, by R. K. Davidson, who is Exec. VP-Operation of the UNION PACIFIC RAILROAD COMPANY, and acknowledged said Declaration on behalf of the UNION PACIFIC RAILROAD COMPANY.



Milli M. Scheer

Notary Public

STATE OF MINNESOTA)
) ss.
COUNTY OF HENNEPIN)

The foregoing instrument was acknowledged before me on September 21, 1989, by Gene Haugland, who is President of the OPUS CORPORATION, and acknowledged said Declaration on behalf of the OPUS CORPORATION.

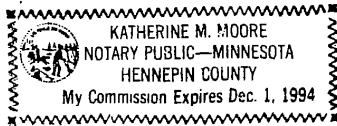

Katherine M. Moore

Notary Public



EXHIBIT "A"

[Legal Description of Redevelopment Area]

Comp 23-6170.75

Lots 1-20, Central Park East, an Addition to the City of Omaha, together with the South half of Block 177, Original City of Omaha, as surveyed, plated and recorded in Douglas County, Nebraska, and the entire alley abutting the North line of said South half of said Block 177.

10-1 05-20000

(L)

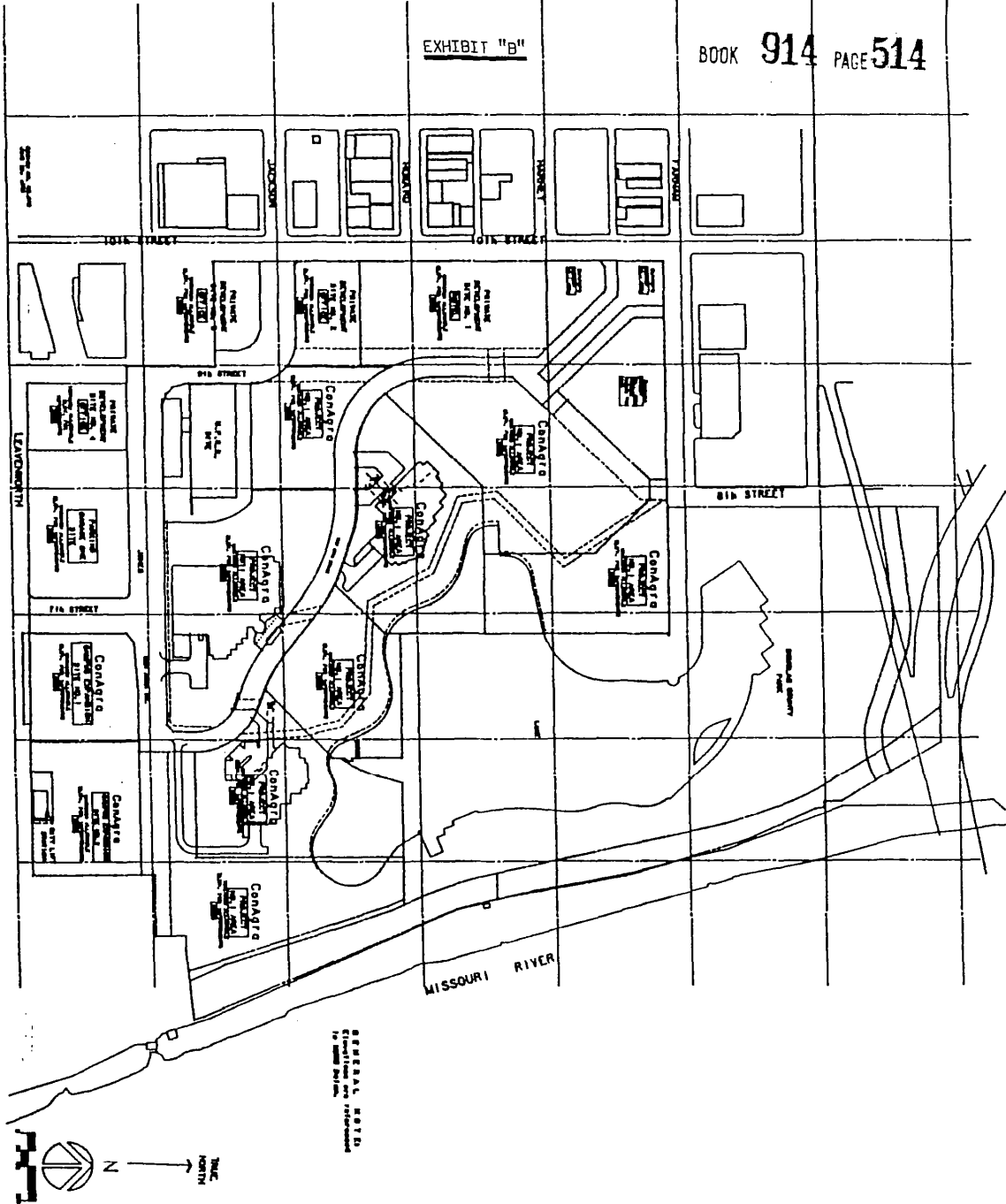

GENERAL NOTE:
 Dimensions are referenced
 to 1988 Project.

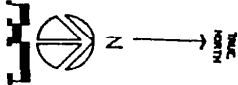

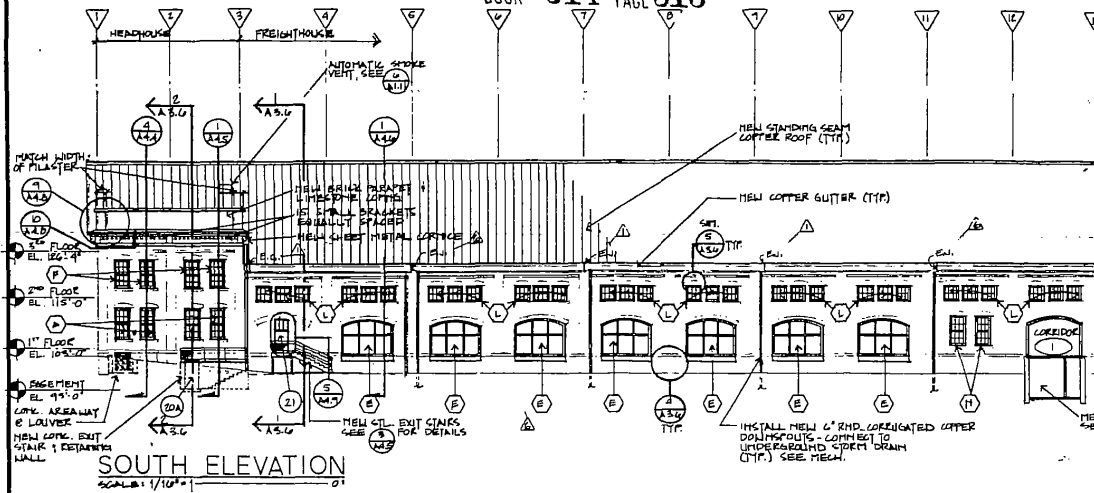

SOUTH ELEVATION
SCALE: 1/16"=1'-0"

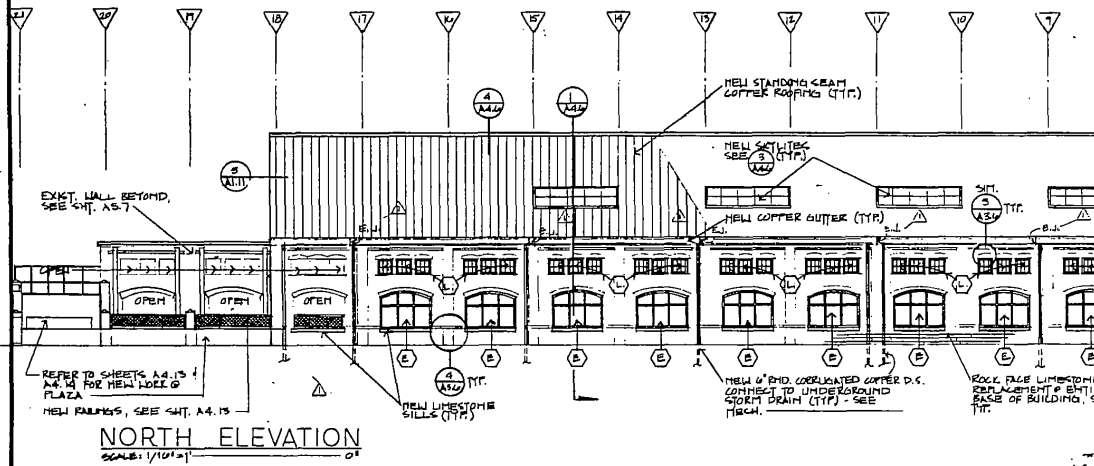

NORTH ELEVATION
SCALE: 1/16"=1'-0"

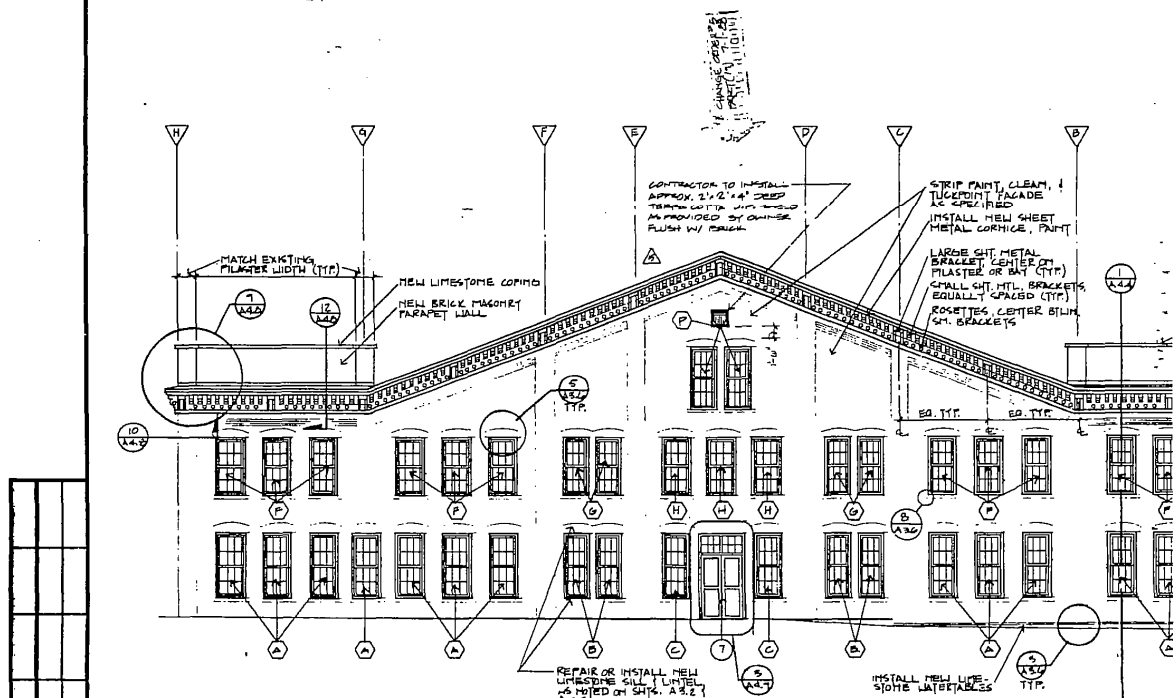

WEST ELEVATION
SCALE: 1/8"=1'-0"

ITEM NO. 16-97 SHEET AS.1
 a. East
 113'
 b. Date

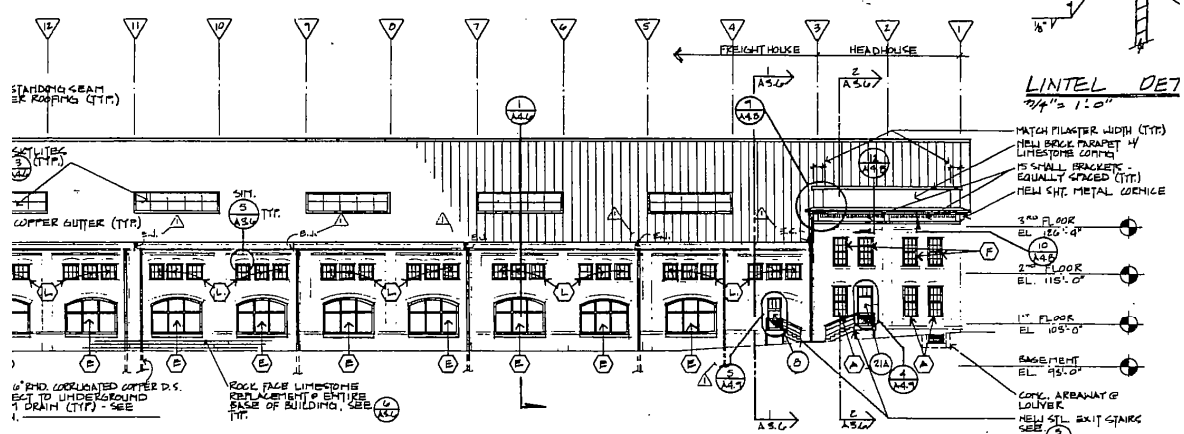
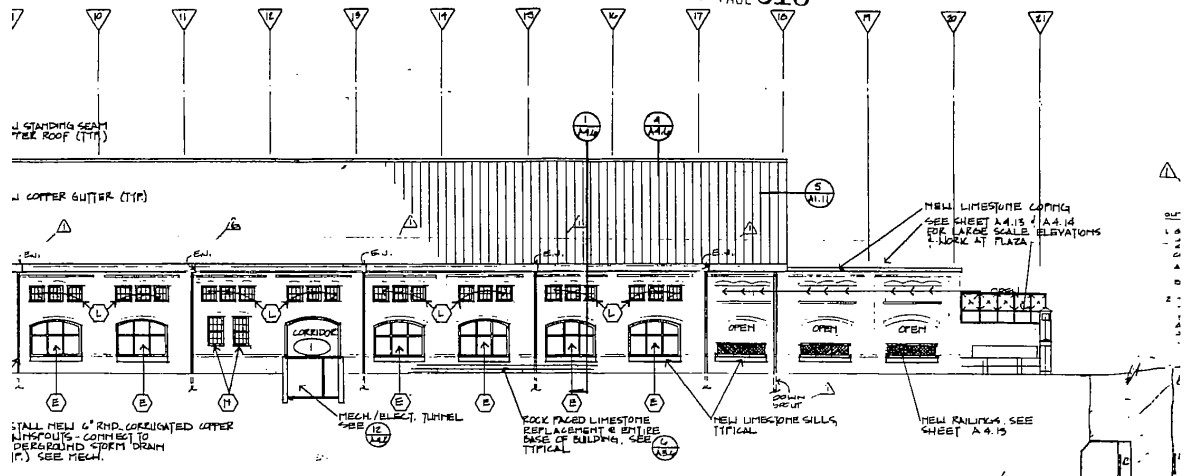

ITEM NO. 36-14 SHEET A3.4 - ELEVATION - FREIGHTHOUSE/HEADHOUSE
 a. See partial sheet A3.4a ISSUED with this A
 b. Detail 1/A3.4., delete "Lintel" - see substitute "Lintel" - see Detail 2/A3.4."

ITEM NO. 26-34 SHEET A3.4 - ELEVATIONS - FREIGHTHOUSE/HEADHOUSE
 a. Detail 1/A1.7. Add notes "SEE DETAIL 7/ AND FOOTING REINFORCING."

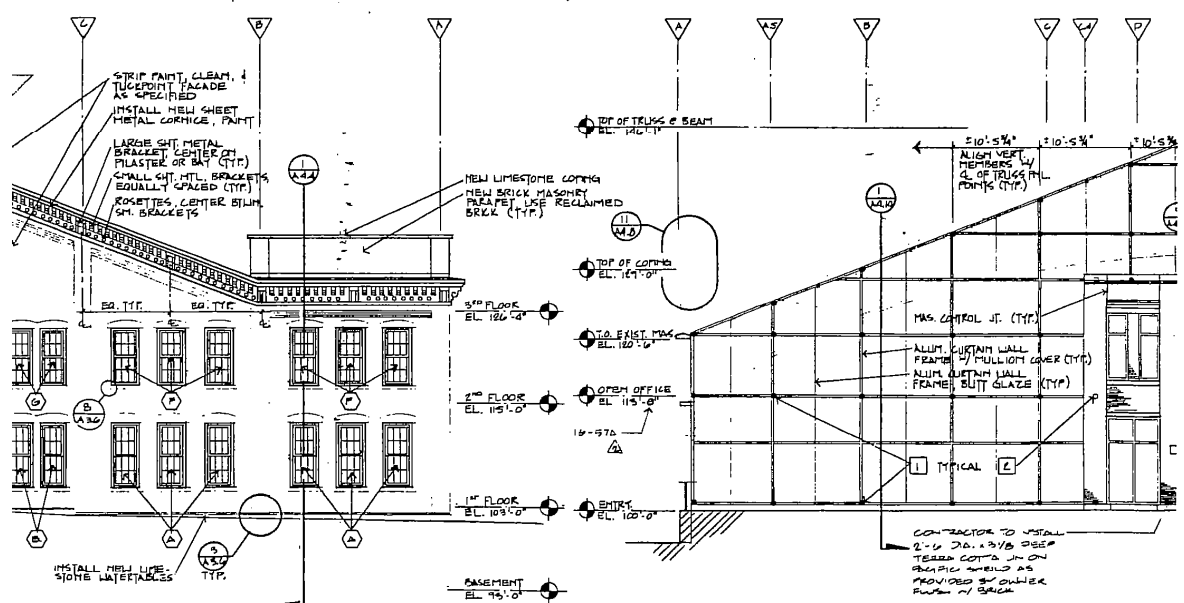

EAST ELEVATION
 SCALE: 1/8" = 1'-0"

ITEM NO. 16-57 SHEET A3.4 - ELEVATIONS - FREIGHTHOUSE/HEADHOUSE
 a. East elevation, open office level elevation shall be 113'-8".
 b. Detail 1/A3.4.
 1) Delete 5'-0" x 3'-4" louver size.
 2) Add membrane waterproofing and 2" rigid insulation to existing foundation wall.

EXHIBIT C

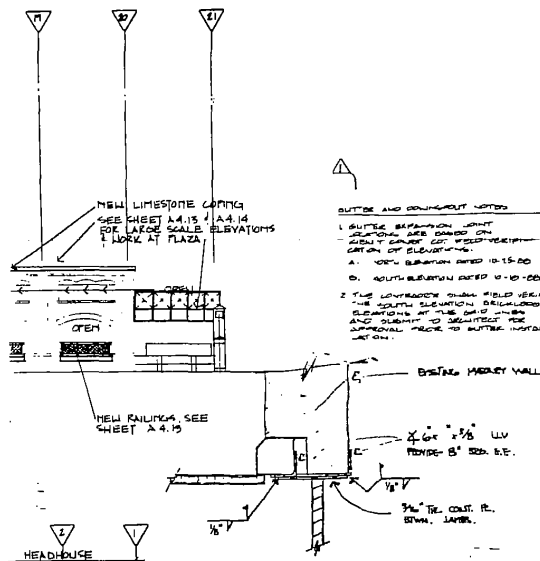

NEW CONSTRUCTION ELEVATION NOTES

1. All elements shown in solid lines indicate new construction as noted.
2. Building elements shown in half-tone or in light lines are existing.
3. Refer to existing building elevations on drawings A3.2 and A3.3 for extent of stone repairs, replacement, and patching.
4. Refer to existing building elevations on drawings A3.2 and A3.3 for extent of brick masonry touchup and repair.

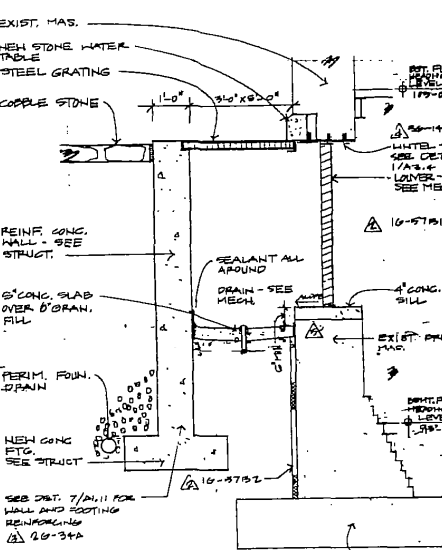
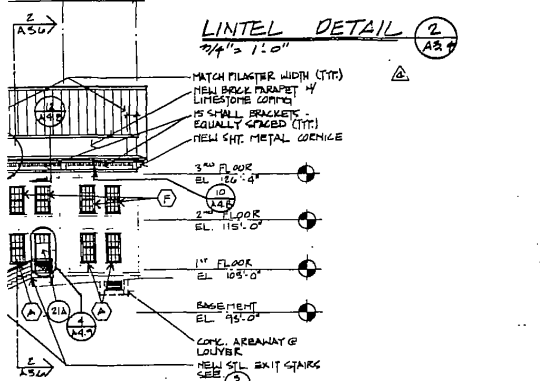

0. 30-14 SHEET A3.4 - ELEVATION - FREIGHTHOUSE/HEADHOUSE
 a. See partial sheet A3.4 ISSUED with this Addendum.
 b. Detail 1/A3.4., delete "Lintel" - see Struct., and substitute "Lintel" - see Detail 2/A3.4.

10. 20-34 SHEET A3.4 - ELEVATIONS - FREIGHTHOUSE/HEADHOUSE
 a. Detail 1/A1.7. Add note: "SEE DETAIL 7/A1.11 FOR WALL AND FOOTING REINFORCING."

SECTION THRU AREAWAY (1) A1.7
 SCALE: 1/2" = 1'-0"

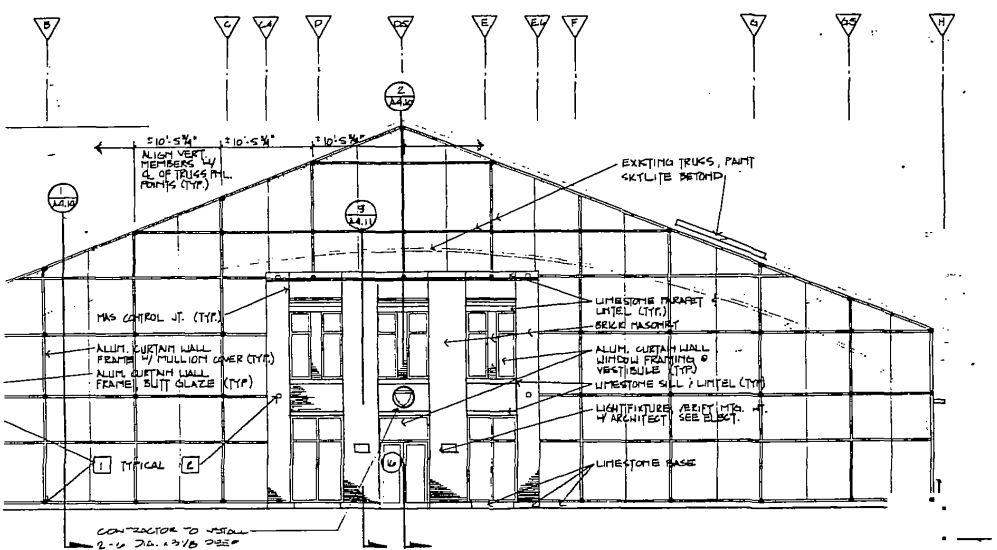

LEGEND

1 - LOCATIONS OF CURTAIN WALL CONNECTIONS TO STEEL COLUMN AND BEAM MEMBERS.

2 - LOCATIONS OF CURTAIN WALL CONNECTIONS TO CONCRETE FLOOR OR ROOF SLAB

IEO A DAILY
 PLANNING ARCHITECTURE ENGINEERING INTERIORS
 BAHR VERMEER & HÄCKER ARCHITECTS
 Union Pacific Freighthouse, Renovation/
 Dispatch Center
 NEBRASKA
 DATE: 31 MAY 88
 FILE NO.: 031887-01
 DESIGNED: DW
 DRAWN: KD RS
 CHECKED: DW
 DATE: 10 JUNE 1988
 APPROVED: DW
 DATE: 10 JUNE 1988
 APPROVED: DW

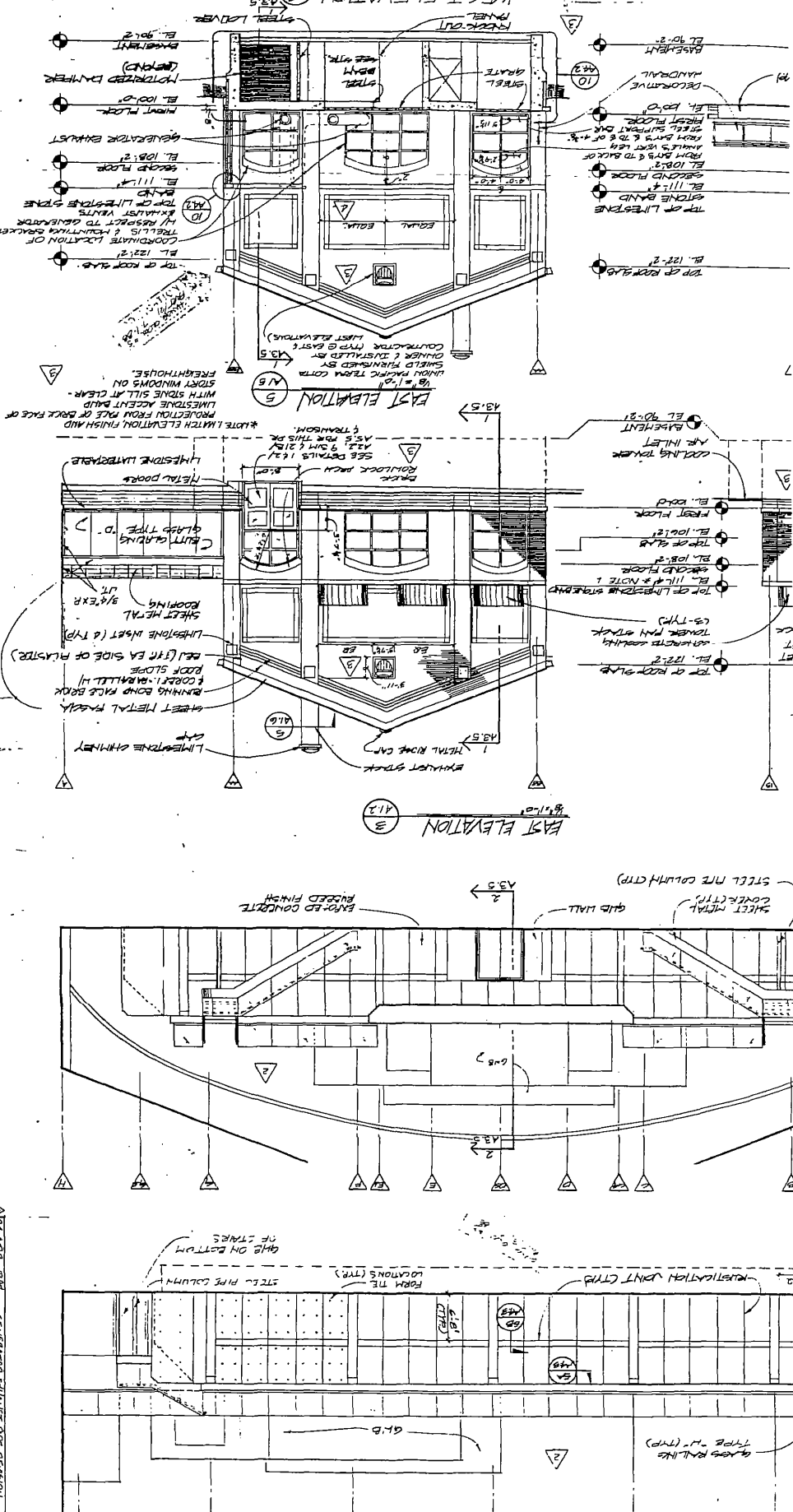

IGO A DAILY
 PLANNING
 ARCHITECTURE
 ENGINEERING
 INTERIORS

SHEET A
 DISPATCH CENTER & COMPUTER FACILITY ELEVATIONS
 DATE: 11/14/68
 TEL. NO.: 482-01
 DESIGNED BY: W.M.
 DRAWN BY: W.M.
 CHECKED BY: W.M.
 UNION PACIFIC FREIGHTHOUSE RENOVATION / DISPATCH CENTER
 OMAHA, NEBRASKA
 ARCHITECTURE: BAHR VERMEER & HAEGCKER ARCHITECTS
 ENGINEERING: IGO A DAILY
 INTERIORS: GENERATOR EXHAUST HOPE REGION

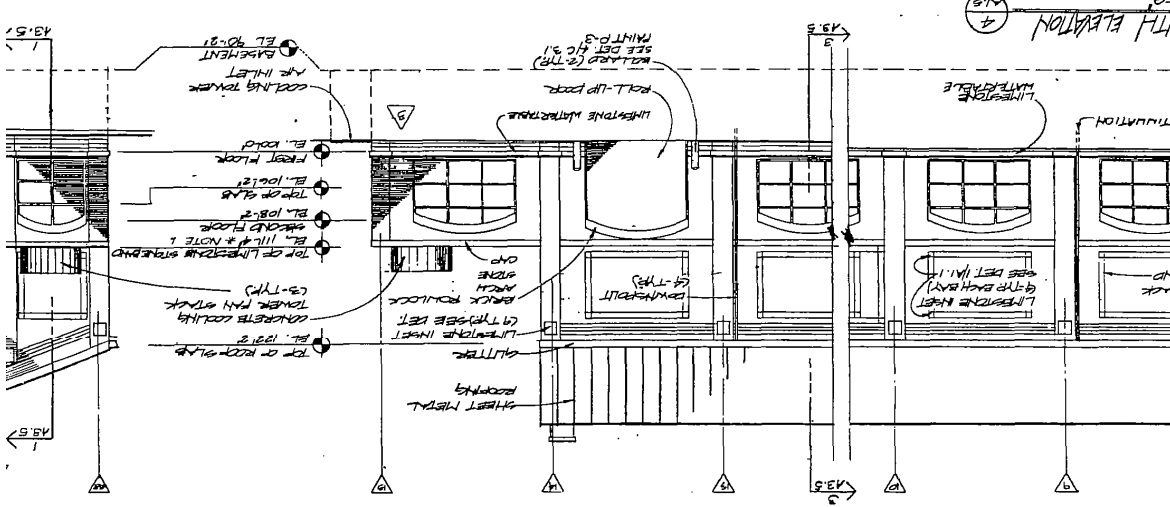
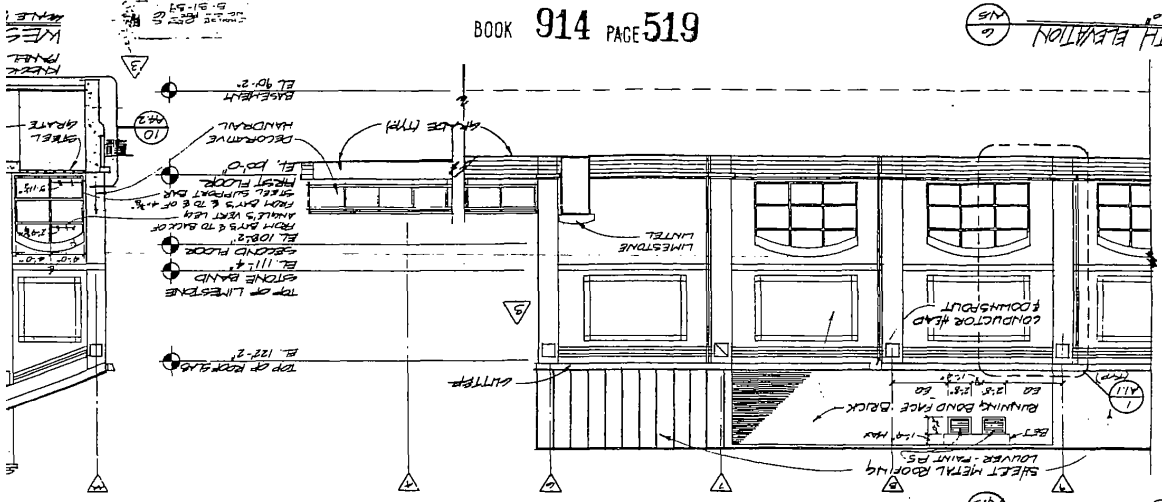

EAST ELEVATION

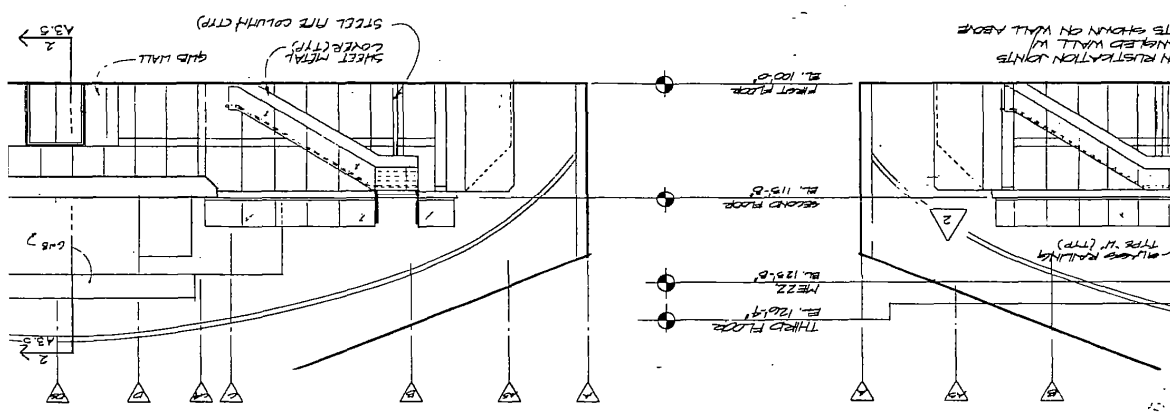

SOUTH ELEVATION

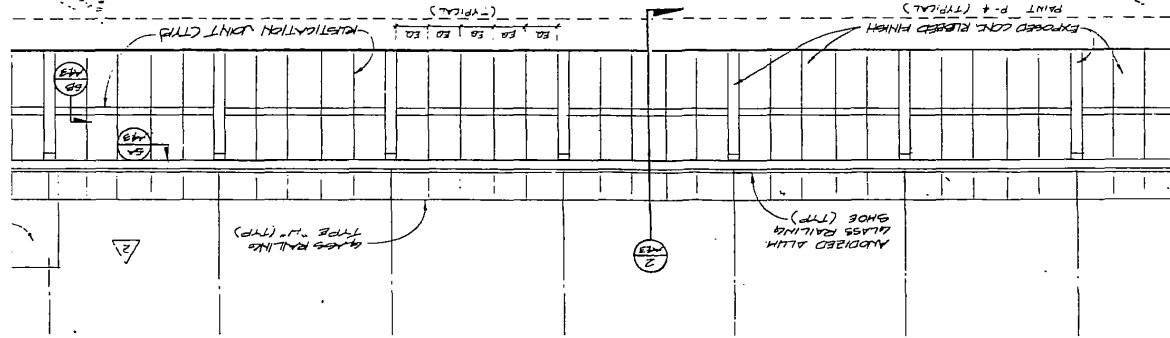

131	131
132	132
133	133
134	134
135	135
136	136
137	137
138	138
139	139
140	140
141	141
142	142
143	143
144	144
145	145
146	146
147	147
148	148
149	149
150	150

